



Booklet available in English on
Heft in deutscher Sprache erhältlich auf
Livret disponible en français sur
Libretto disponibile in italiano su
Folleto disponibile en español en
如需中文版手册, 请访问





WELCOME

What started as a nights and weekends passion project for our designers in 2007 has now grown into a vibrant downtown filled with beautiful architecture, rich interiors, clever brick usage and an impressive population of happy minifigures. And what better way to celebrate 15 years of Modular Building than by creating one of the models most-often requested by fans.

Welcome to the beautiful, historic **Boutique Hotel!** Inspired by turn-of-the-century European architecture, the unique wedge-shaped structure showcases a myriad of elegant forms and delicate details. It's also packed with small stories and subtle references to earlier models in the Modular Building range. See how many you can spot!





From left to right:

Michael Psiaki
Astrid Graabæk
Wesley Alan Talbott
Torben Kidde Skov
Anderson Ward Grubb
Chris McVeigh
Jamie Berard

It's been an exciting 15 years of Modular Building! Here are all the models and many of the designers who made it happen.



Anderson Ward Grubb
Designer of the 10297 Boutique Hotel

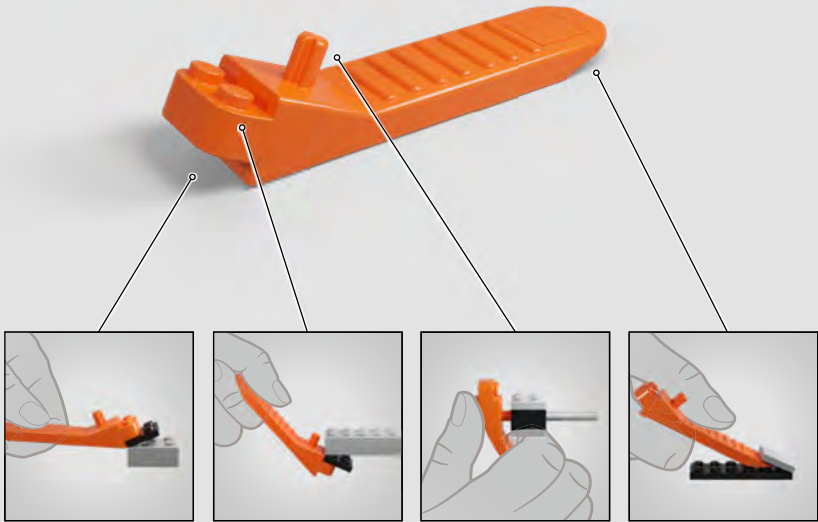
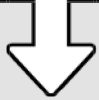
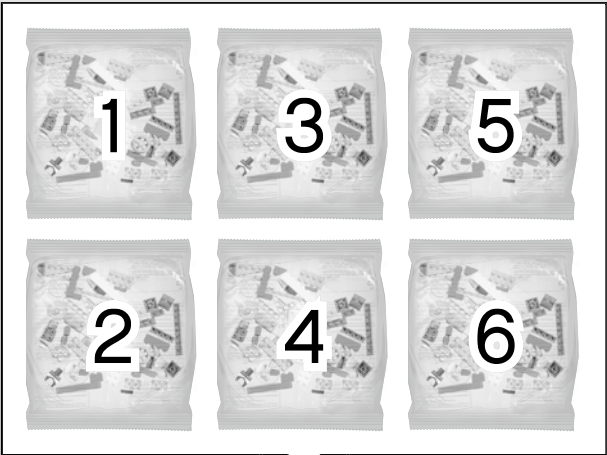

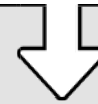
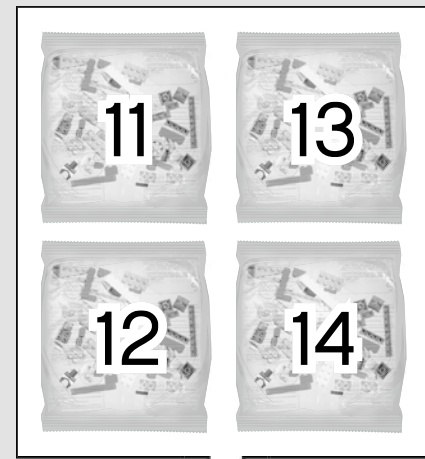
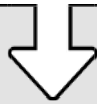
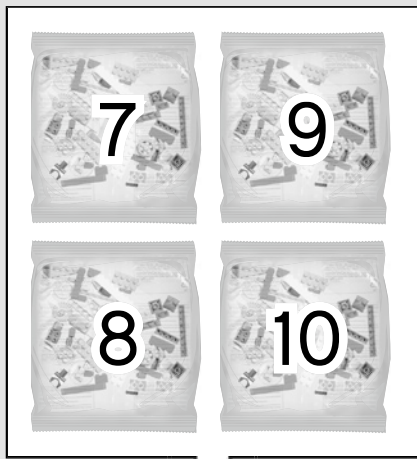

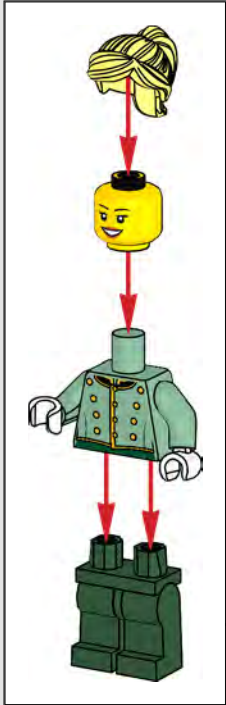
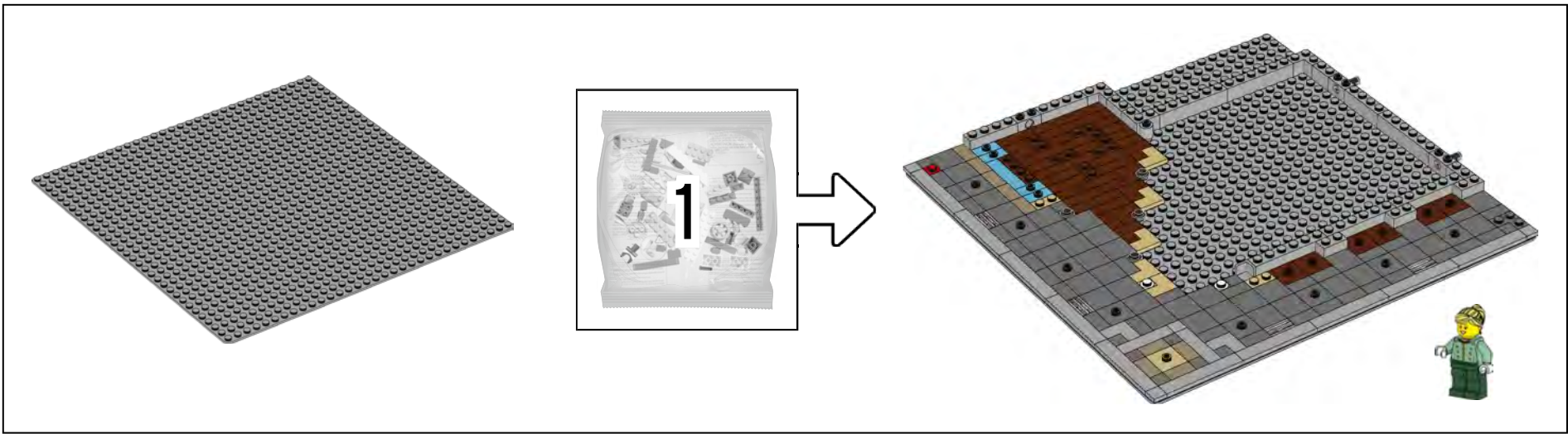

Looking for things to do during your stay?
Just ask the Receptionist about her favourite
shop within the 10211 Grand Emporium set,
or the best meal at Chez Albert.

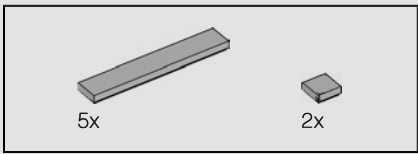

1

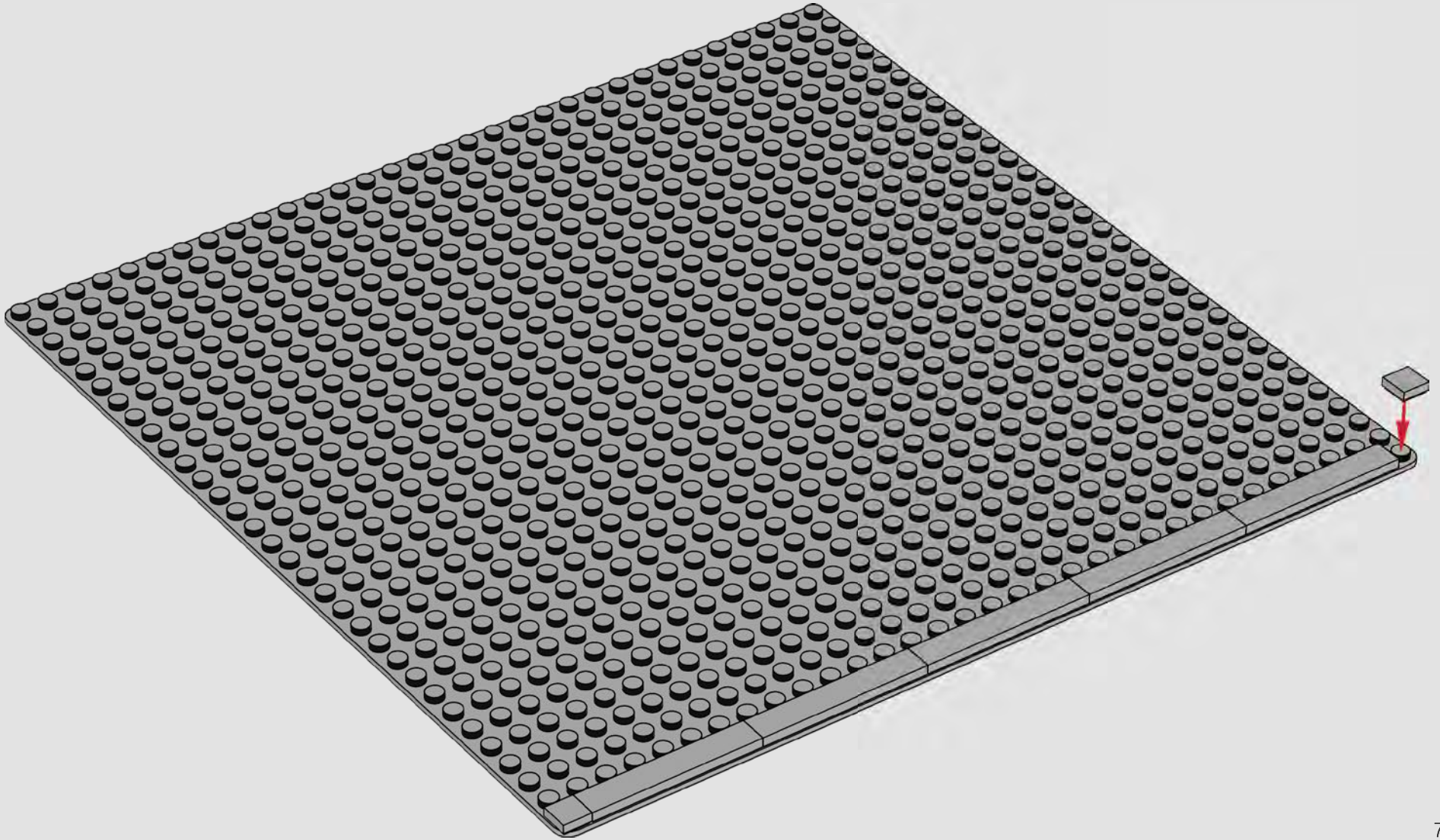

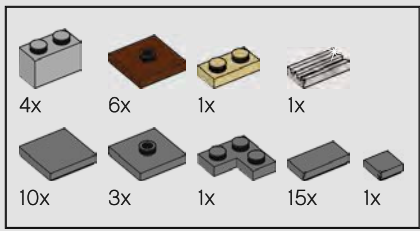

2

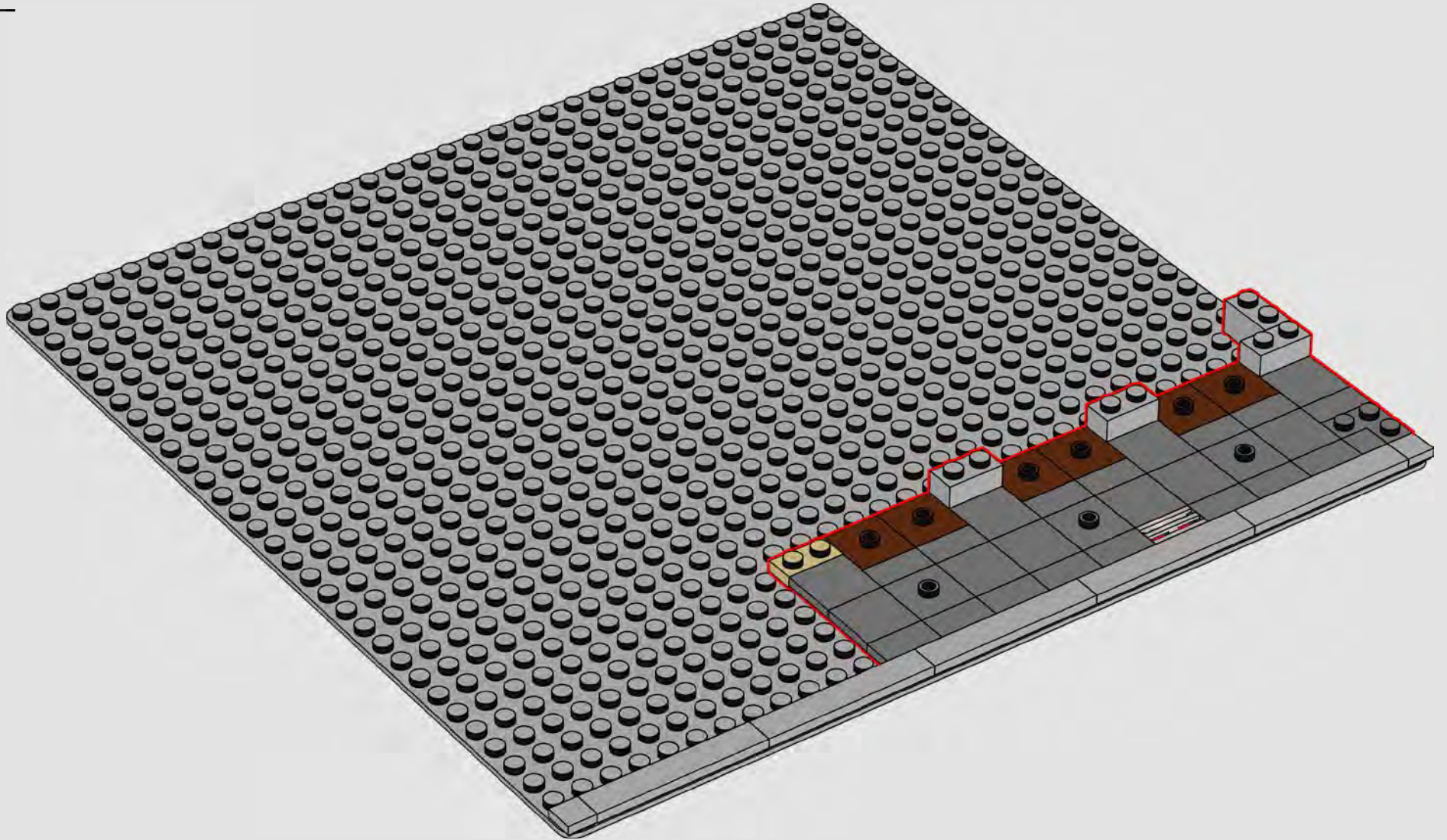

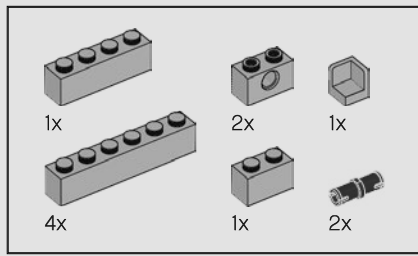

3

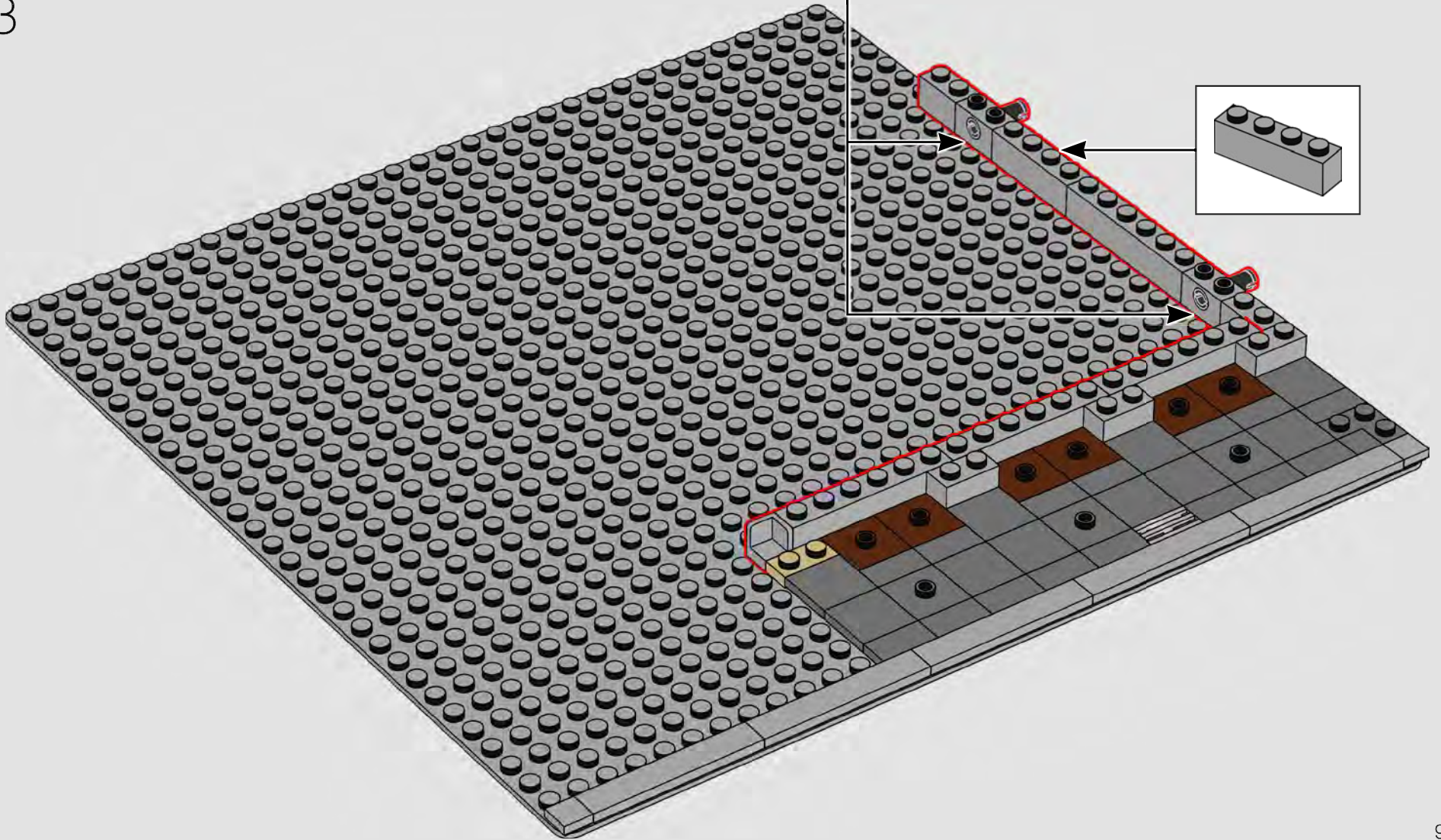
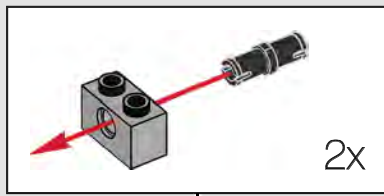

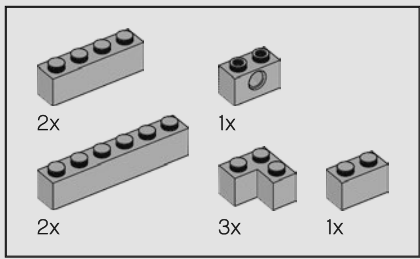

4

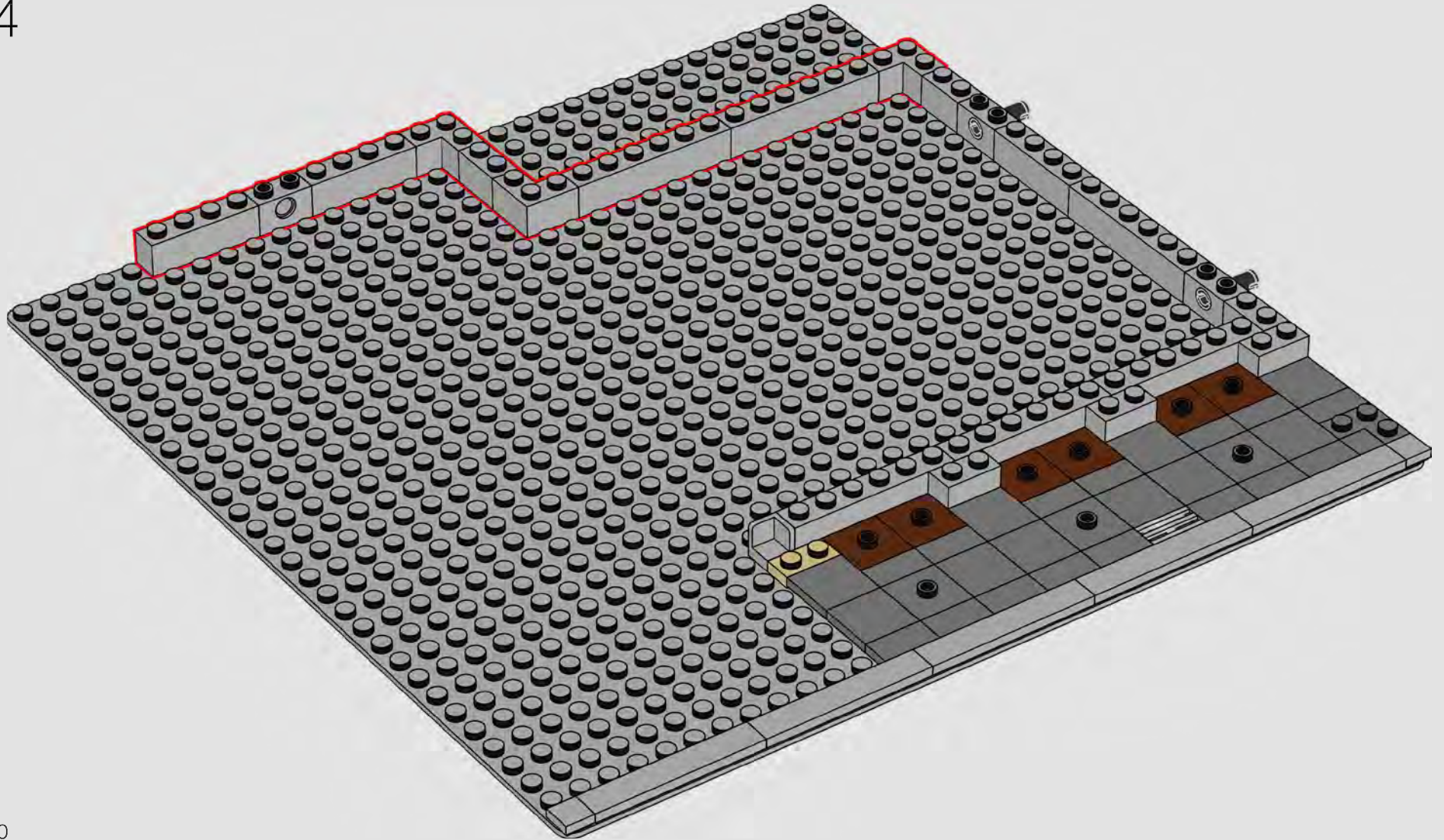

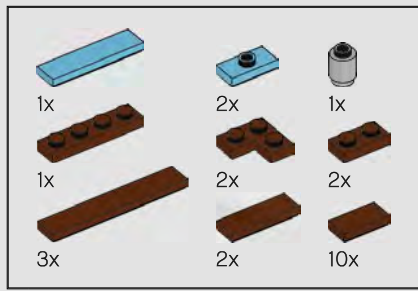

5

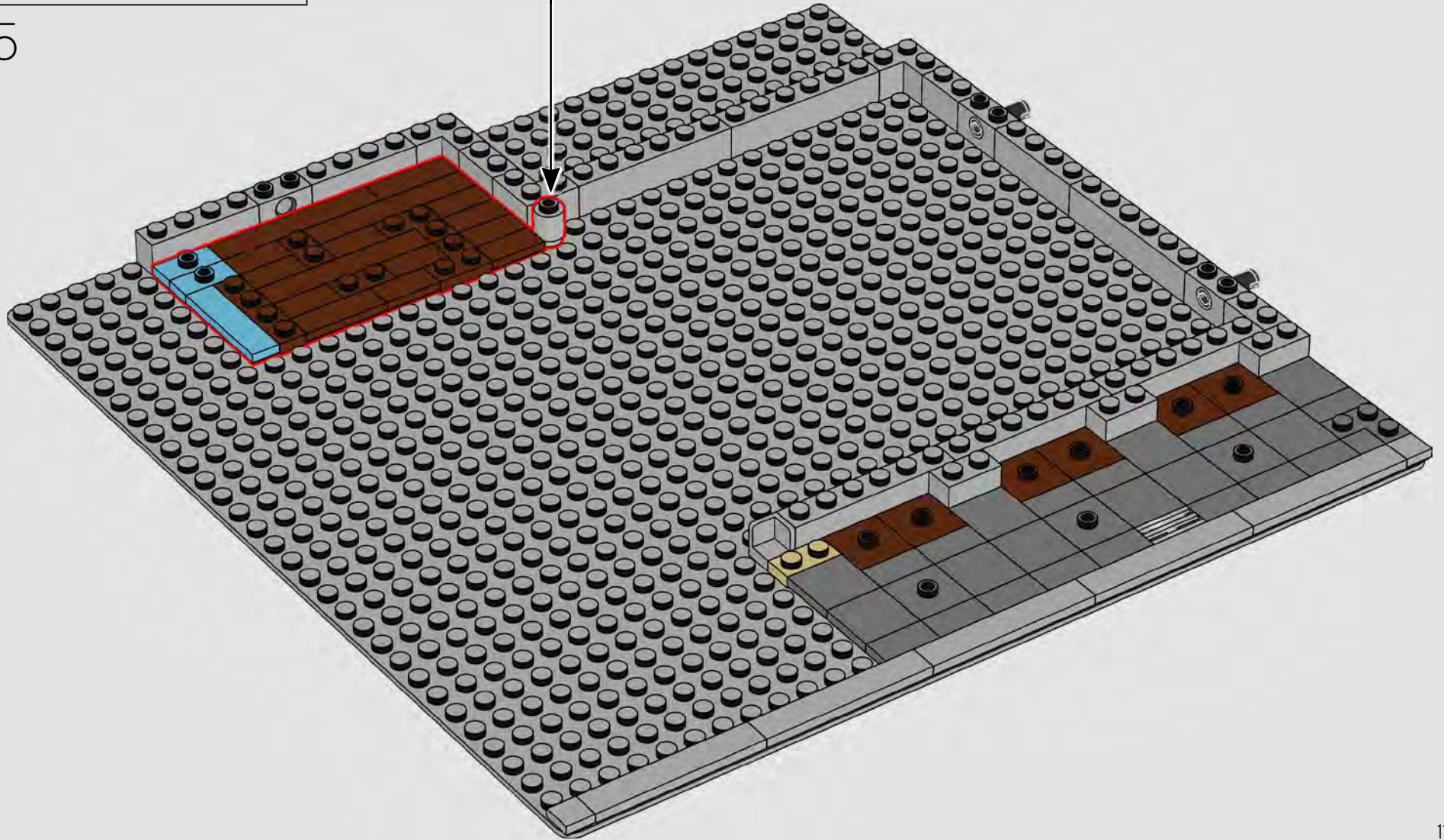

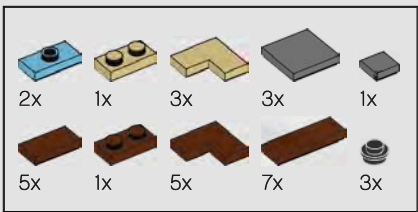

6

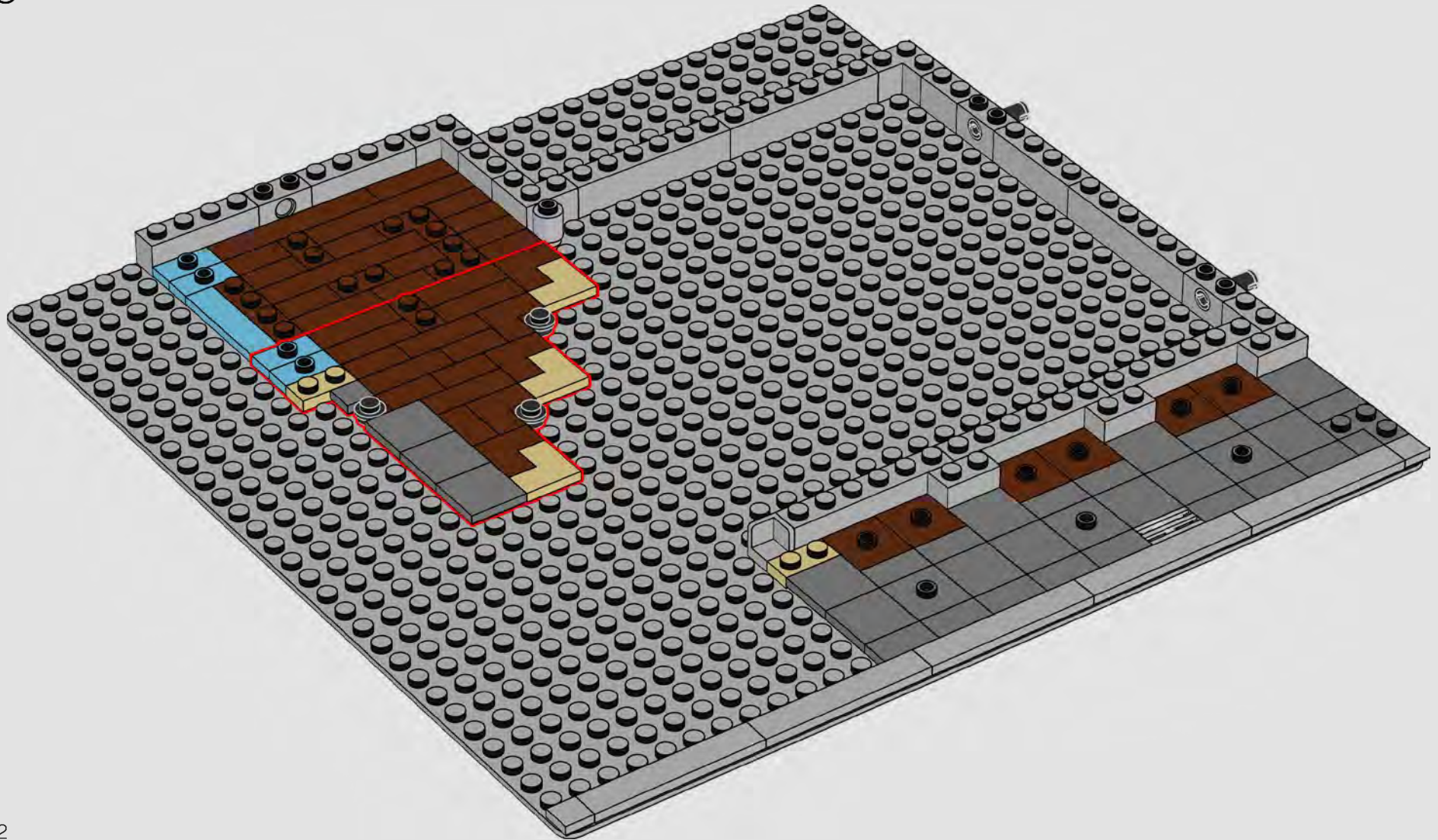

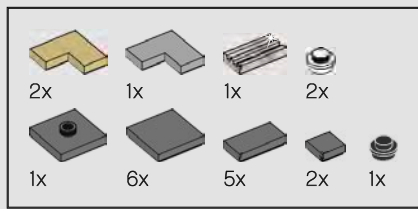

7

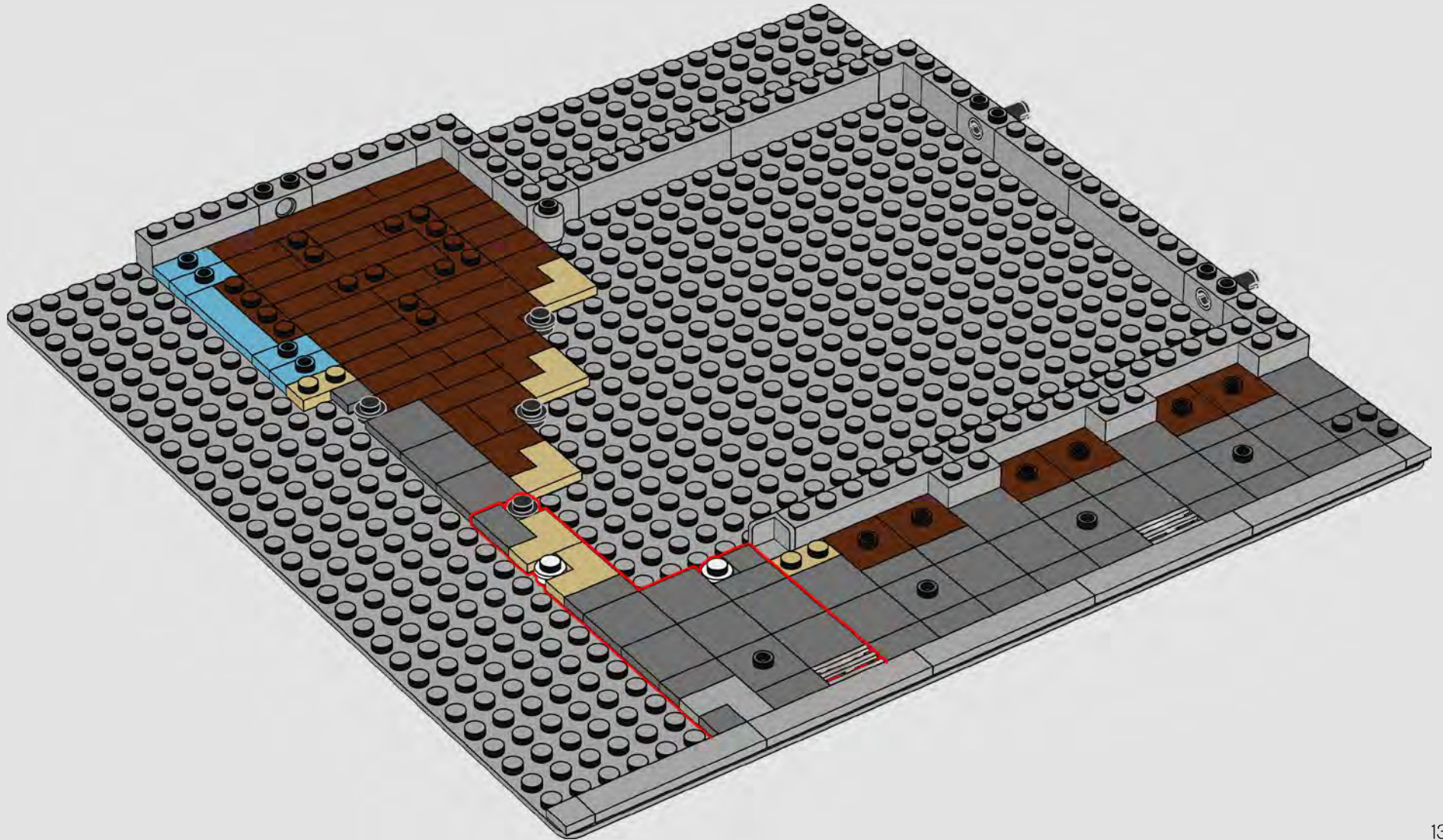

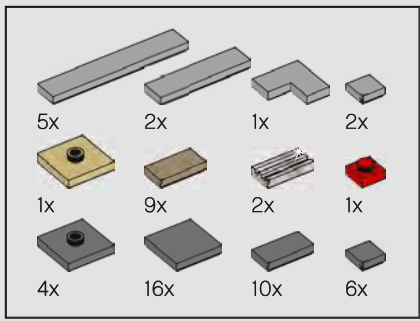

8

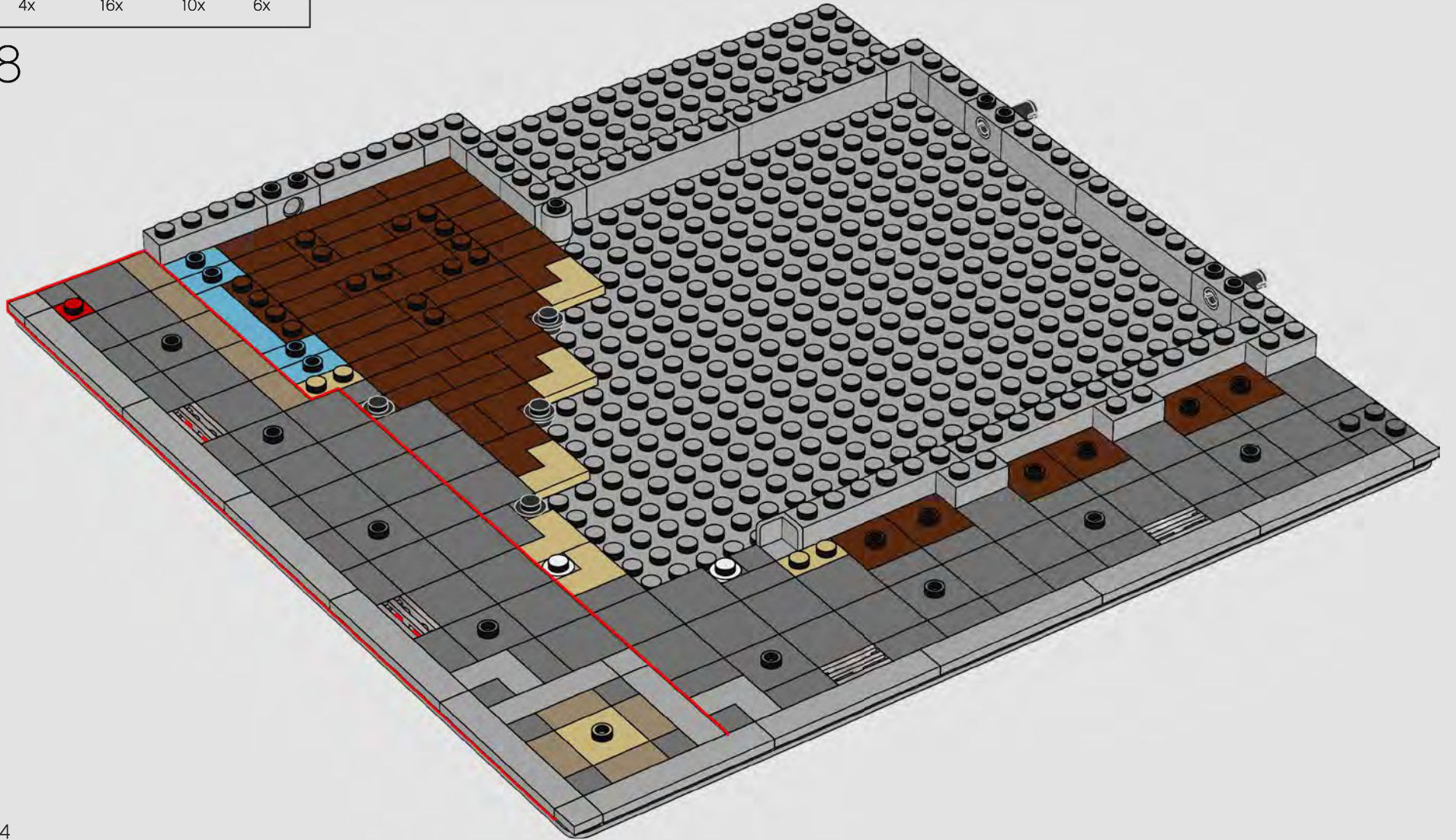

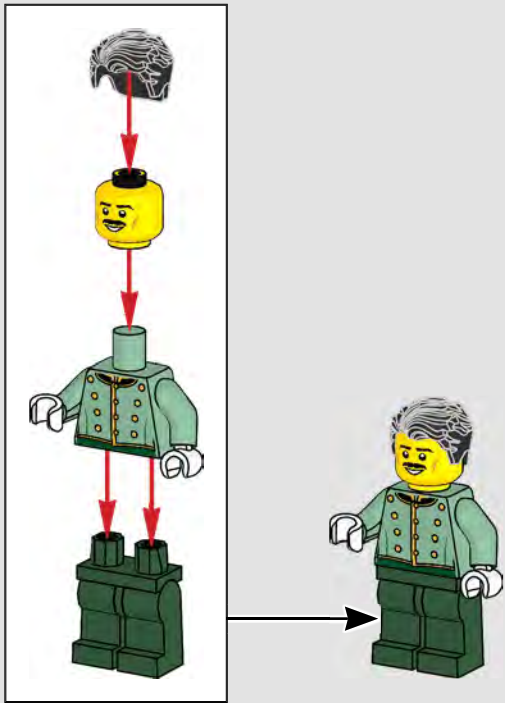
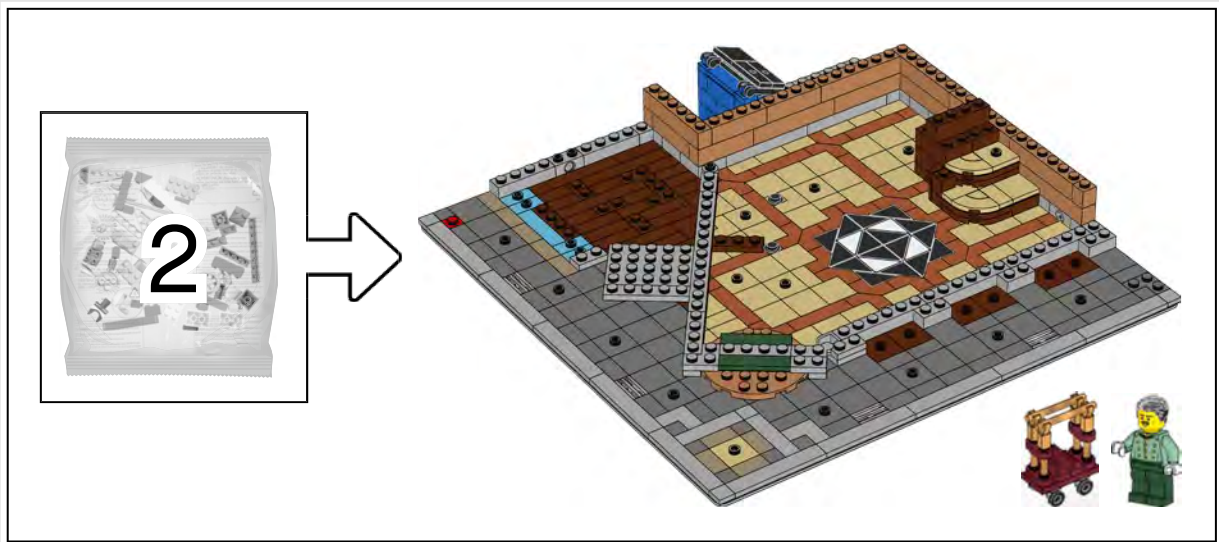

The Bellboy will happily help carry your luggage up the Hotel's stairs to your room.

Don't forget to give him a tip! 15

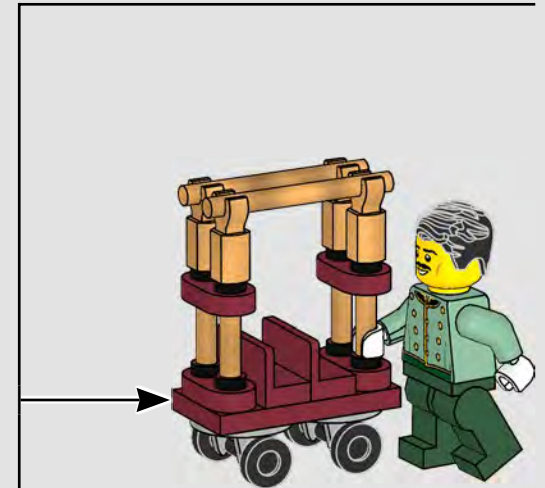
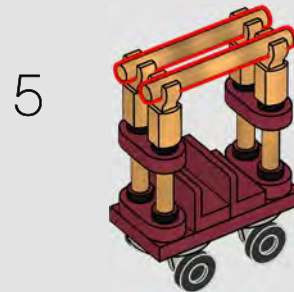
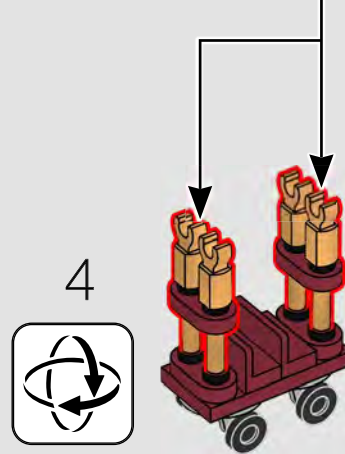
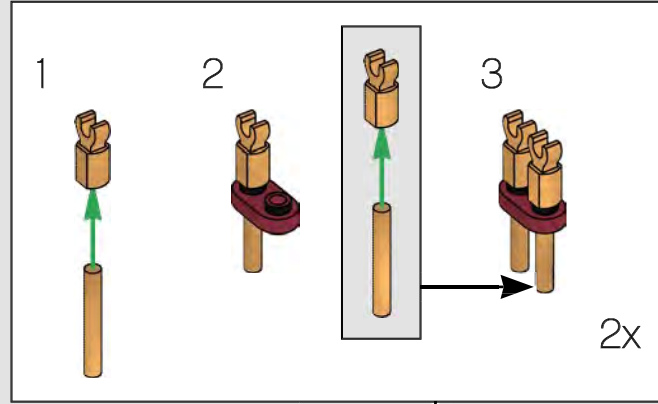
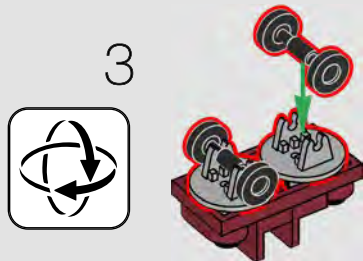
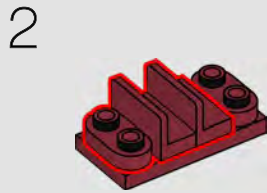
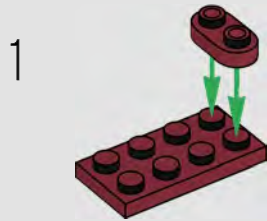
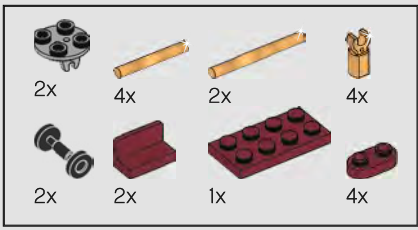

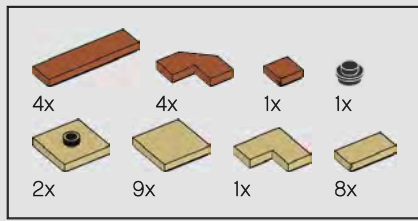

9

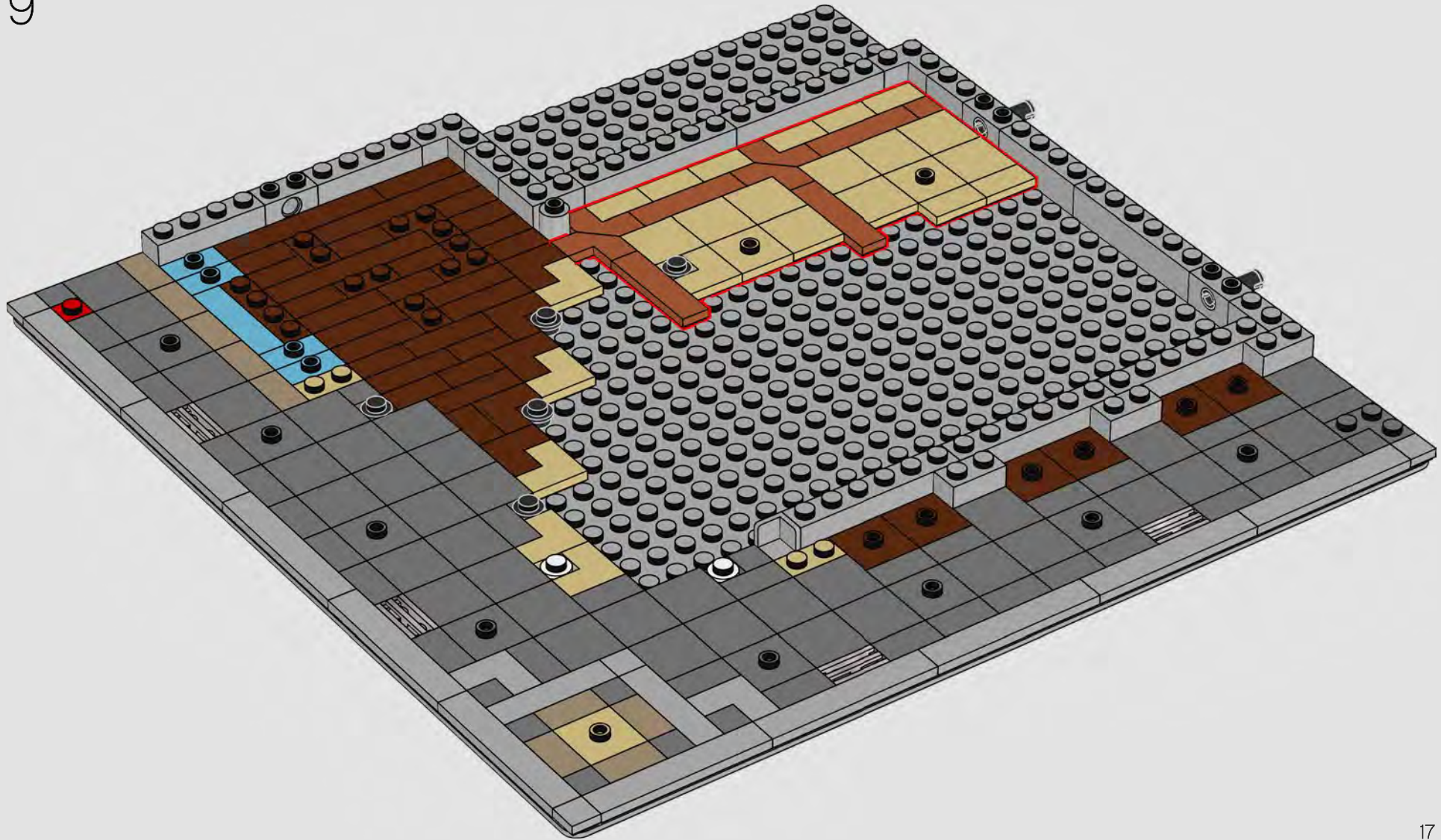

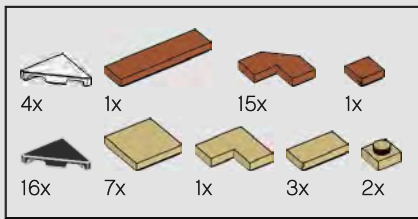

11

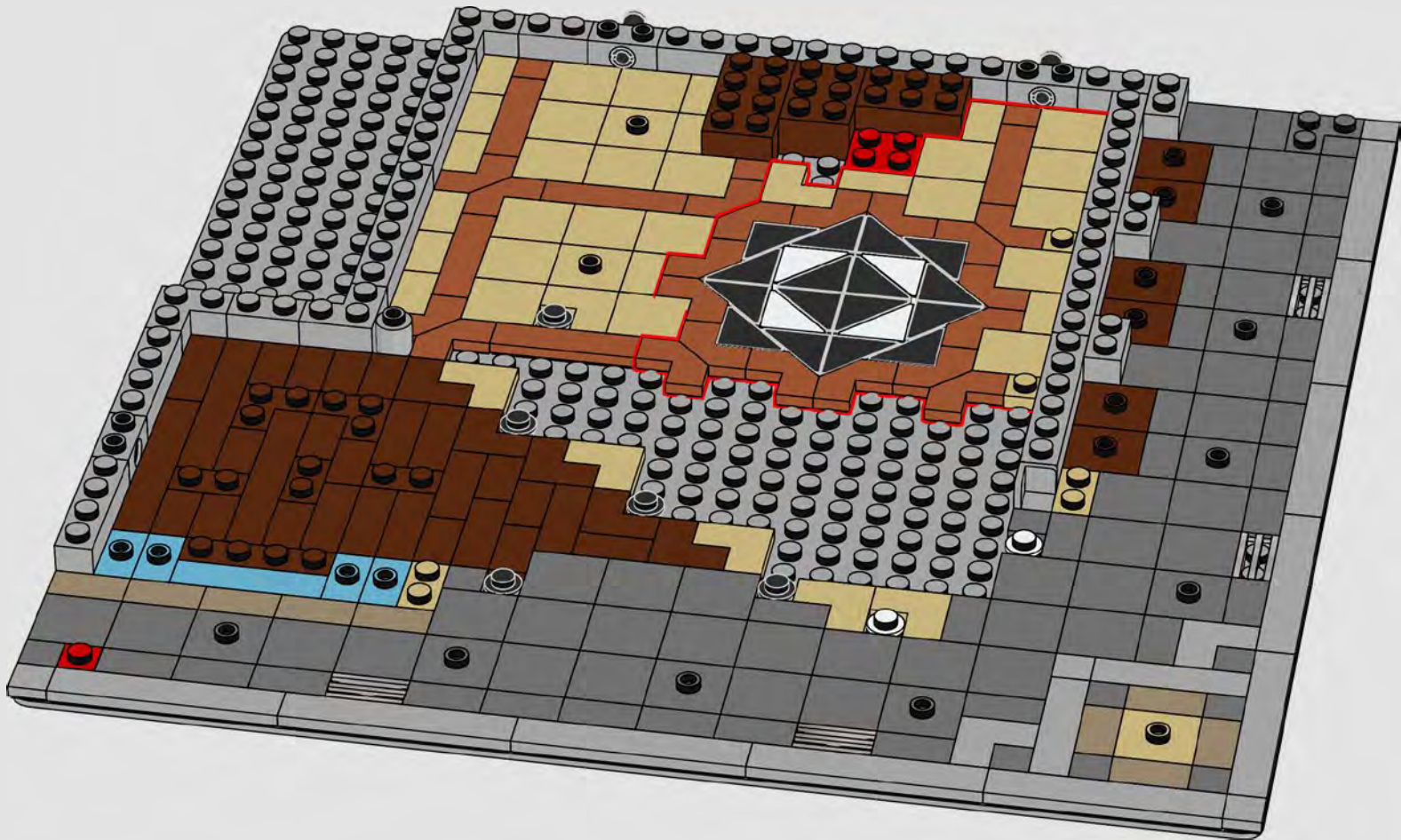

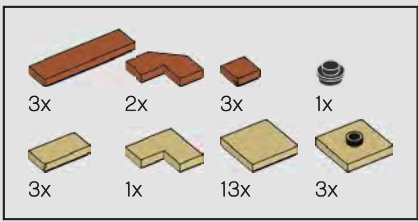

12

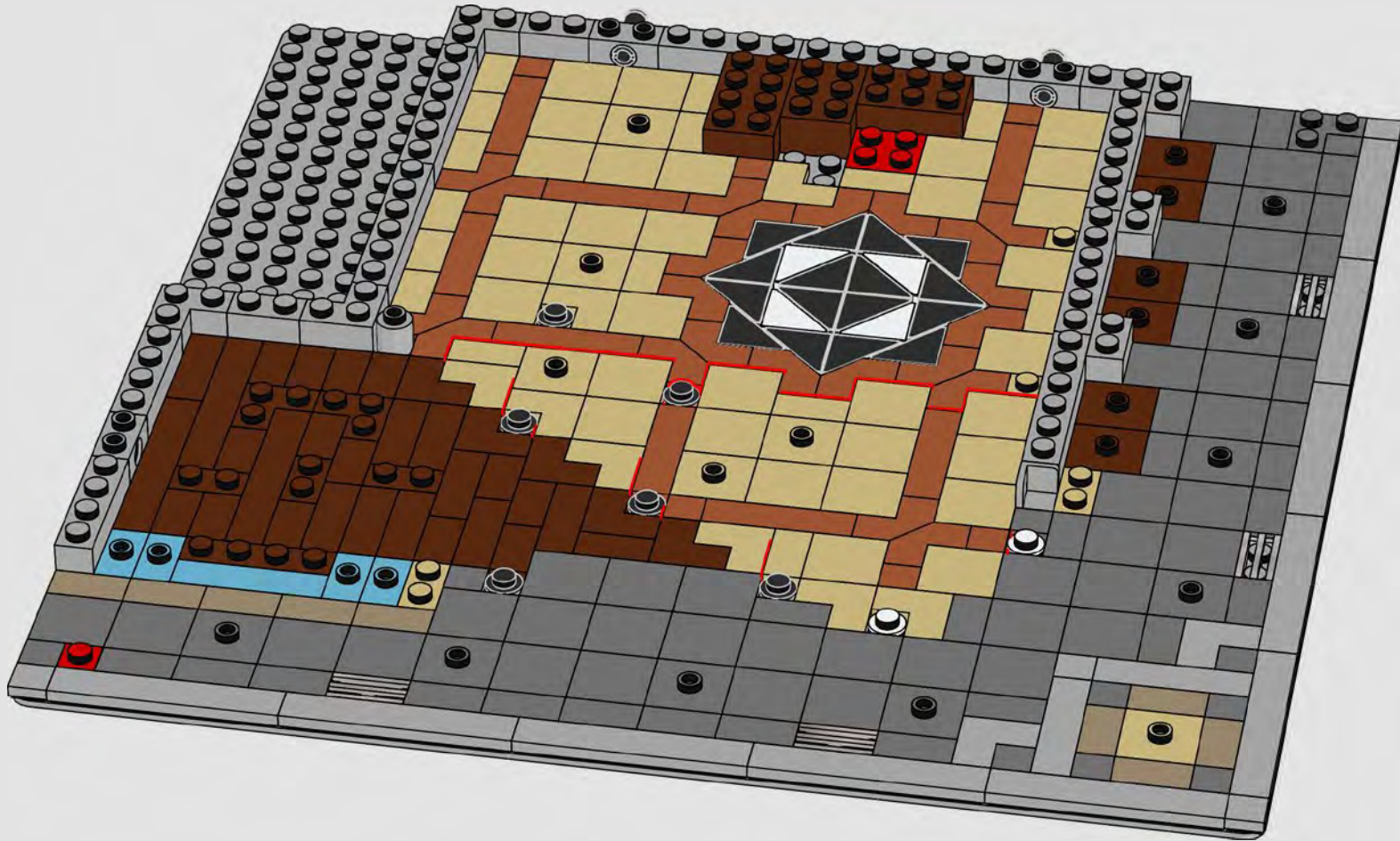

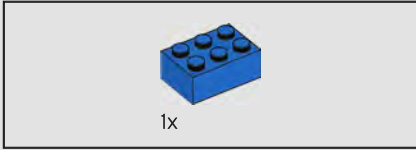
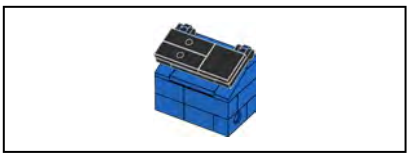

14

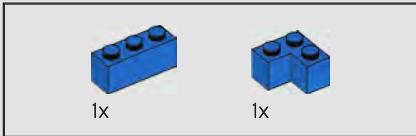
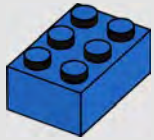

15

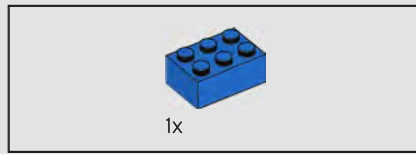
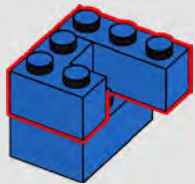

16

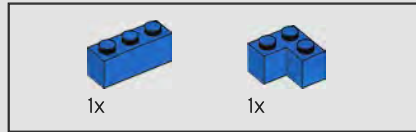
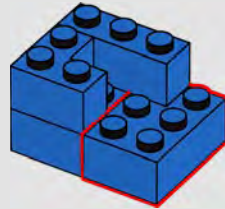

17

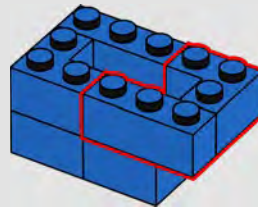

18

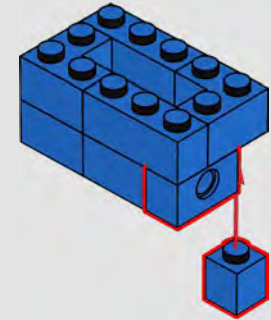

19

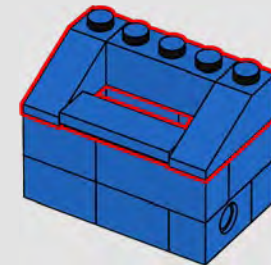

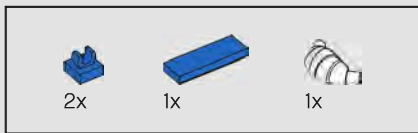

20

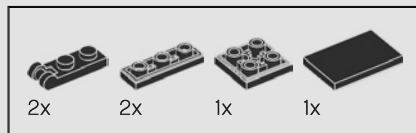
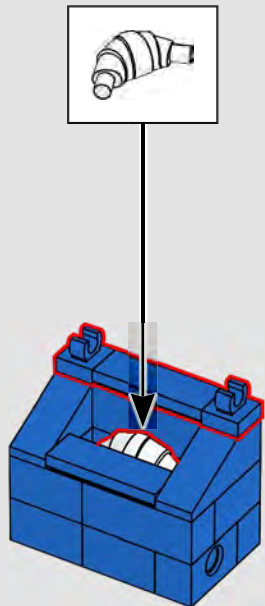

21

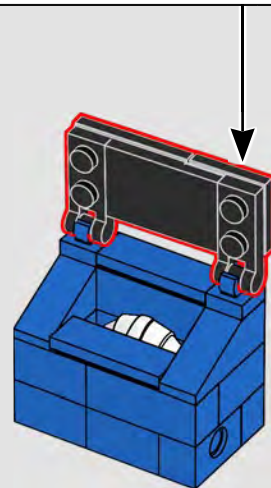
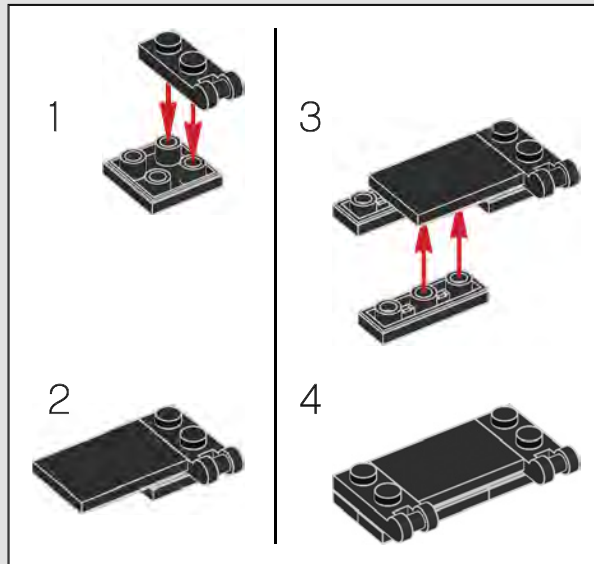

22

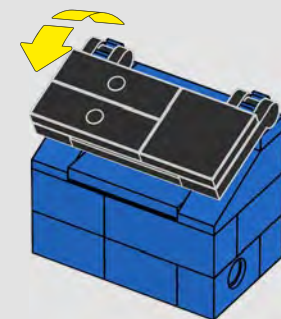

This croissant was found at the Parisian Restaurant in the 10243 set ... but why would anyone want a mouldy white croissant?

23

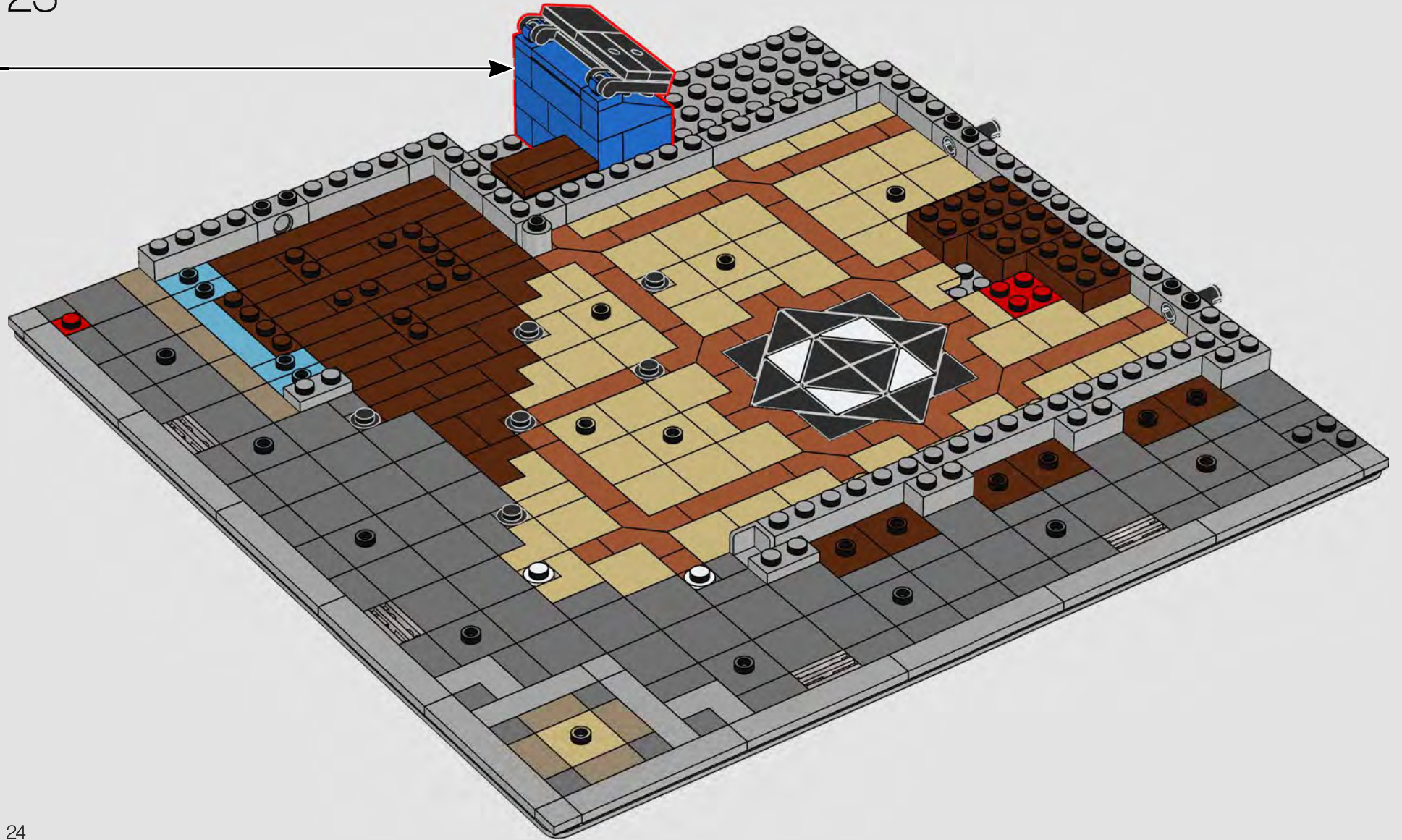

24

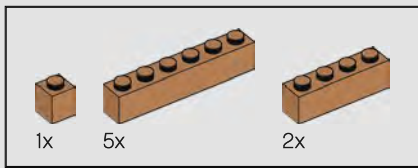

24

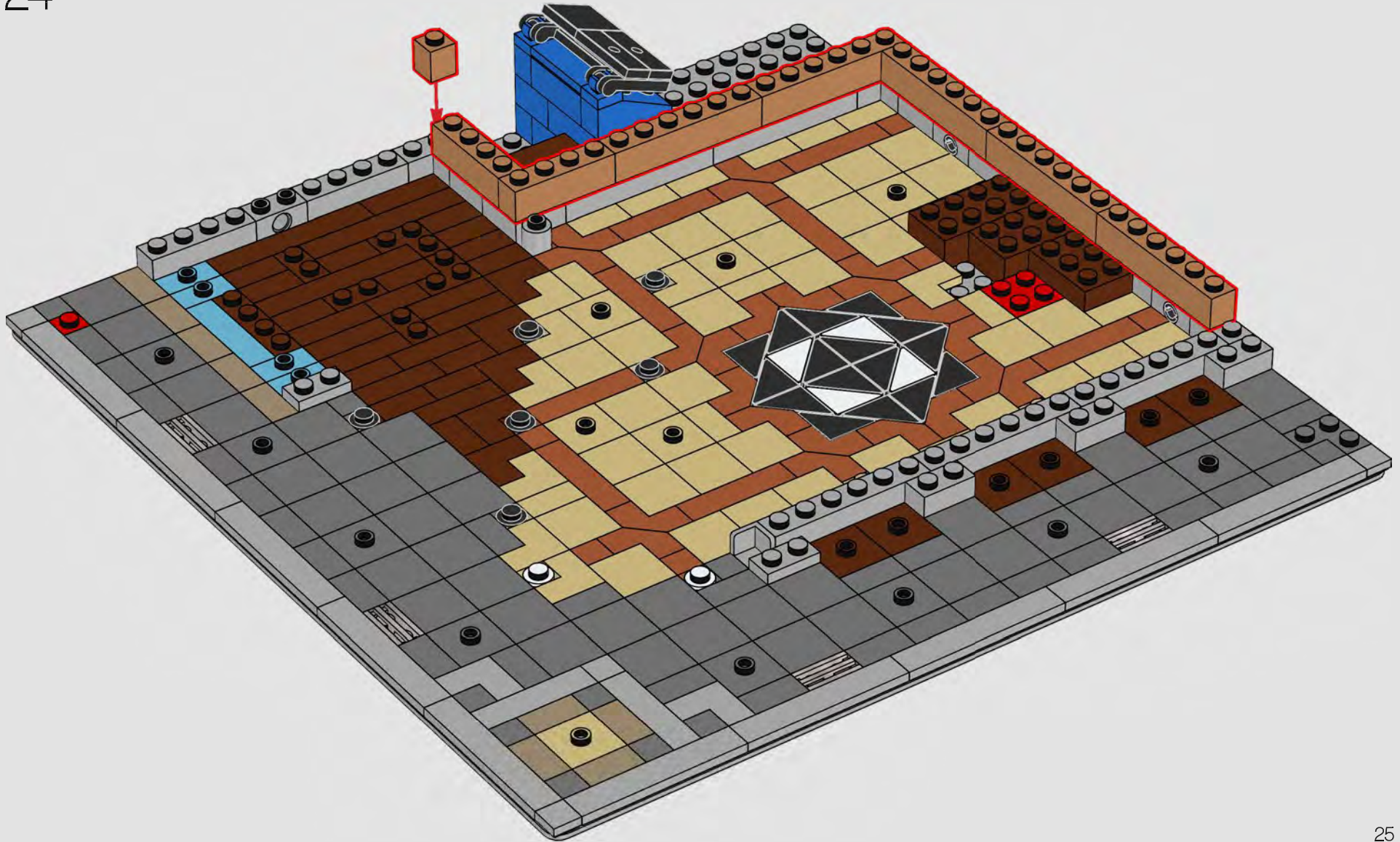

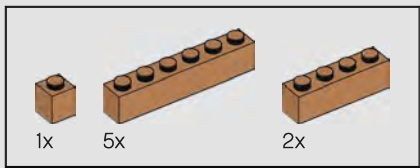

25

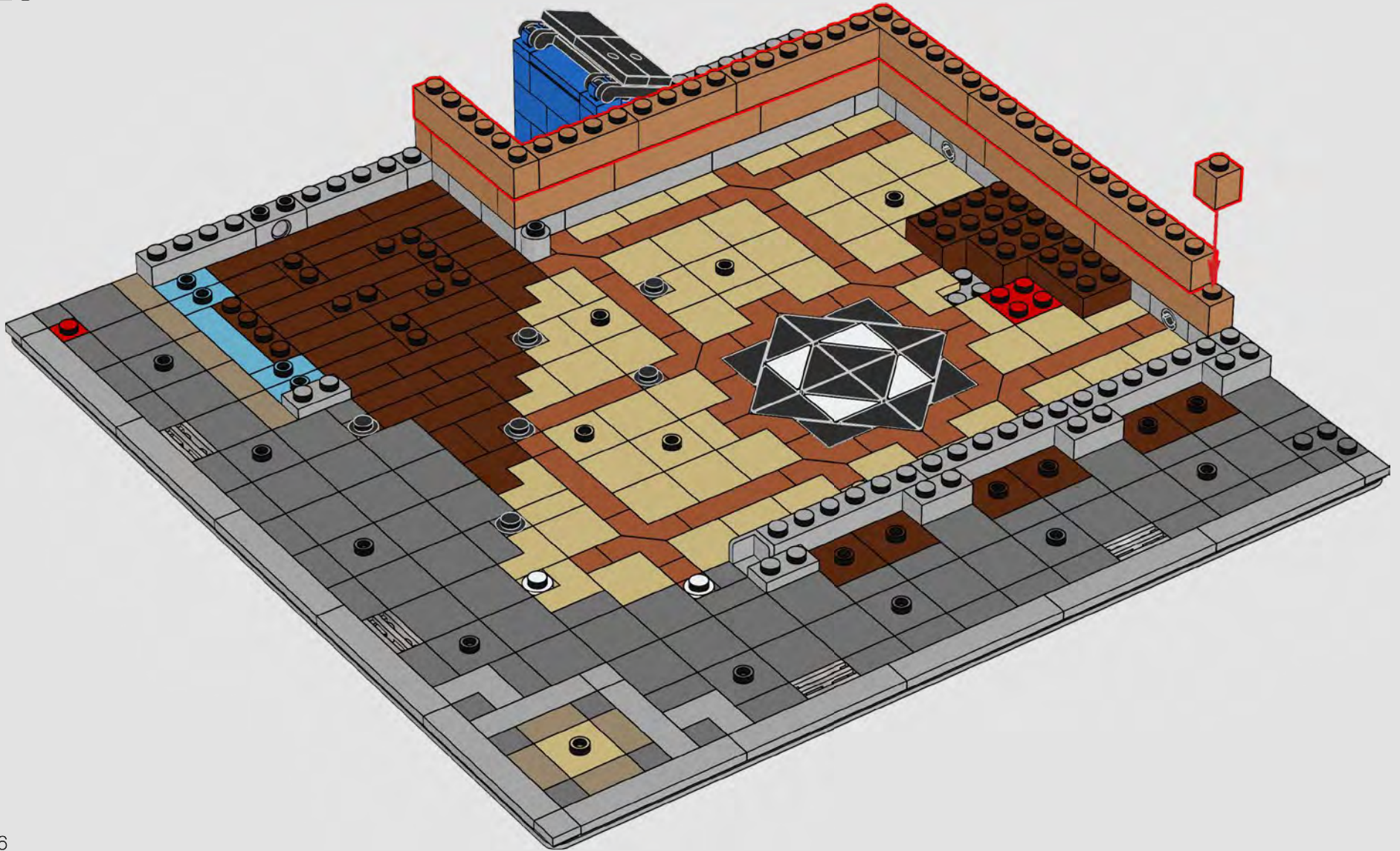

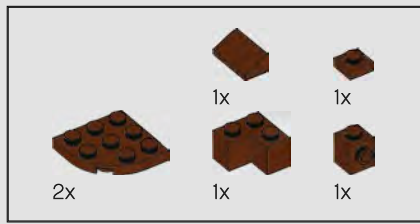

26

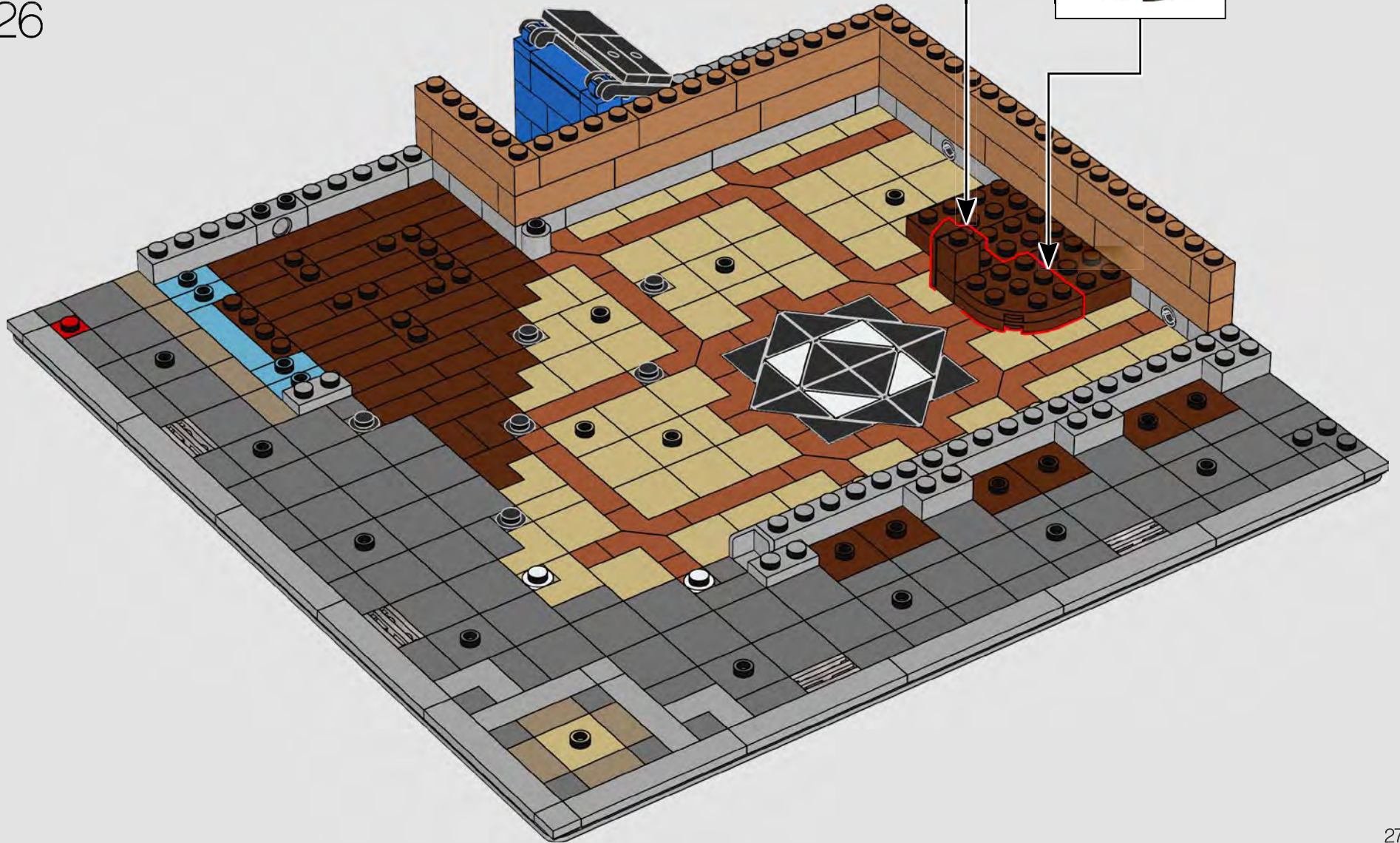
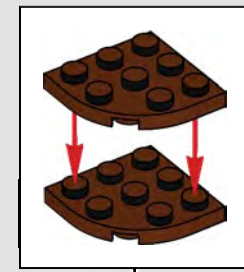
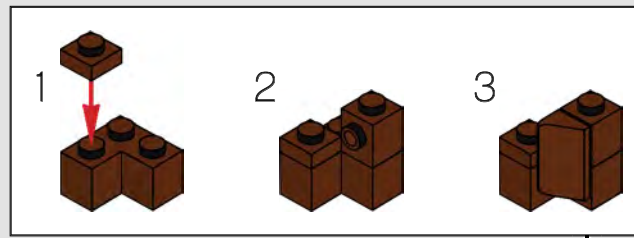

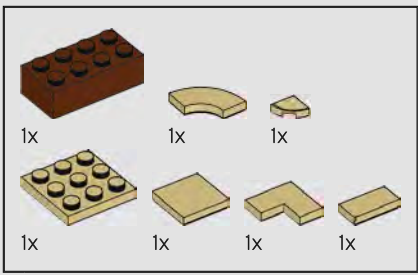

27

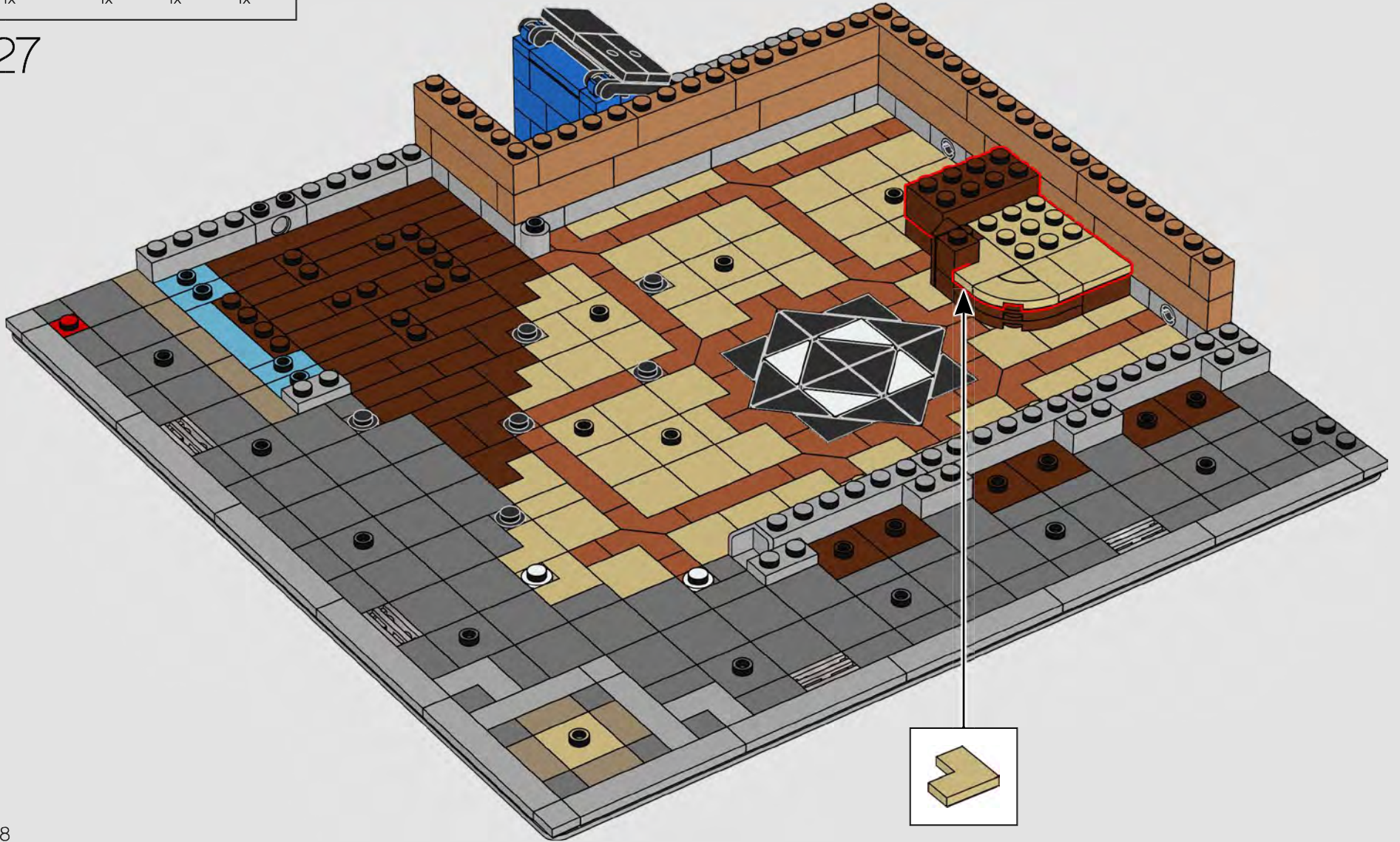

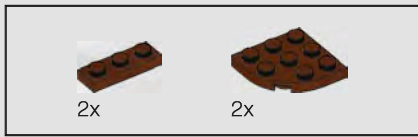

28

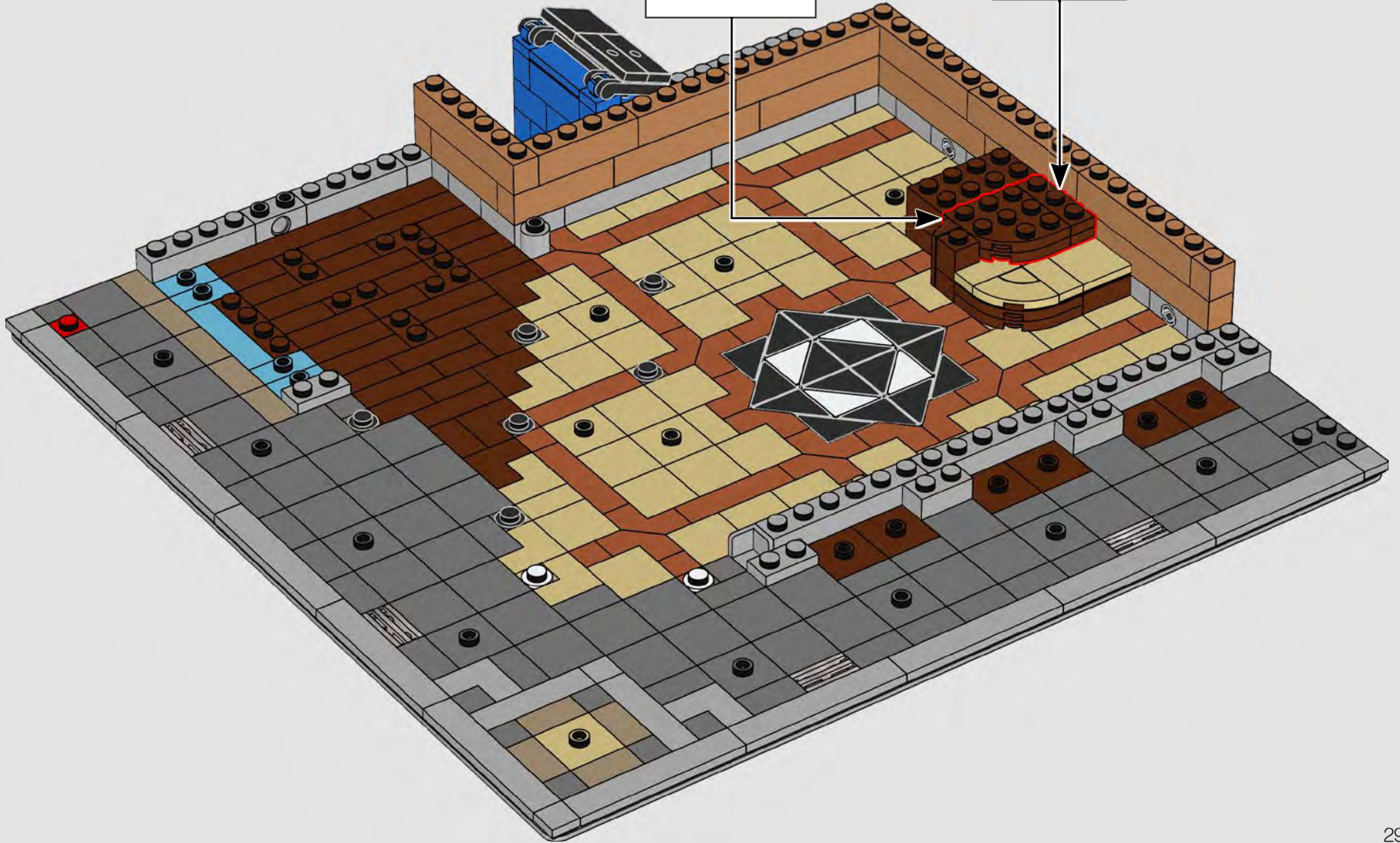
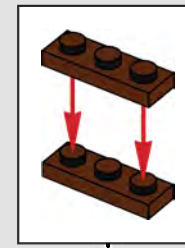
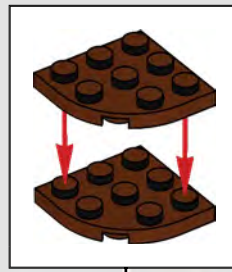

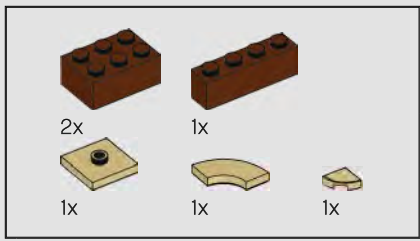

29

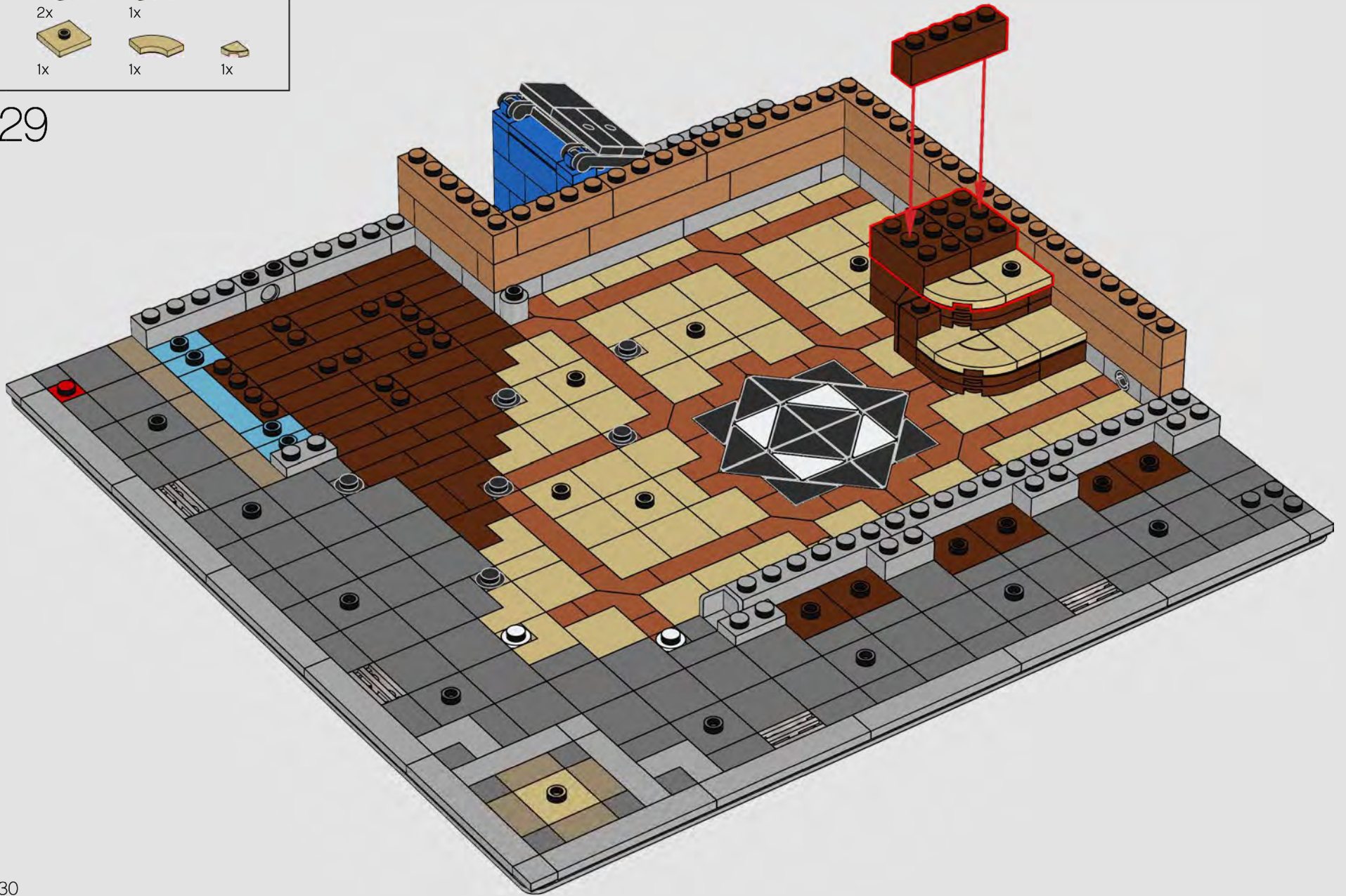

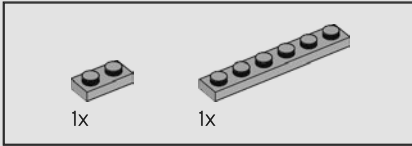
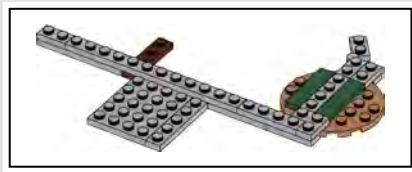

30

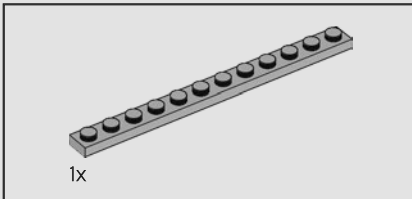
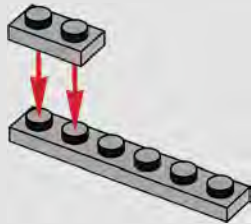

31

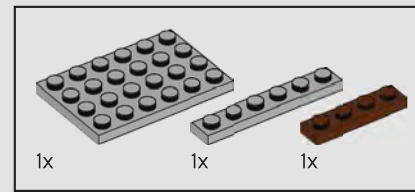
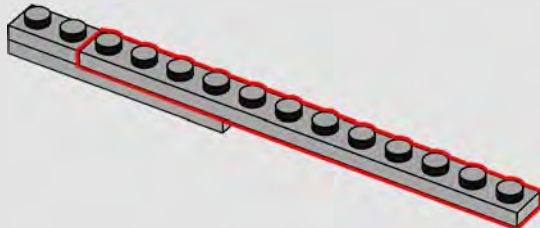

32

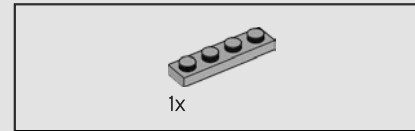
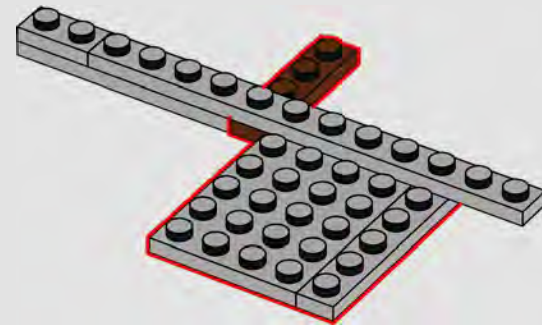

33

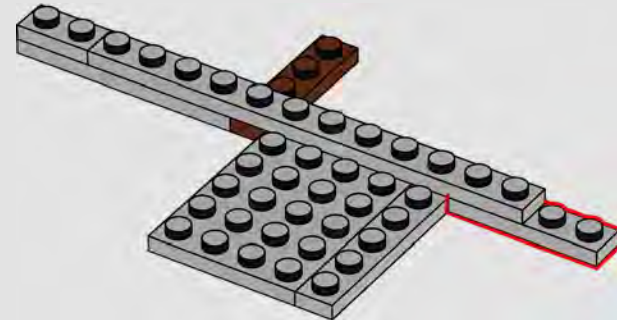

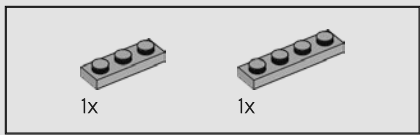

34

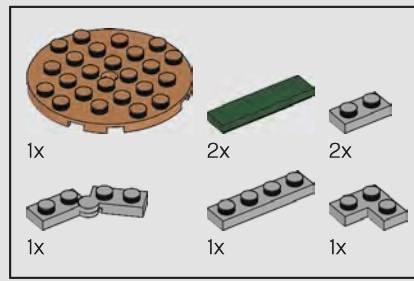
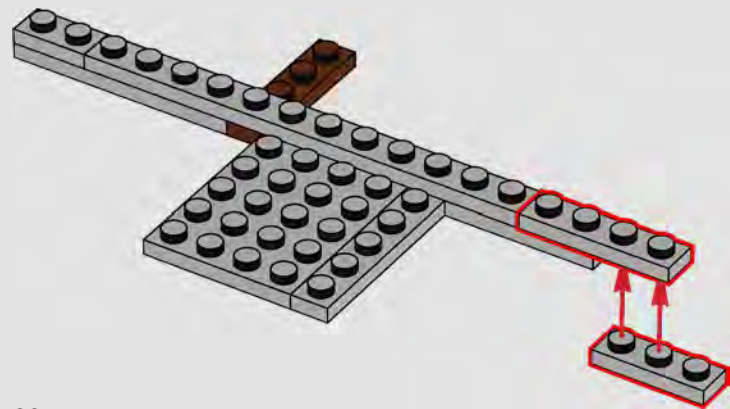

35

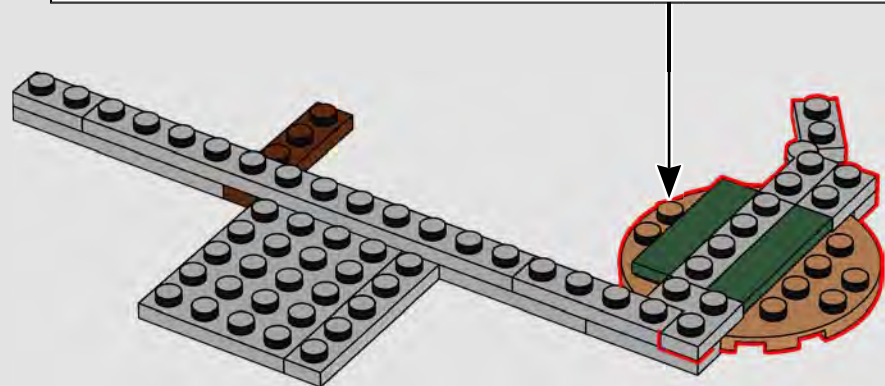
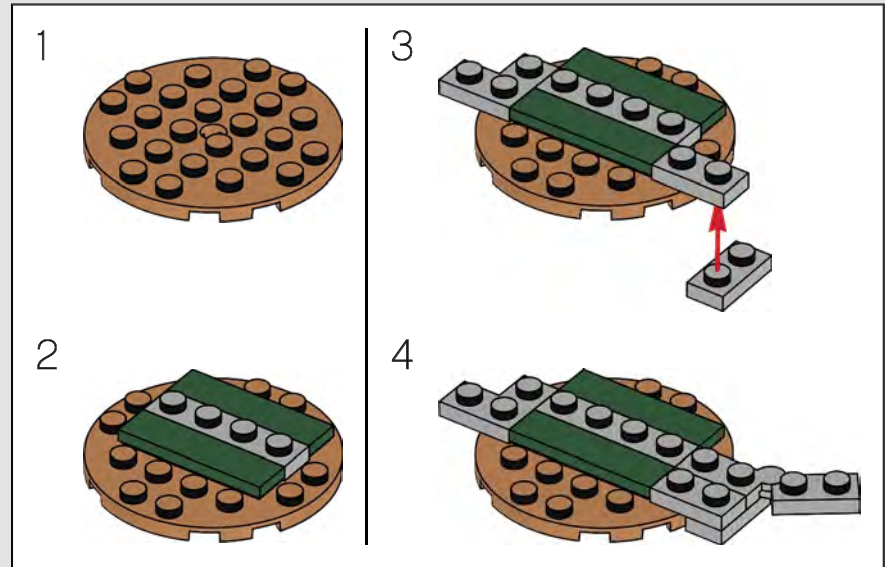

36

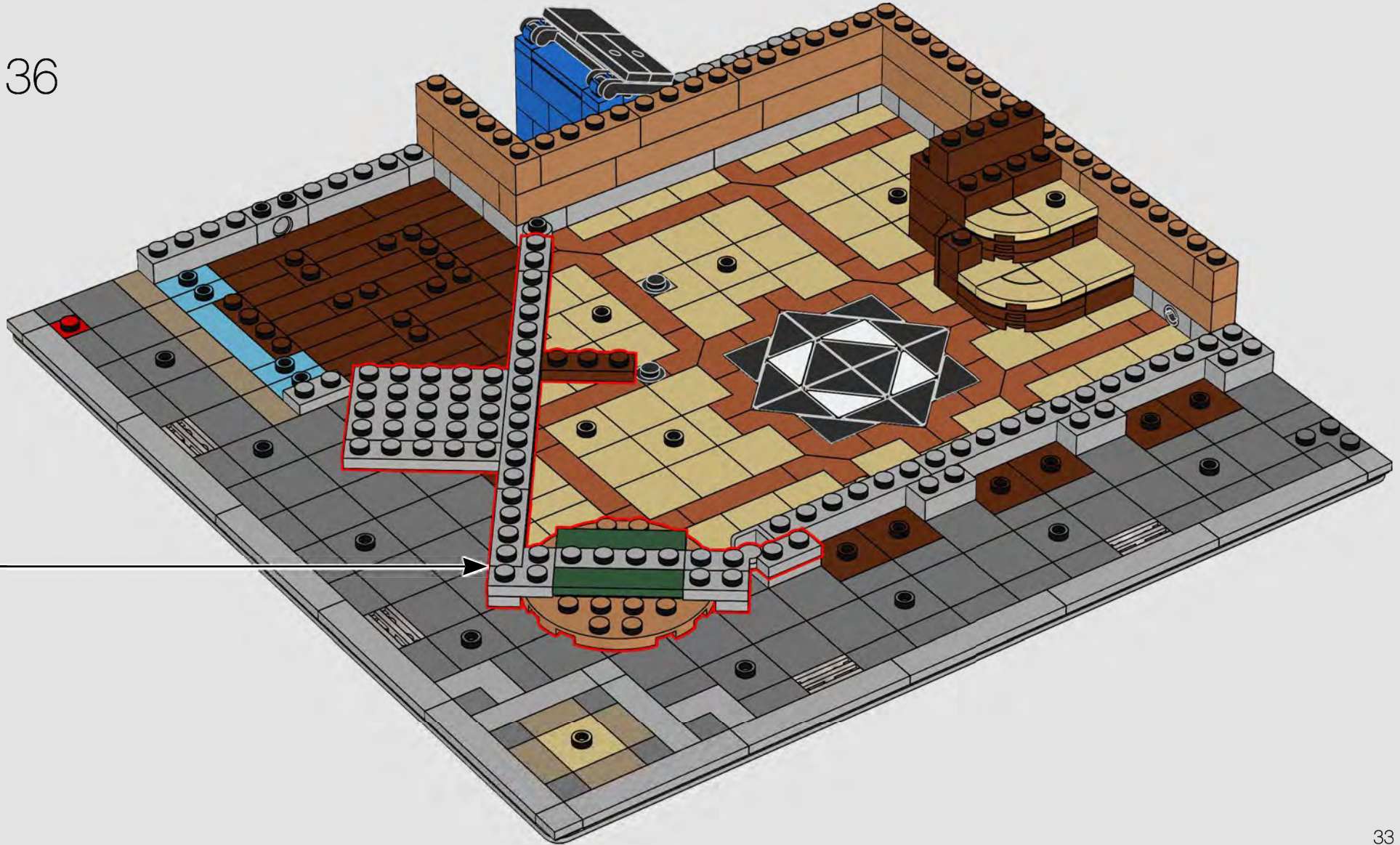

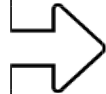

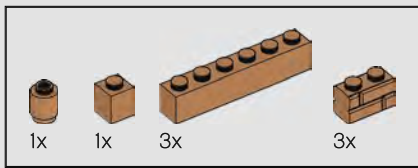

37

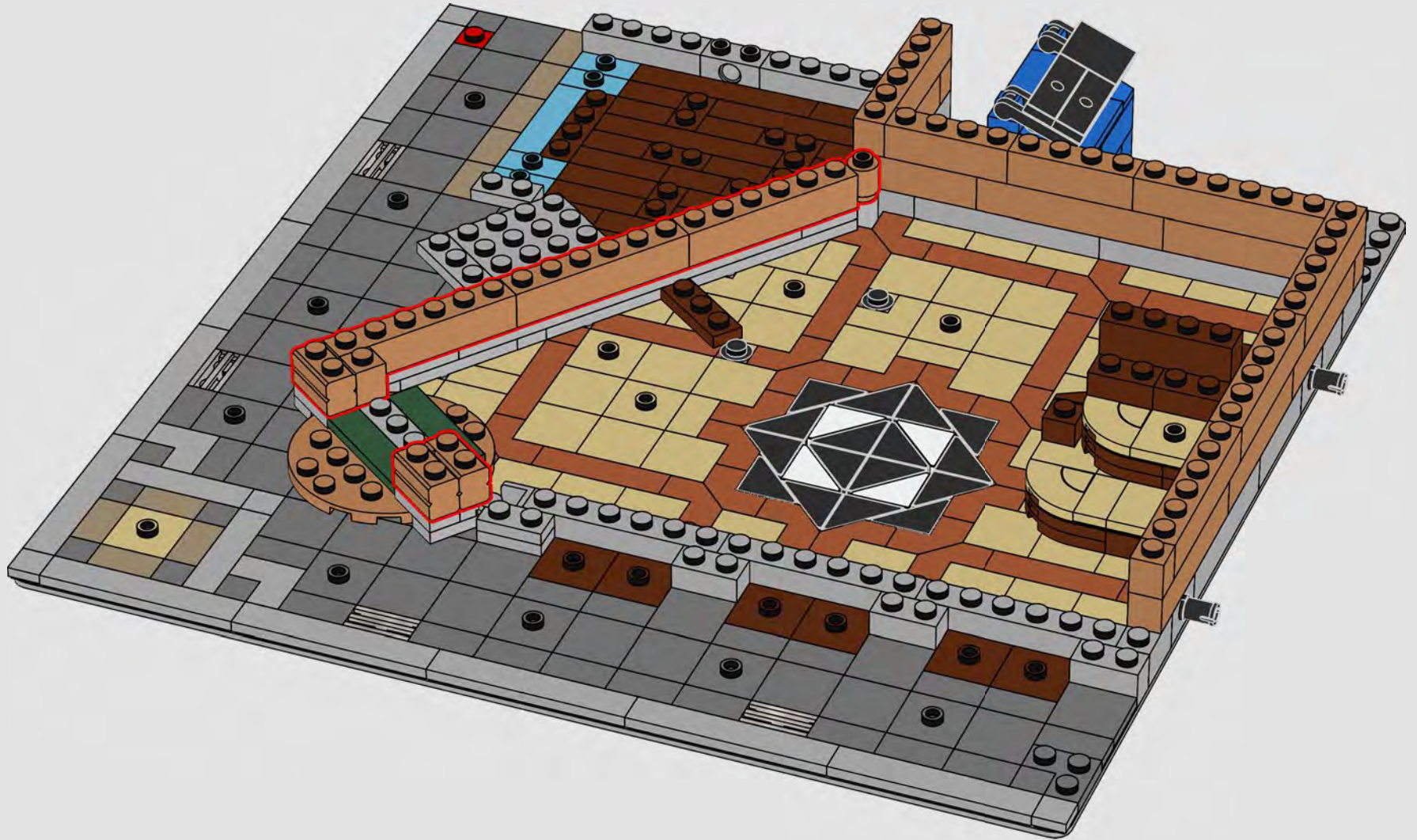

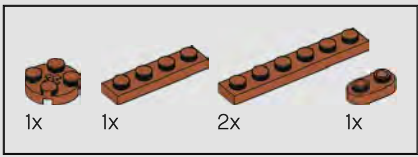

38

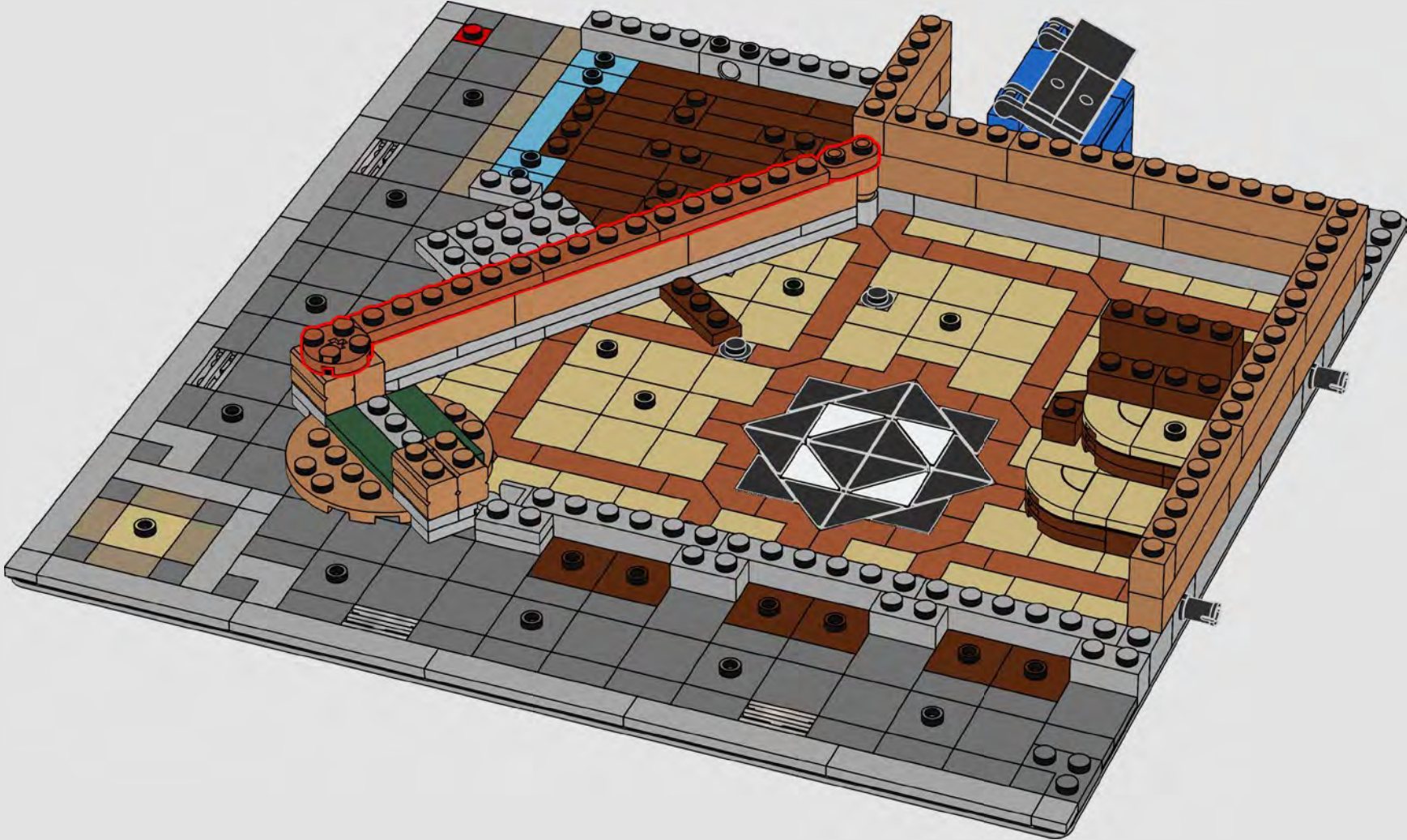

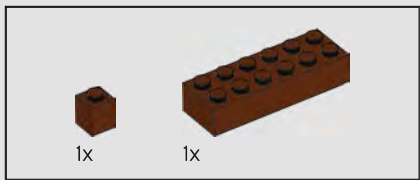

40

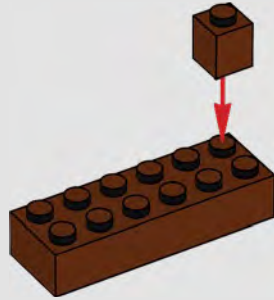

41

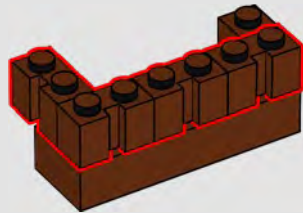

42

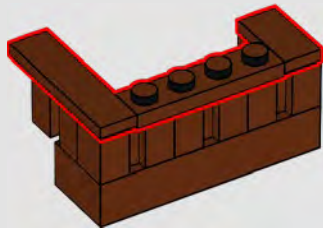

Many of the guests who've stayed in this hotel are residents of earlier Modular sets!
Can you identify them?

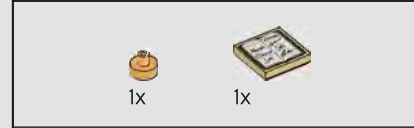

43

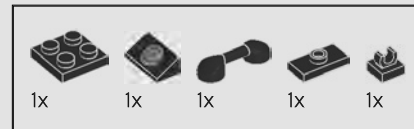

44

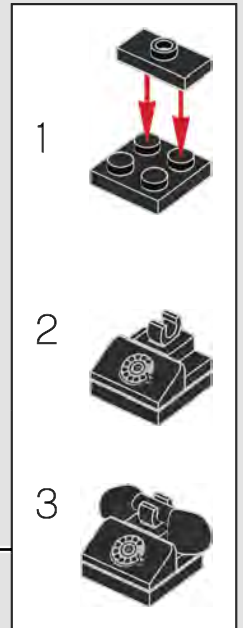
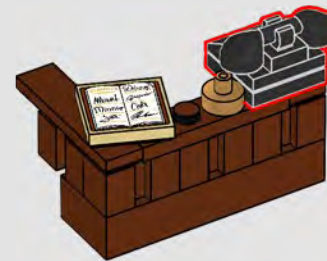



The Receptionist enjoys calling her friend the Lieutenant in the 10278 Police Station set on this phone.

45

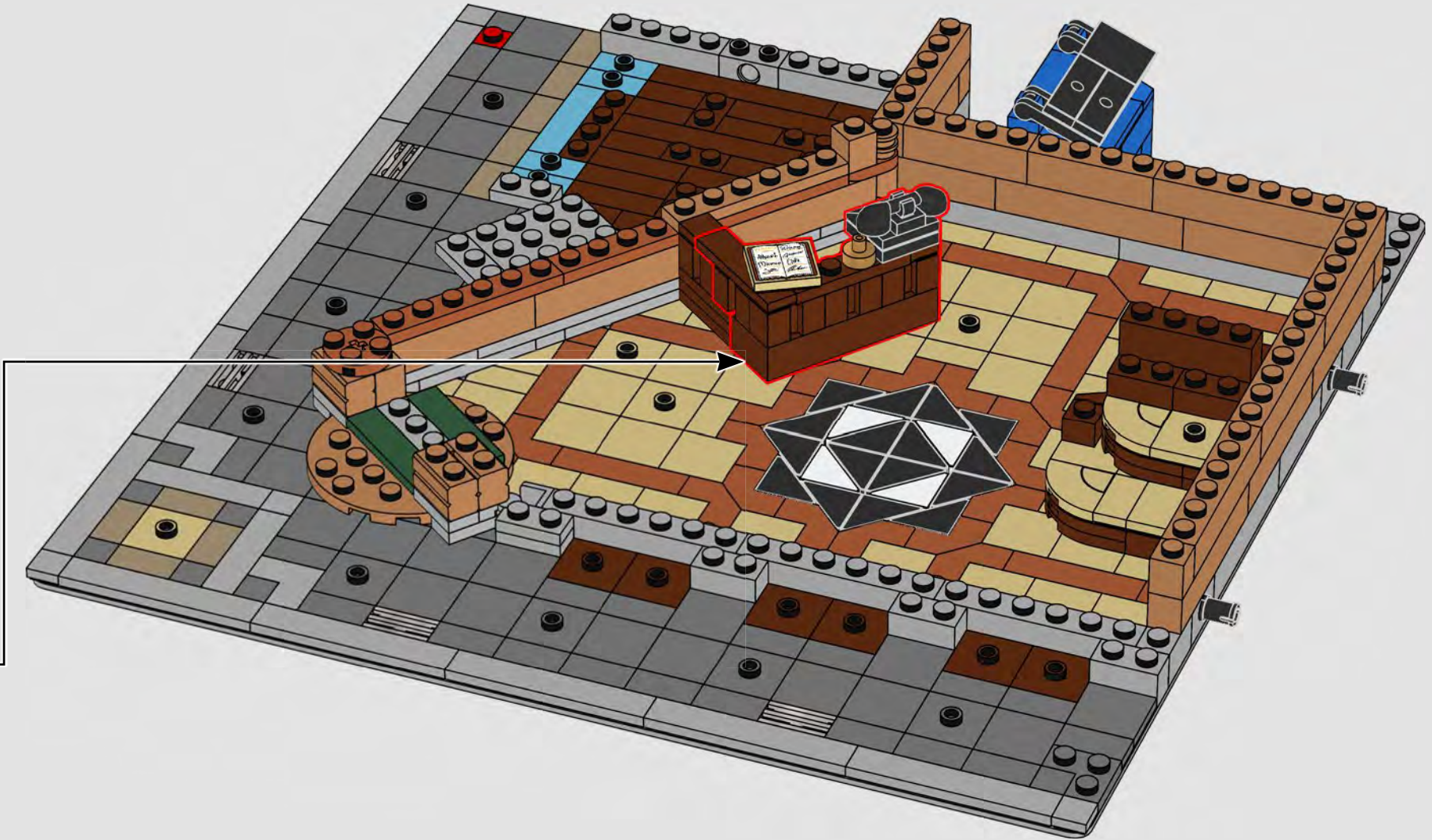

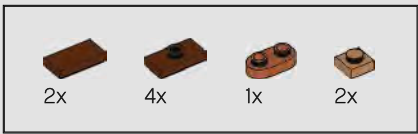

46

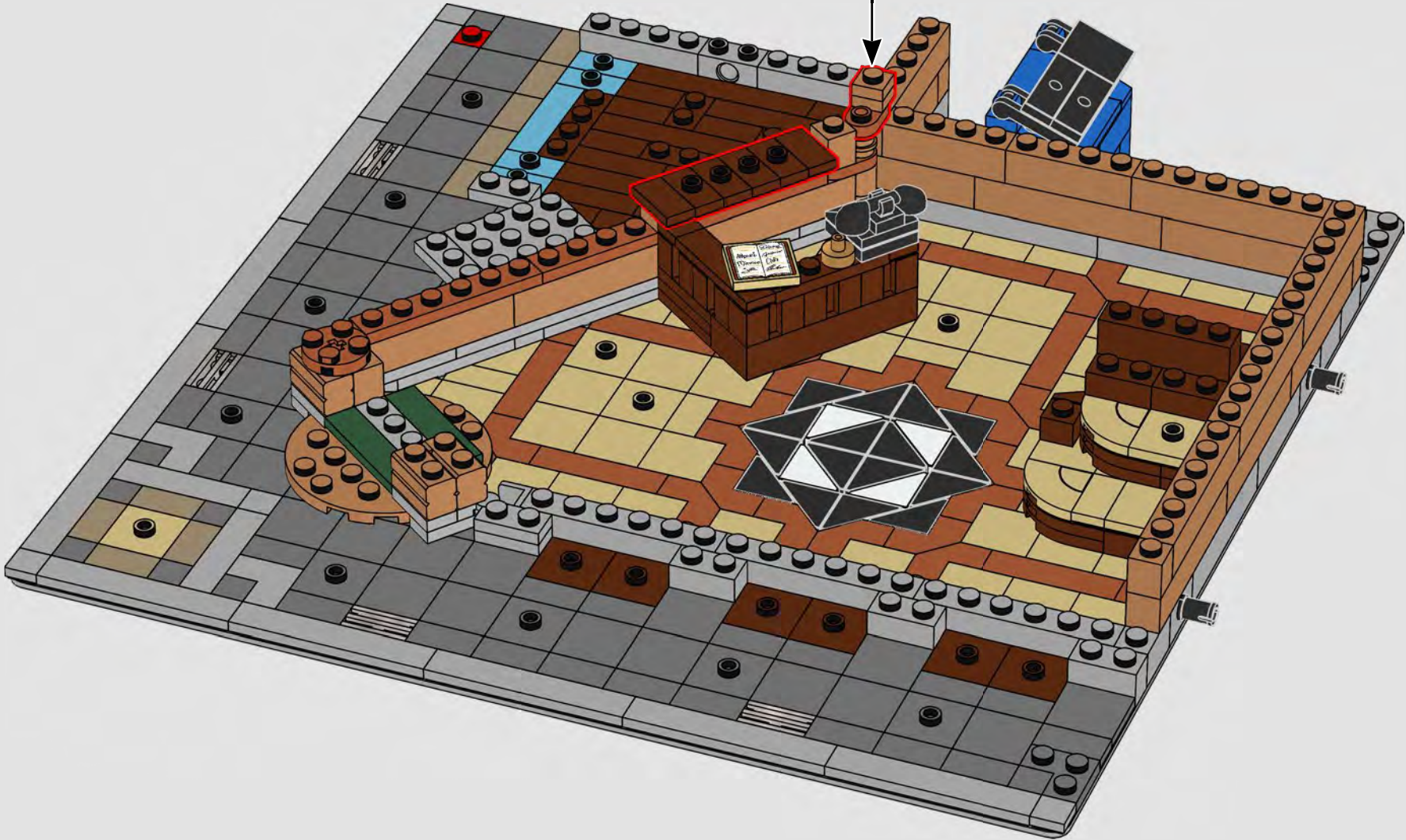
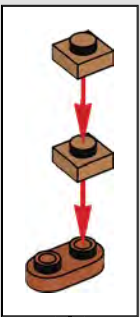

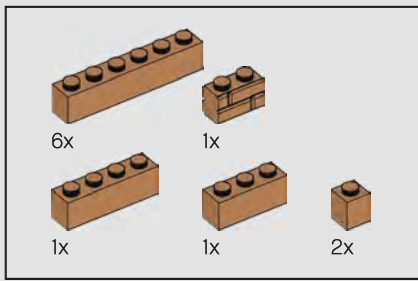

47

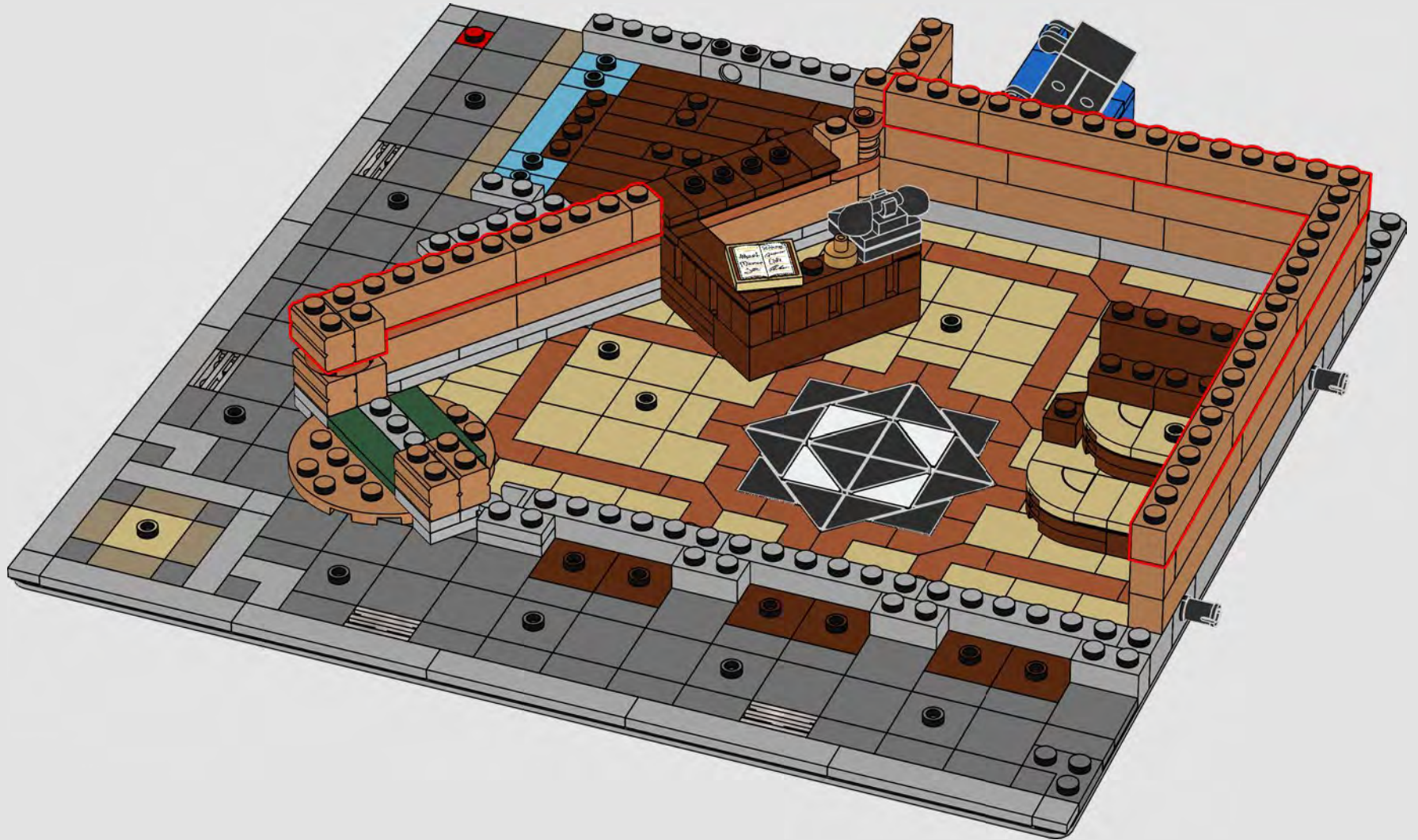

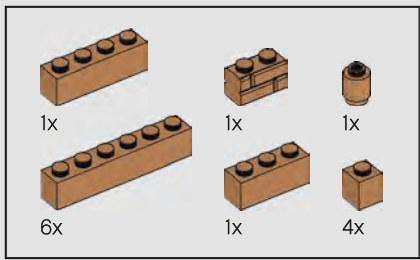

48

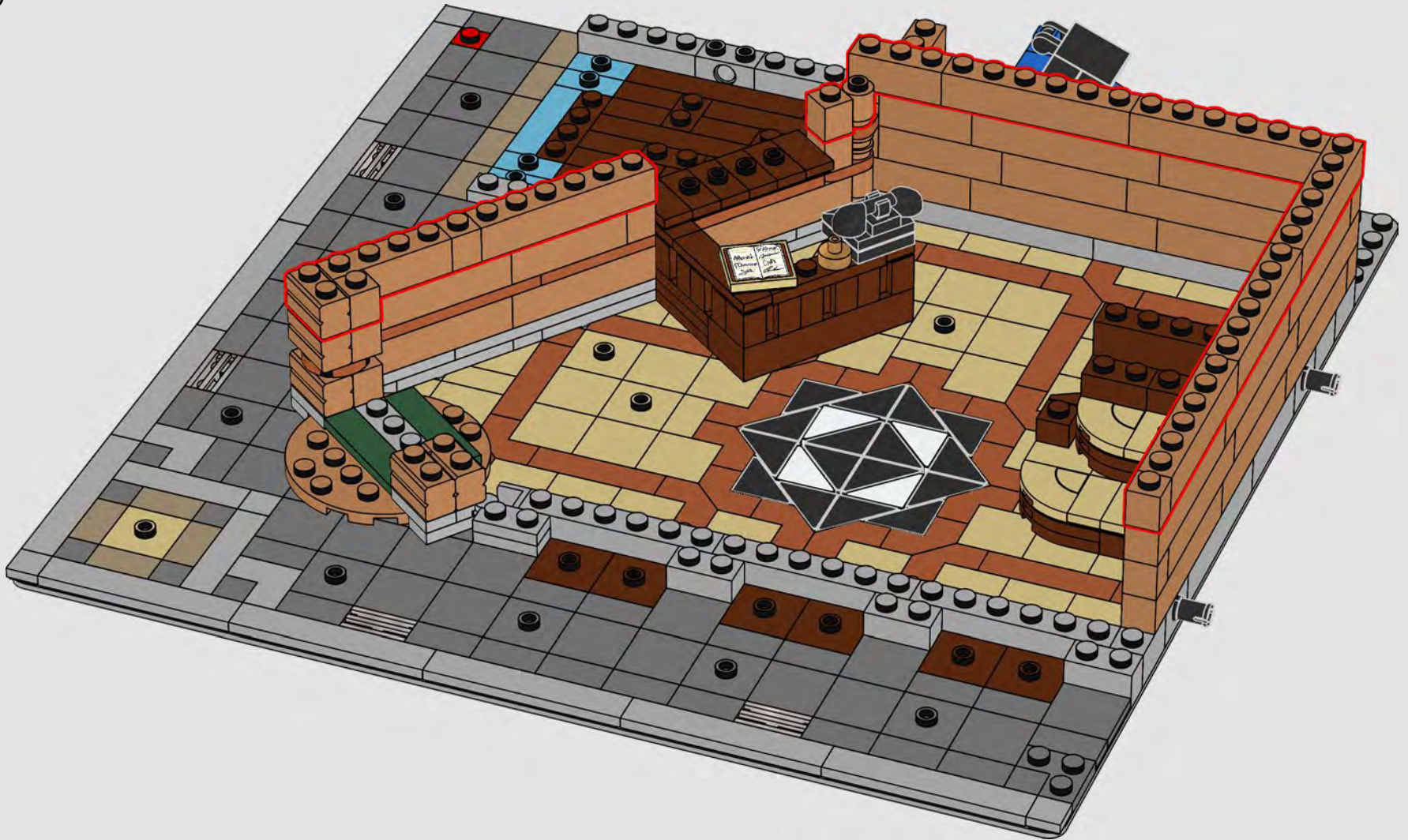

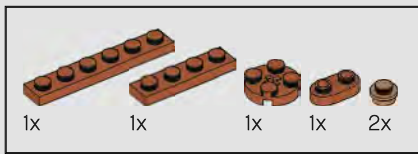

49

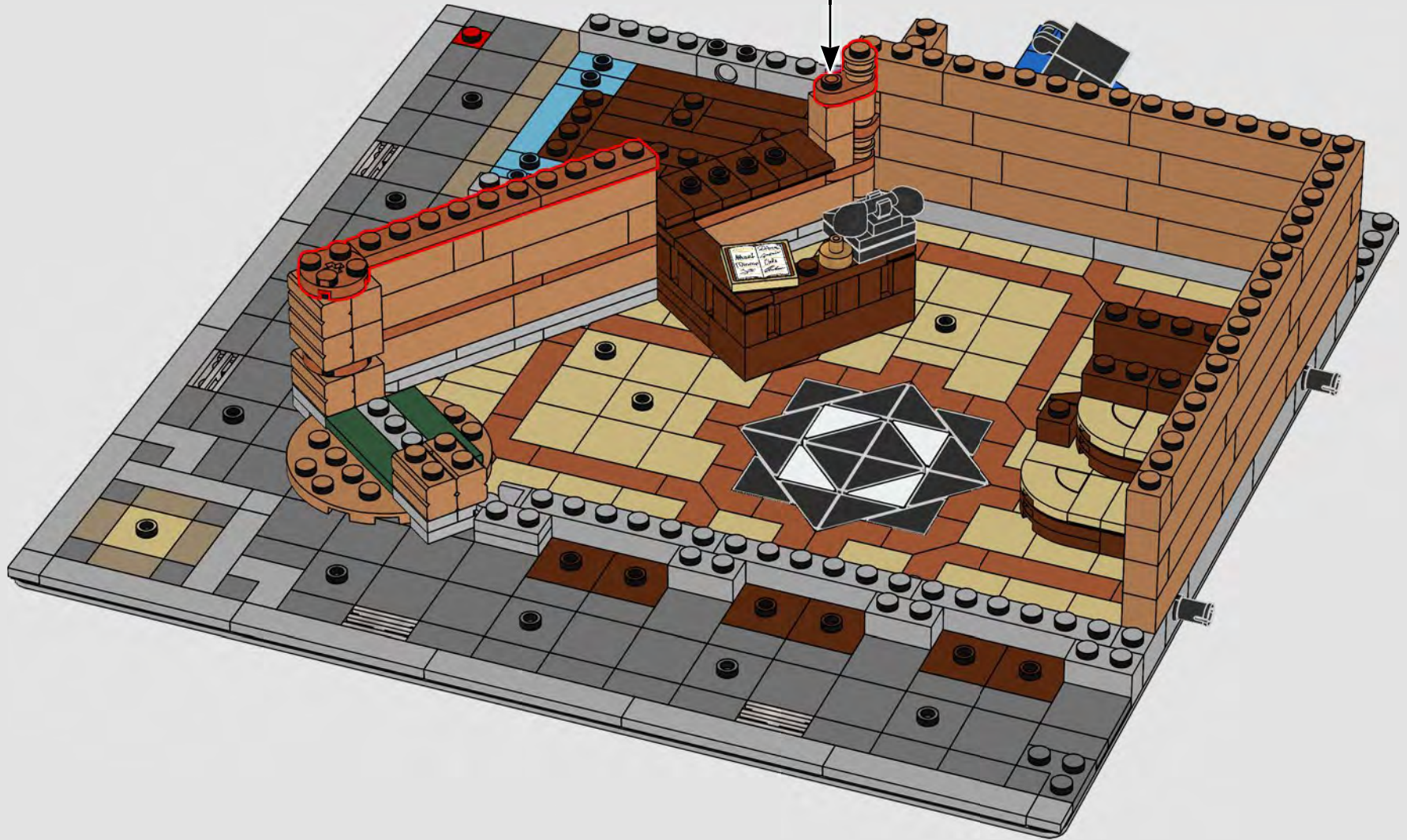
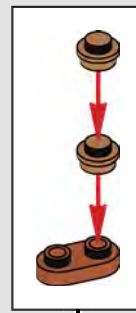

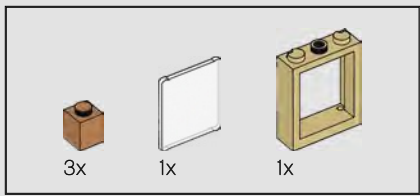

50

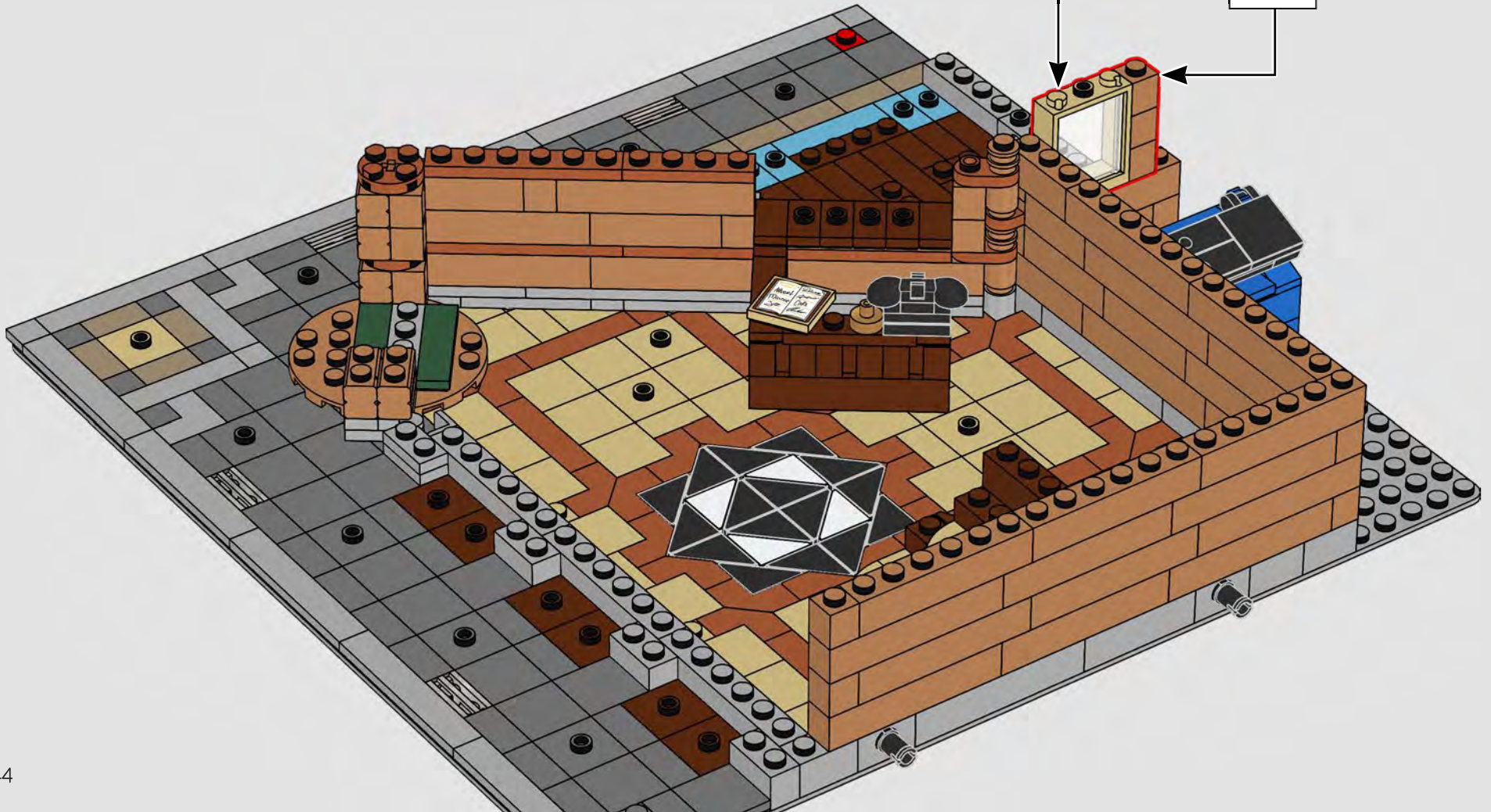
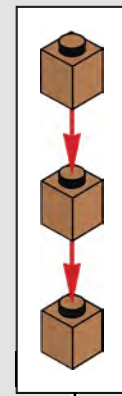
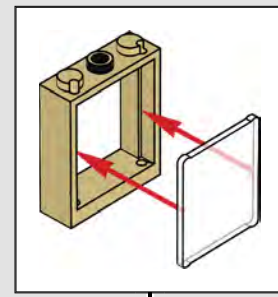

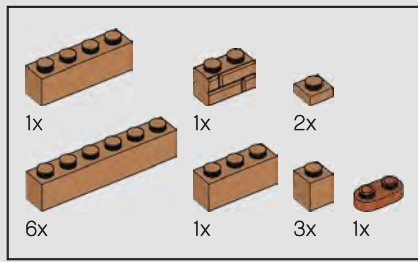

51

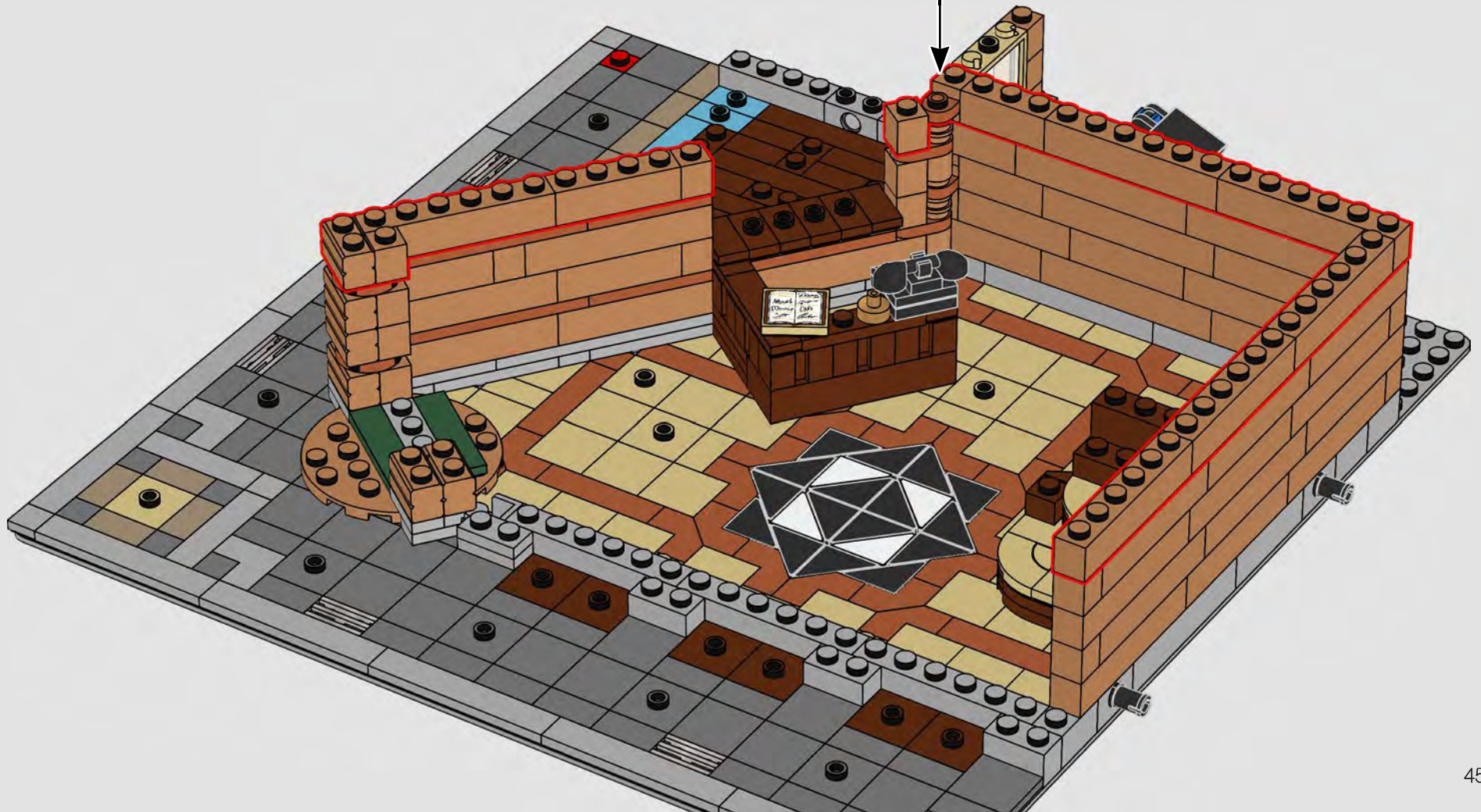
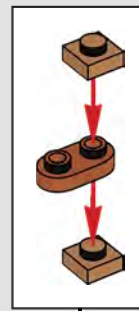

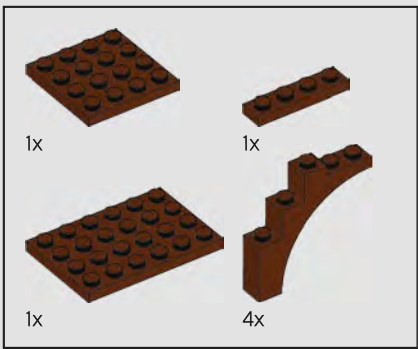

52

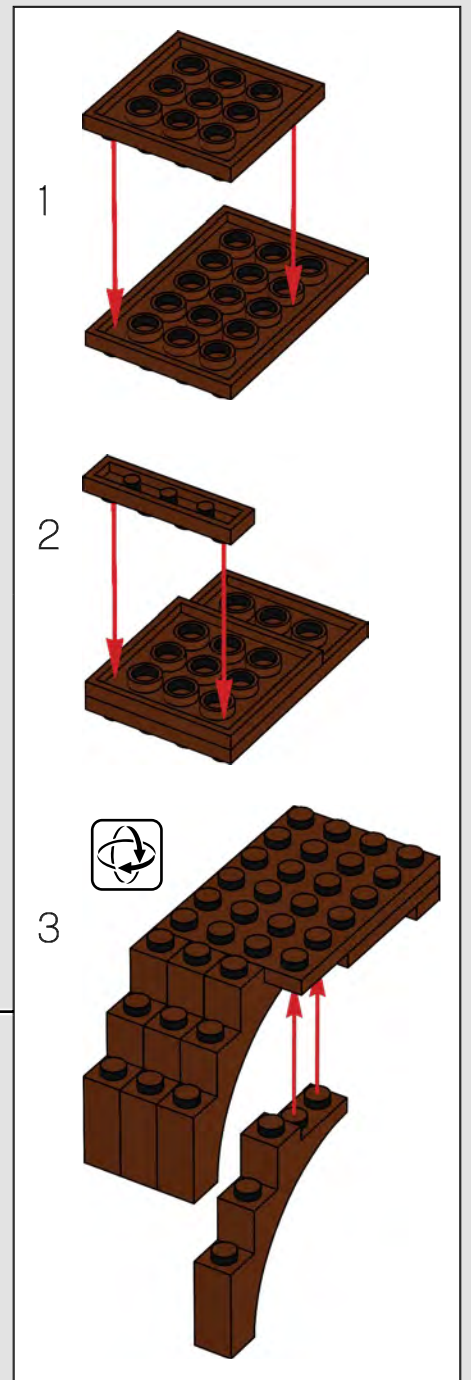
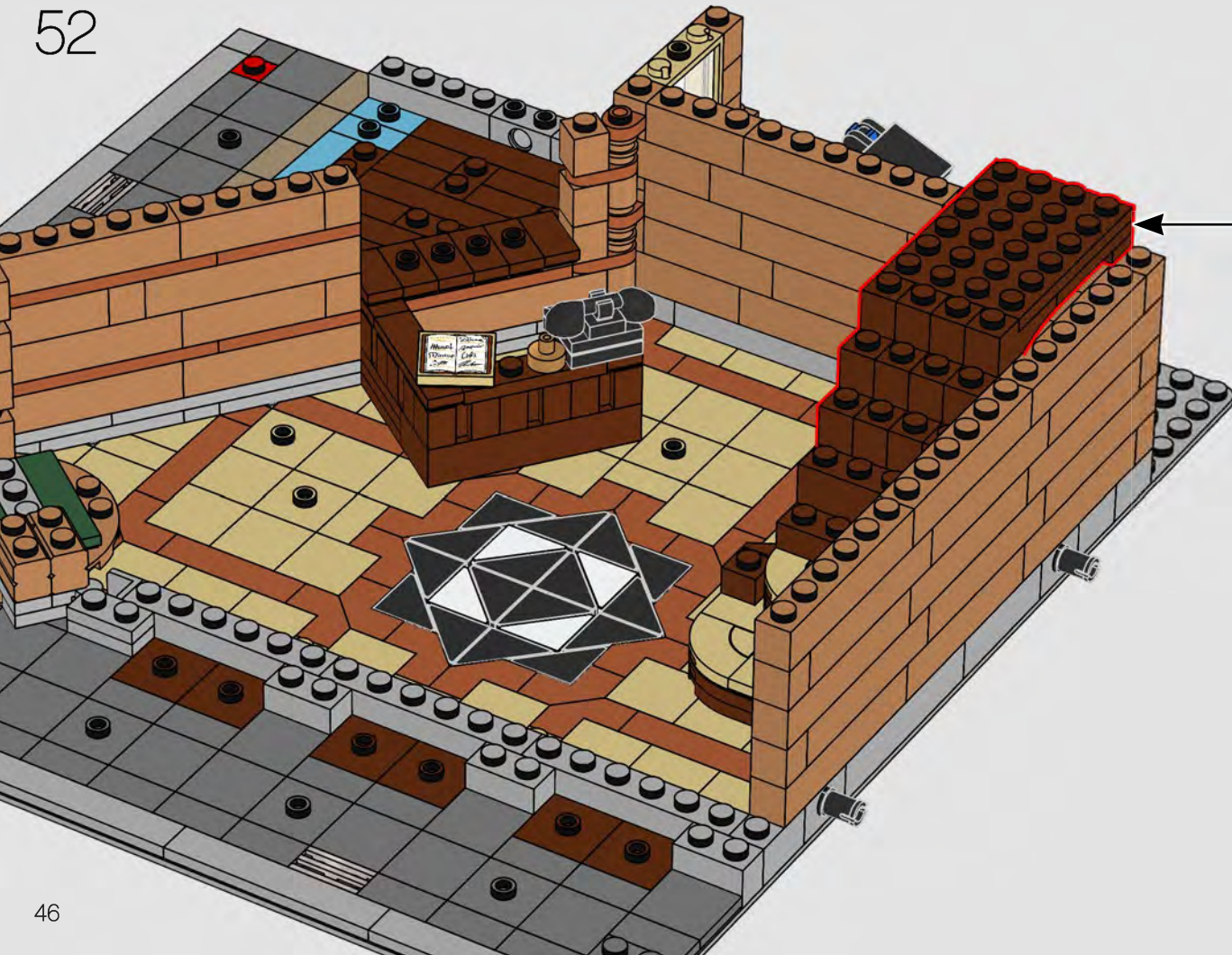



53

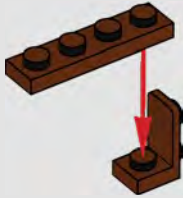

54

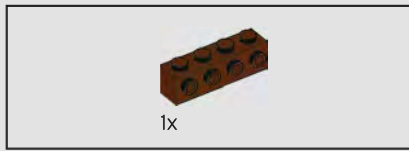
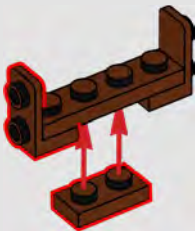

55

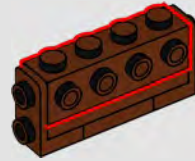

56

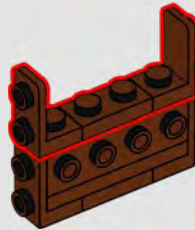

57

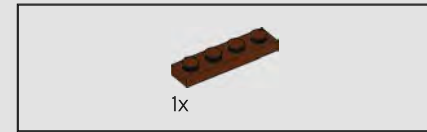

58

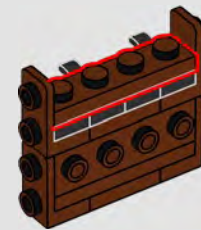



59



60



61

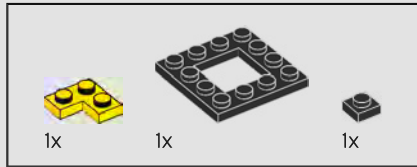
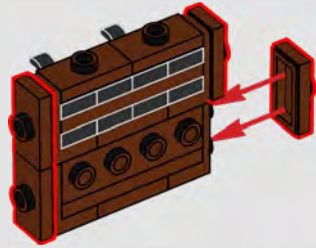

62

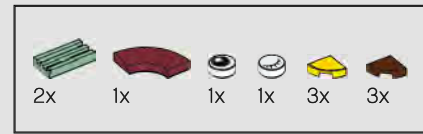
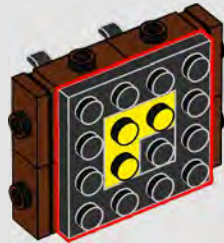

63



64

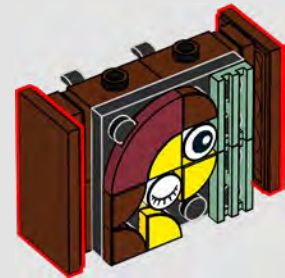



65



66

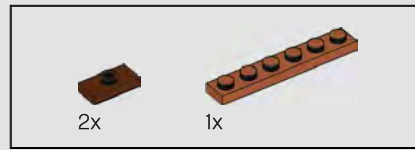
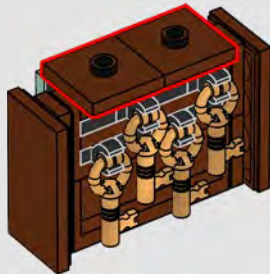

67

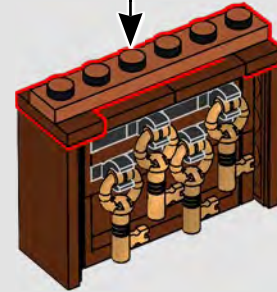
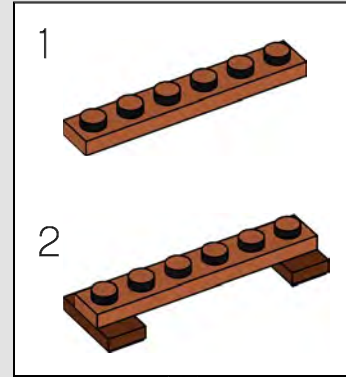

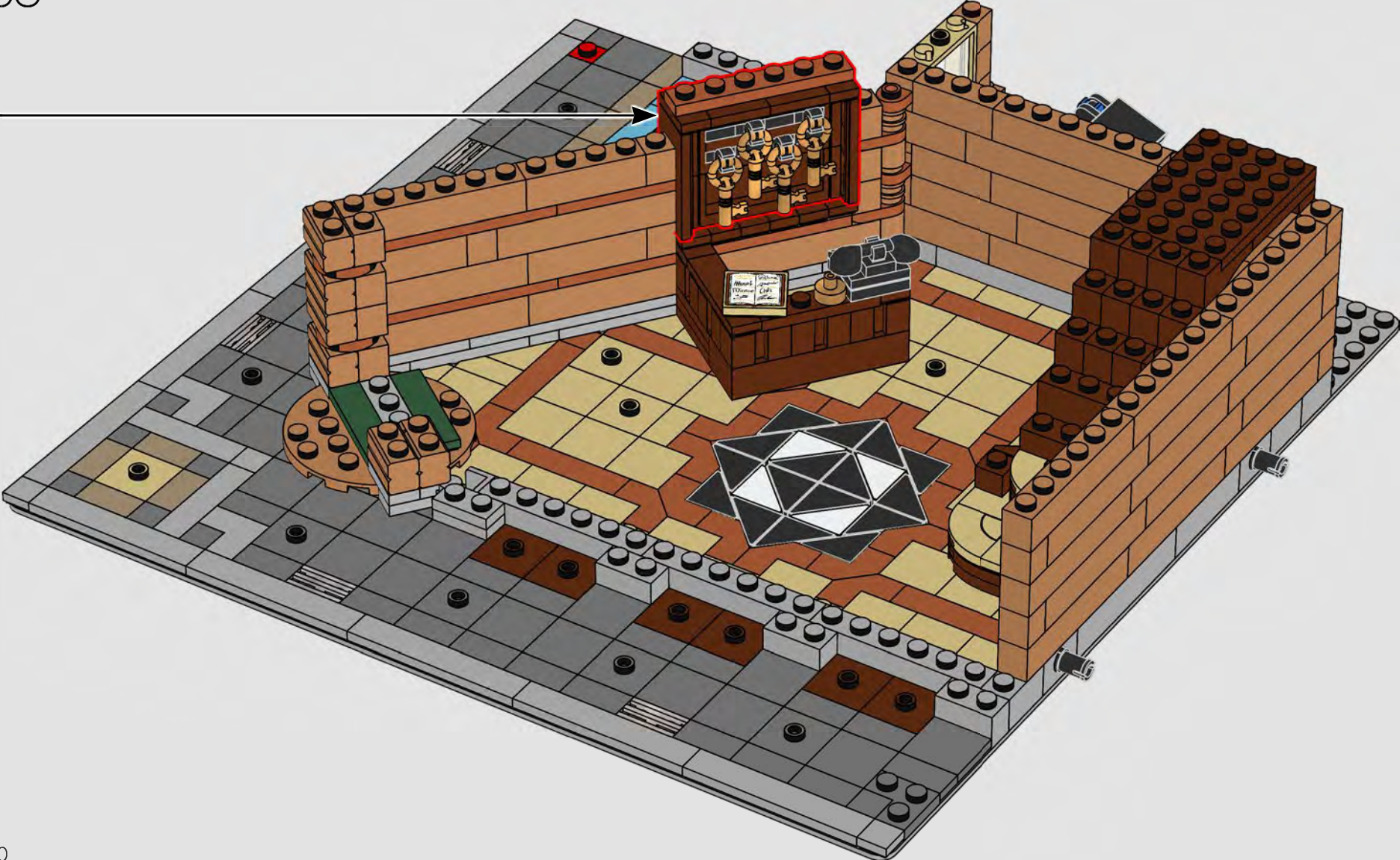

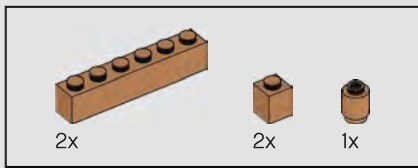

69

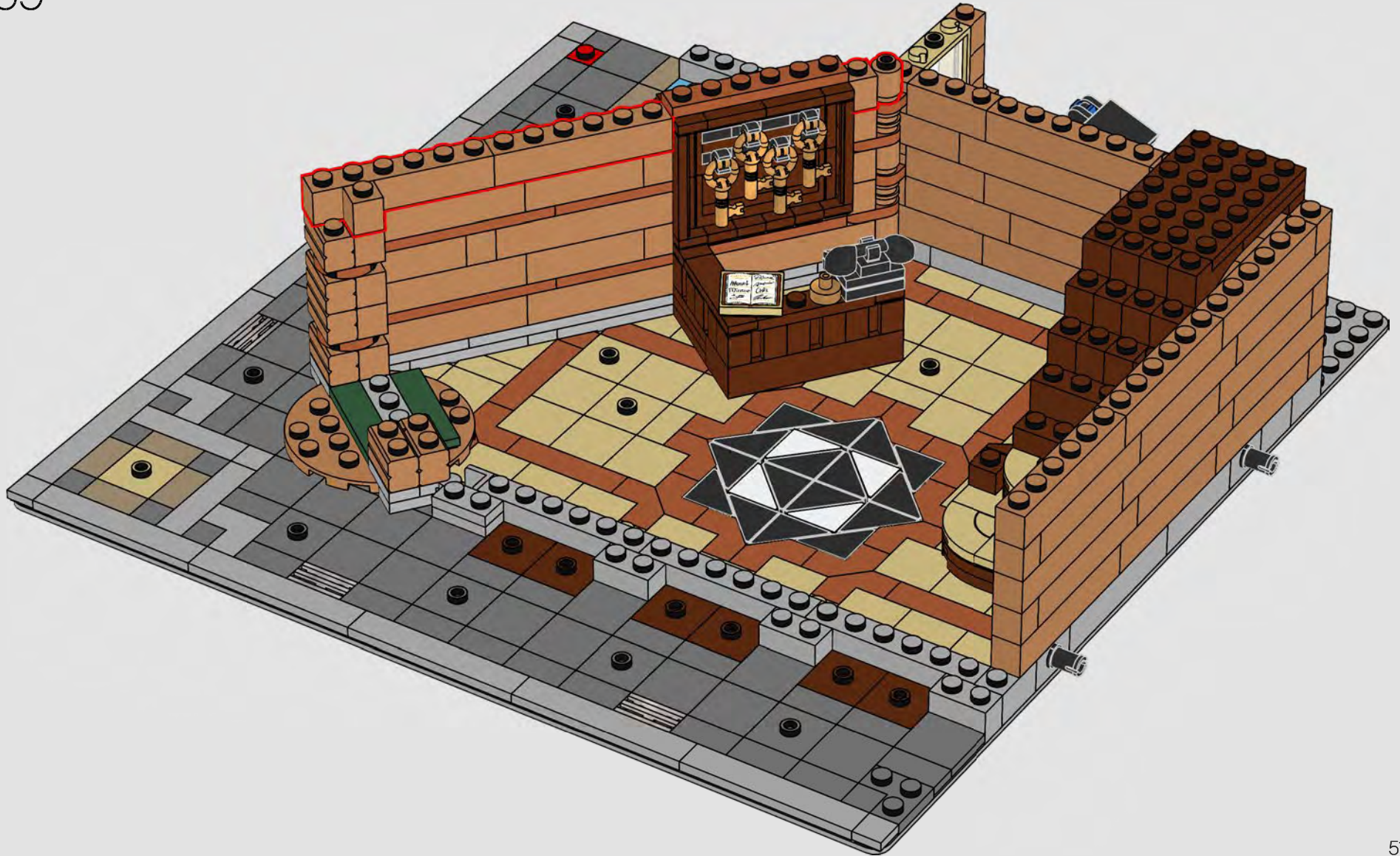



70





71

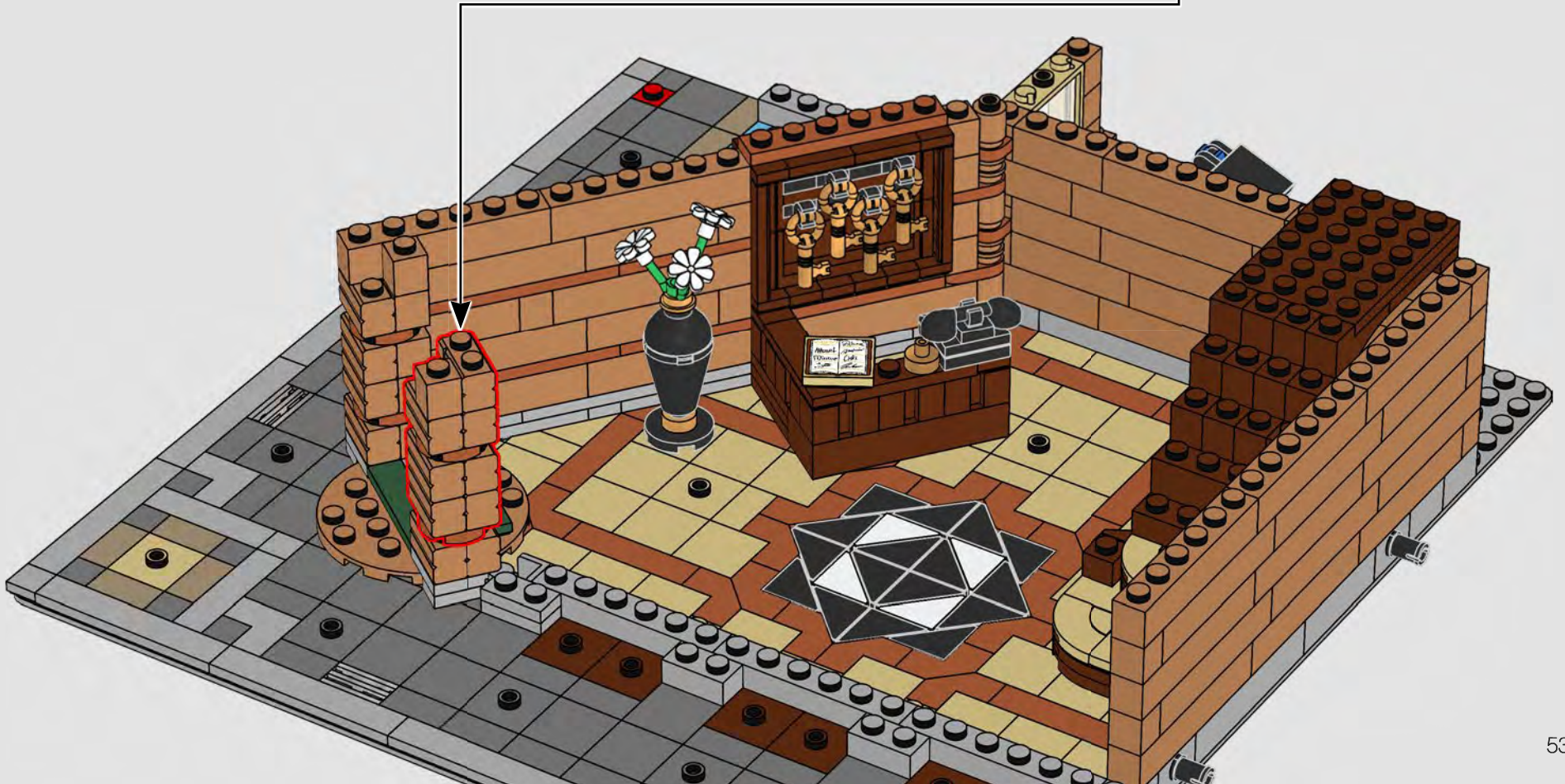
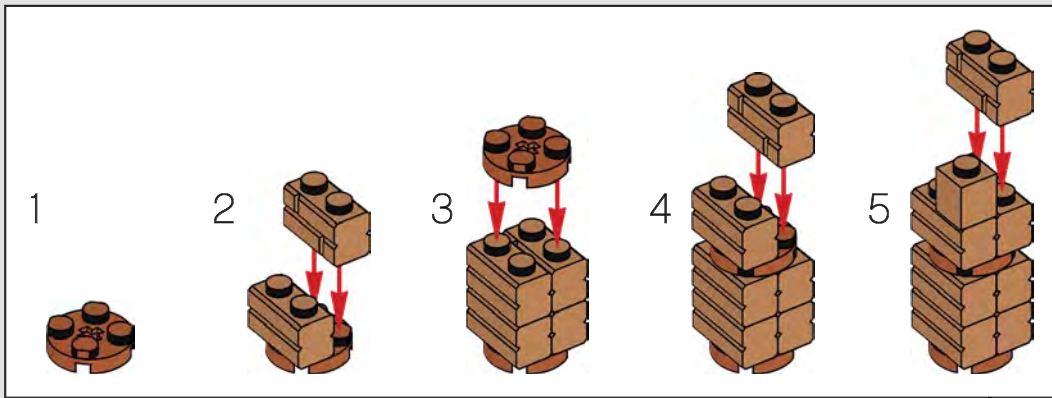

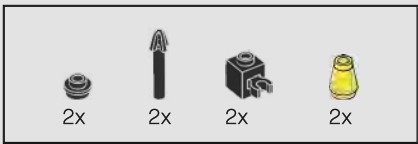

72

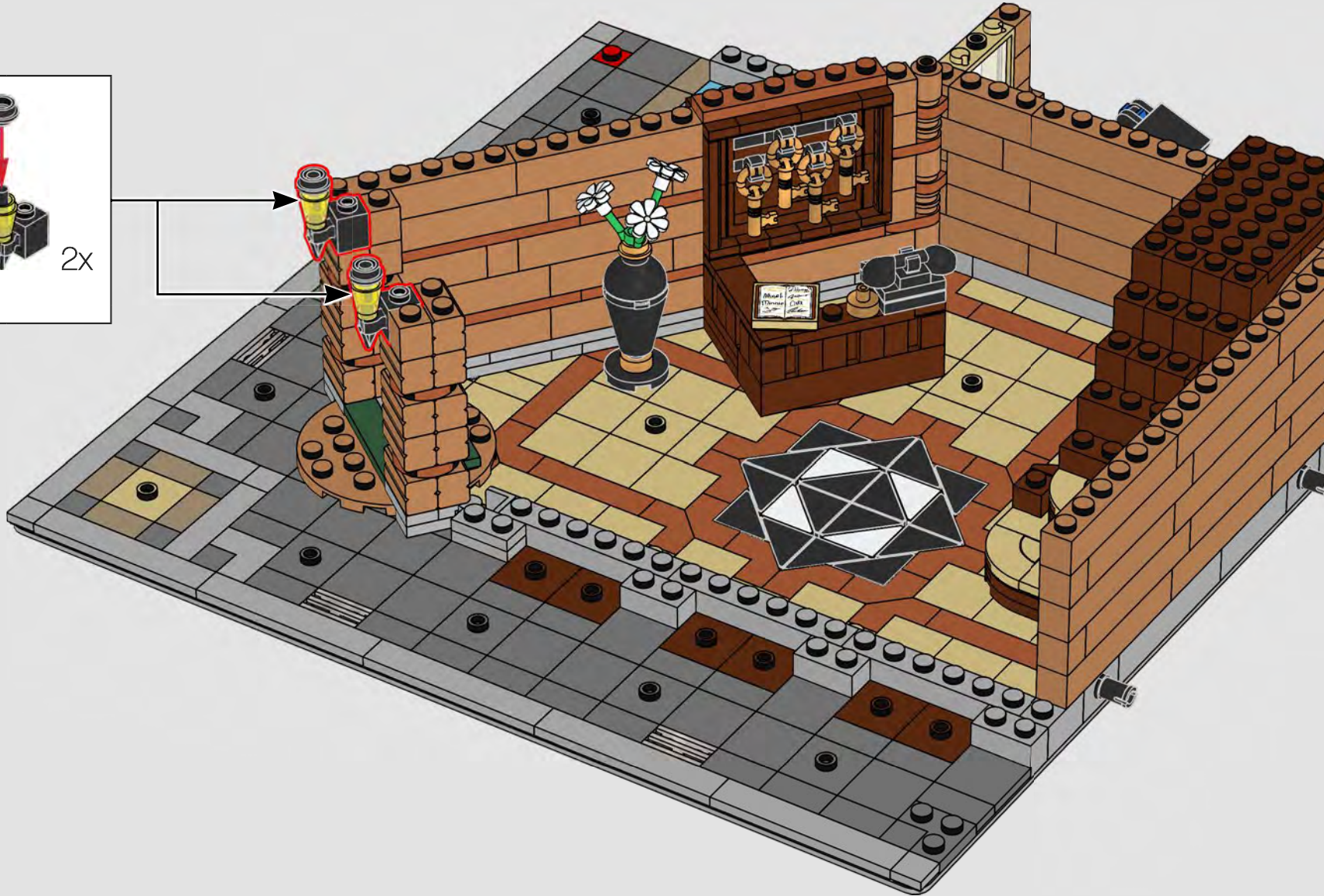
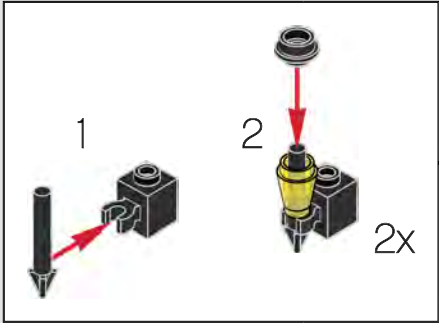

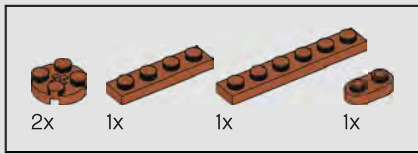

73

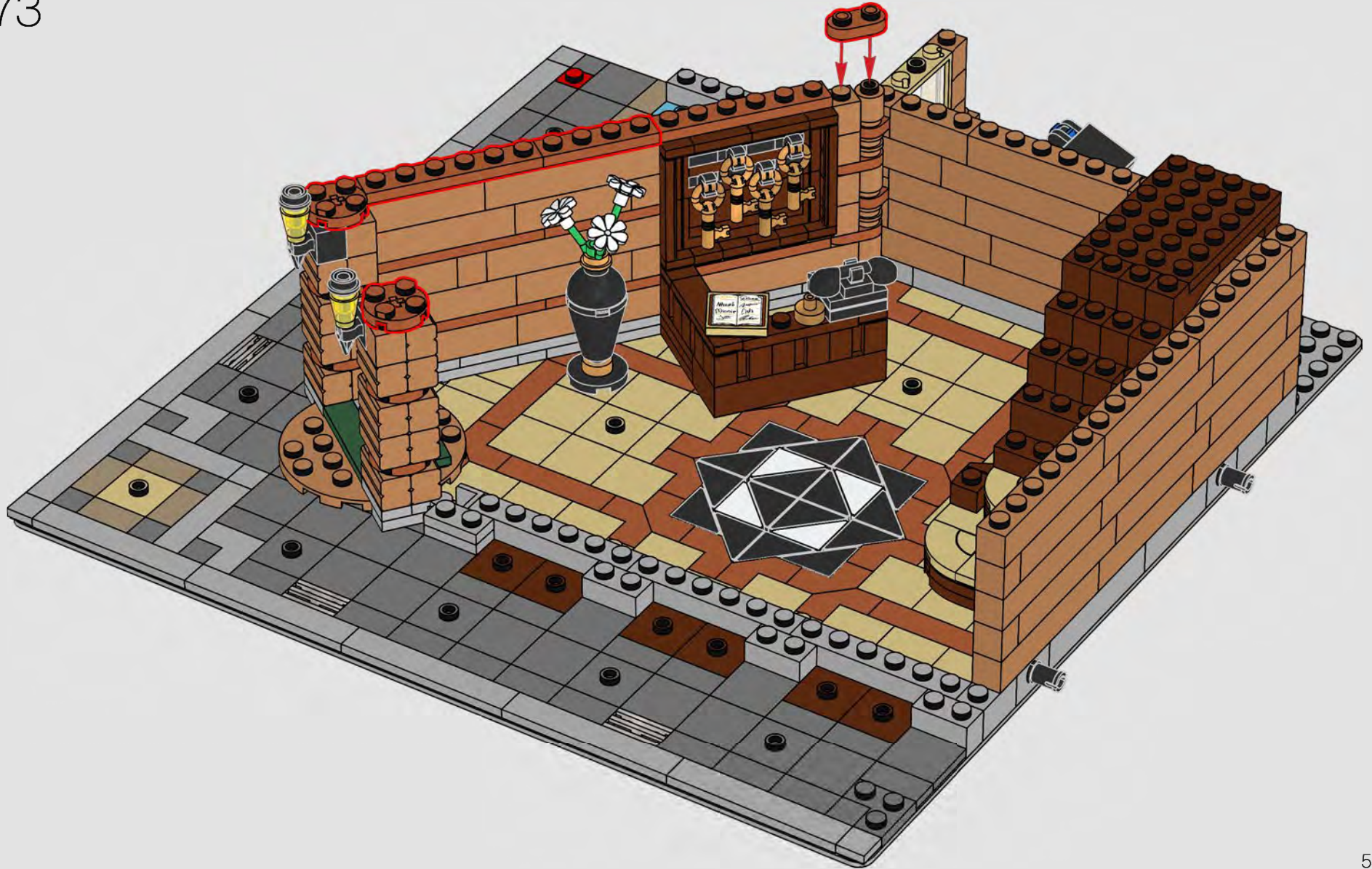

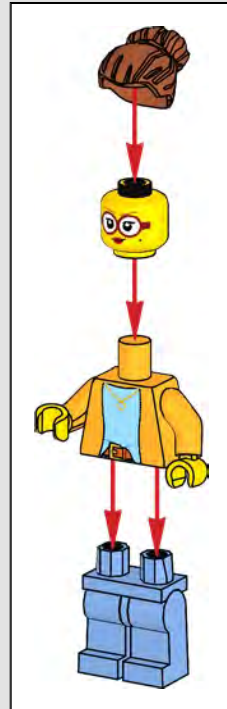
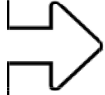

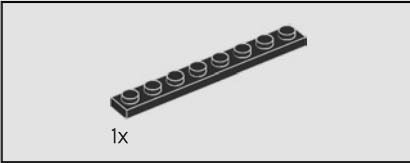

1x

74

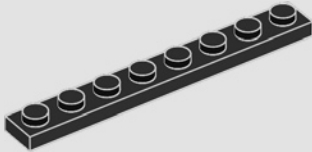

1x

75

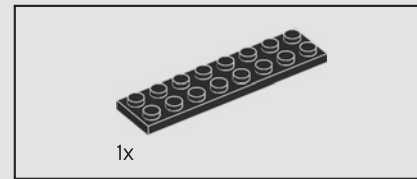
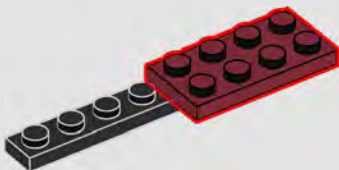

1x

76

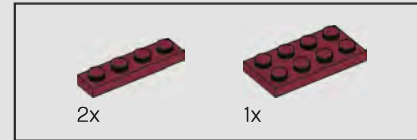
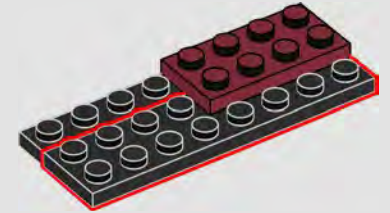

2x

1x

77

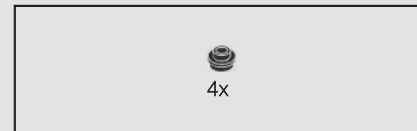

4x

78

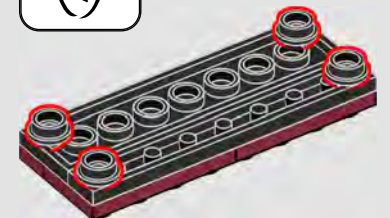
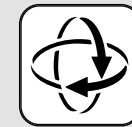



79

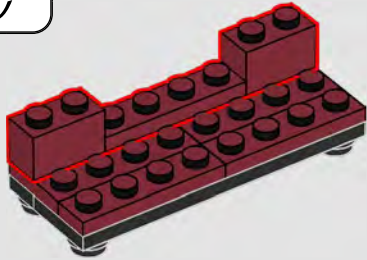

80

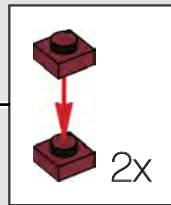
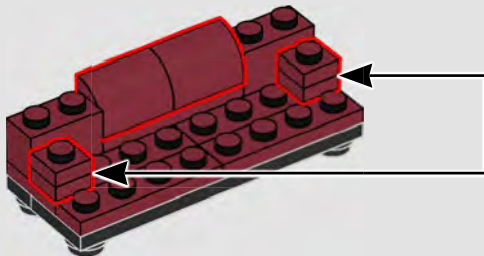

81

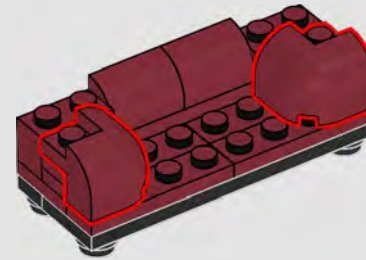

82





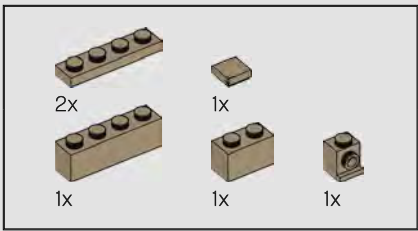

84

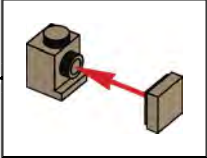
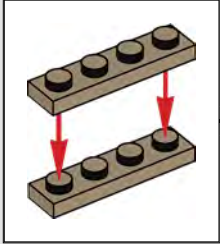
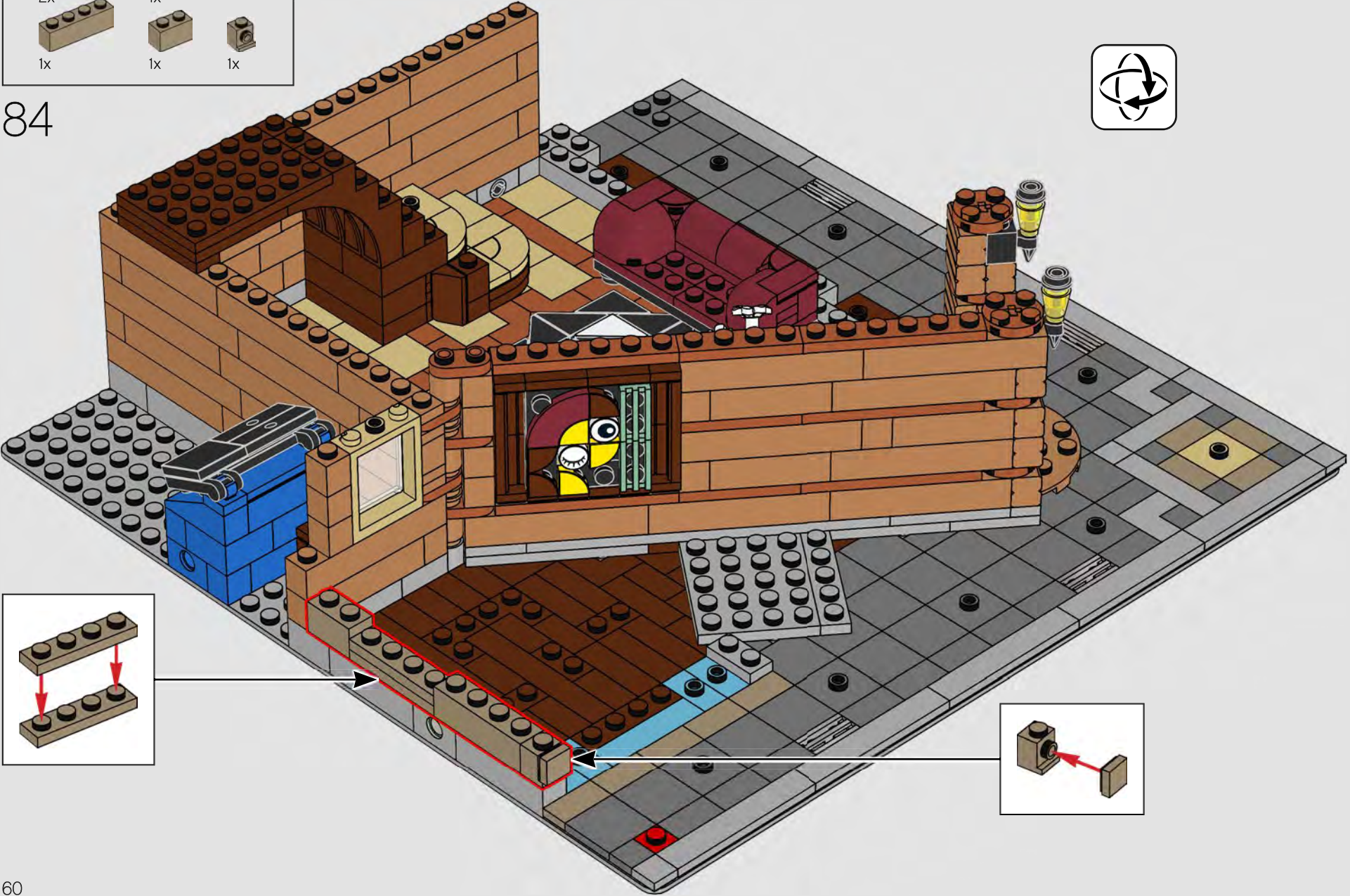

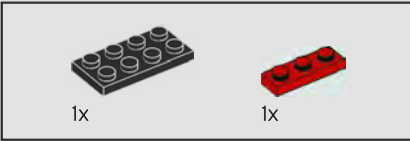

85



86



87

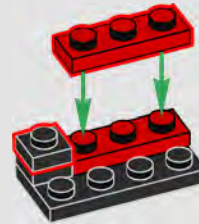

88

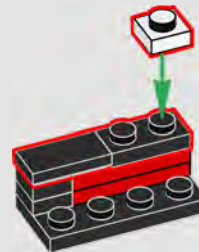

89



90

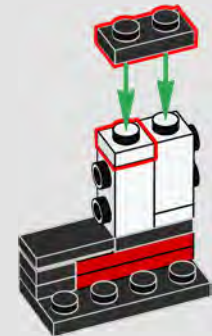



91

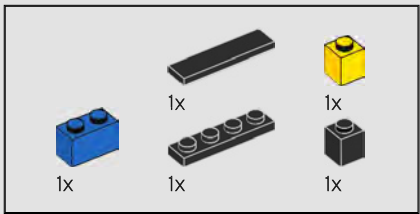

92

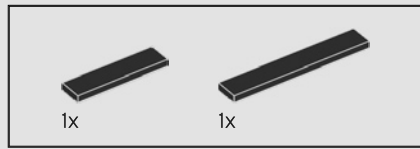
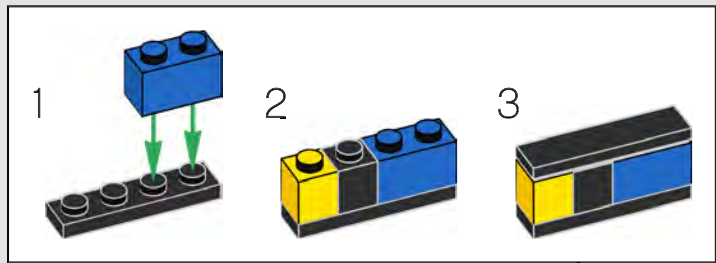

93



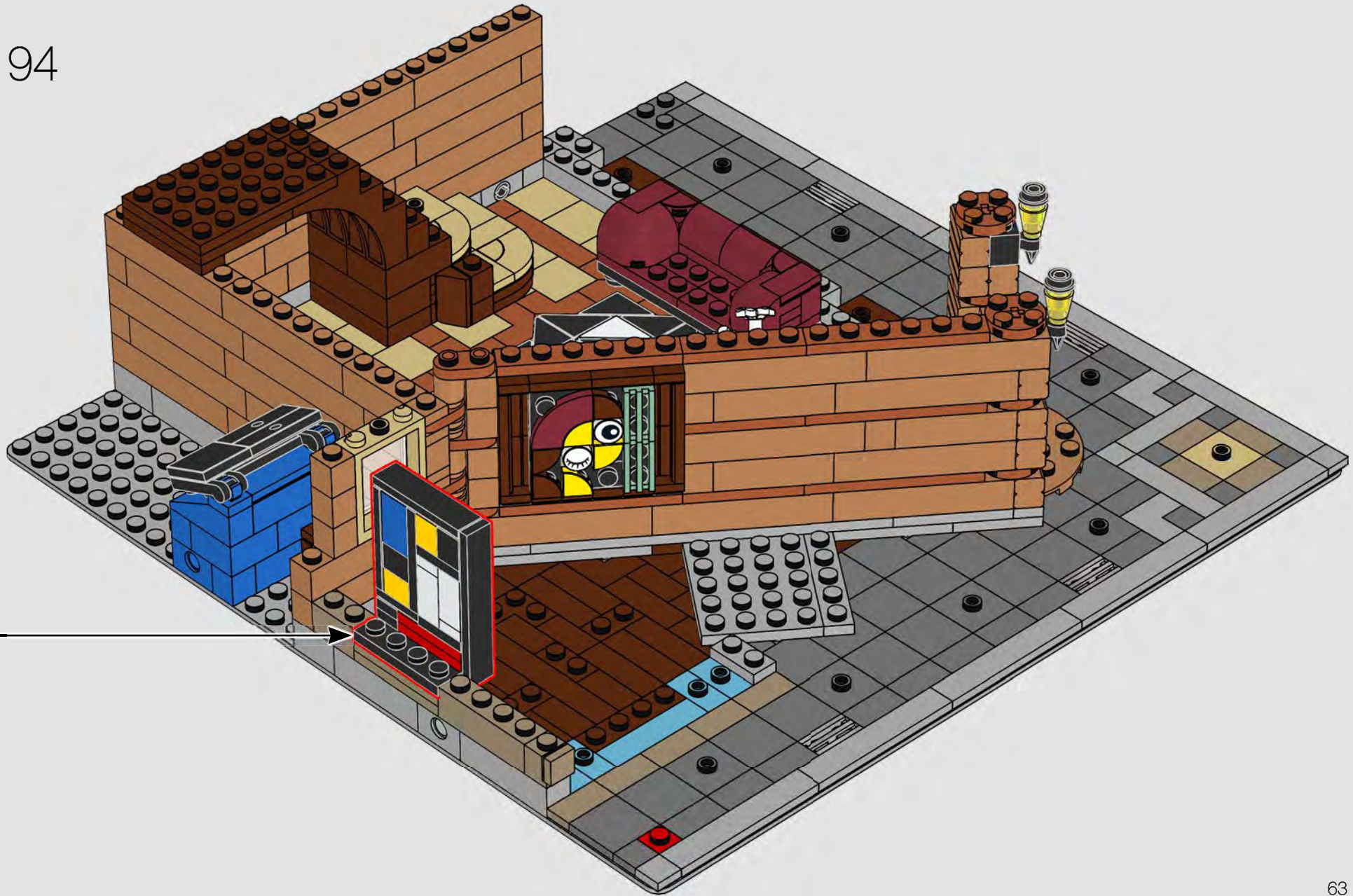

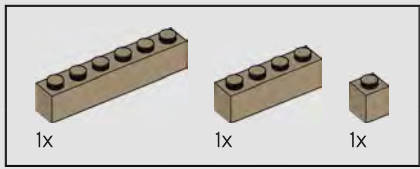

95

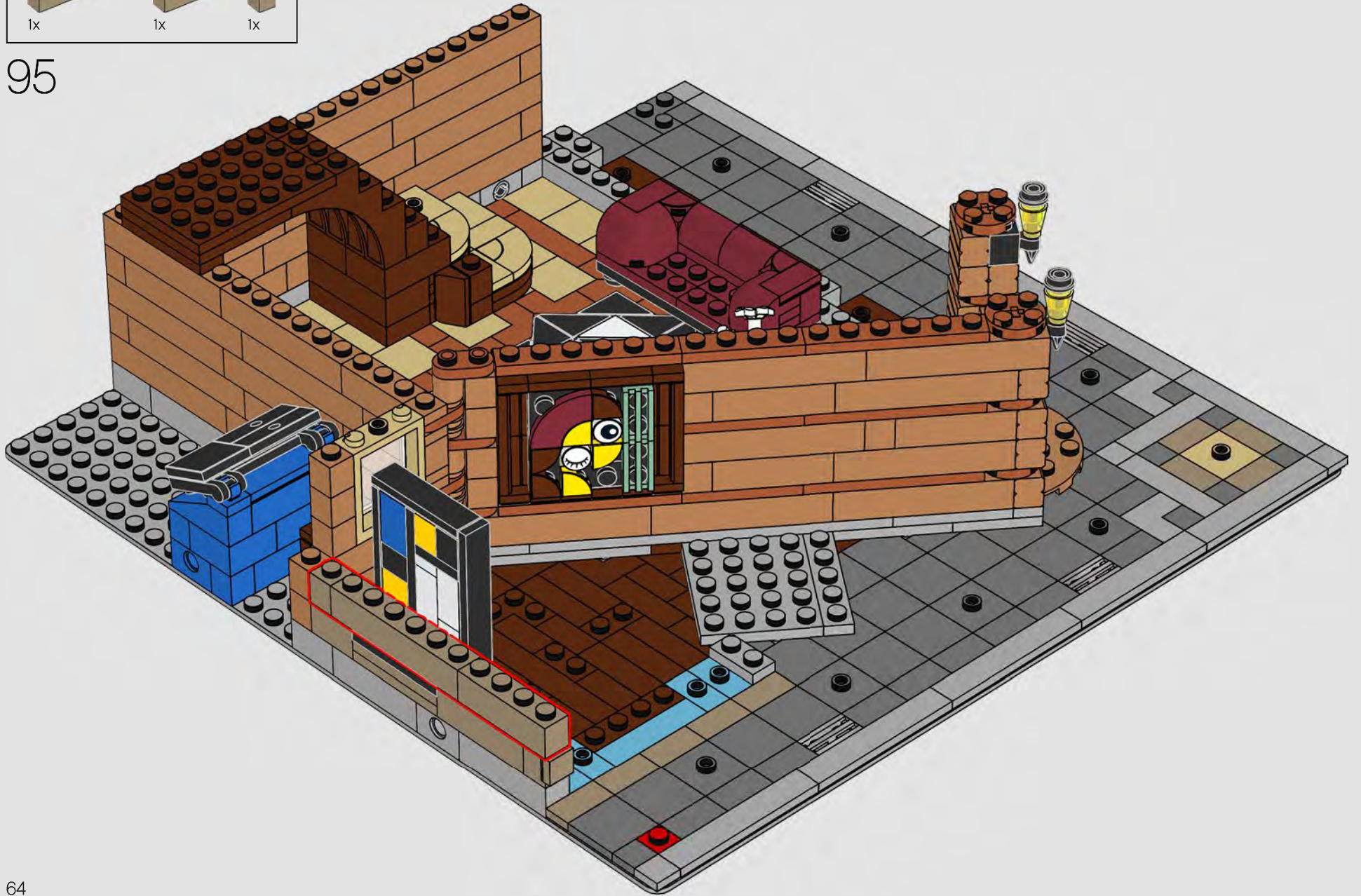

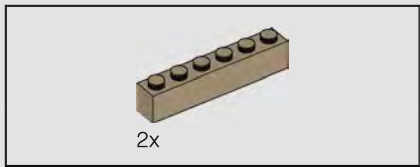

97

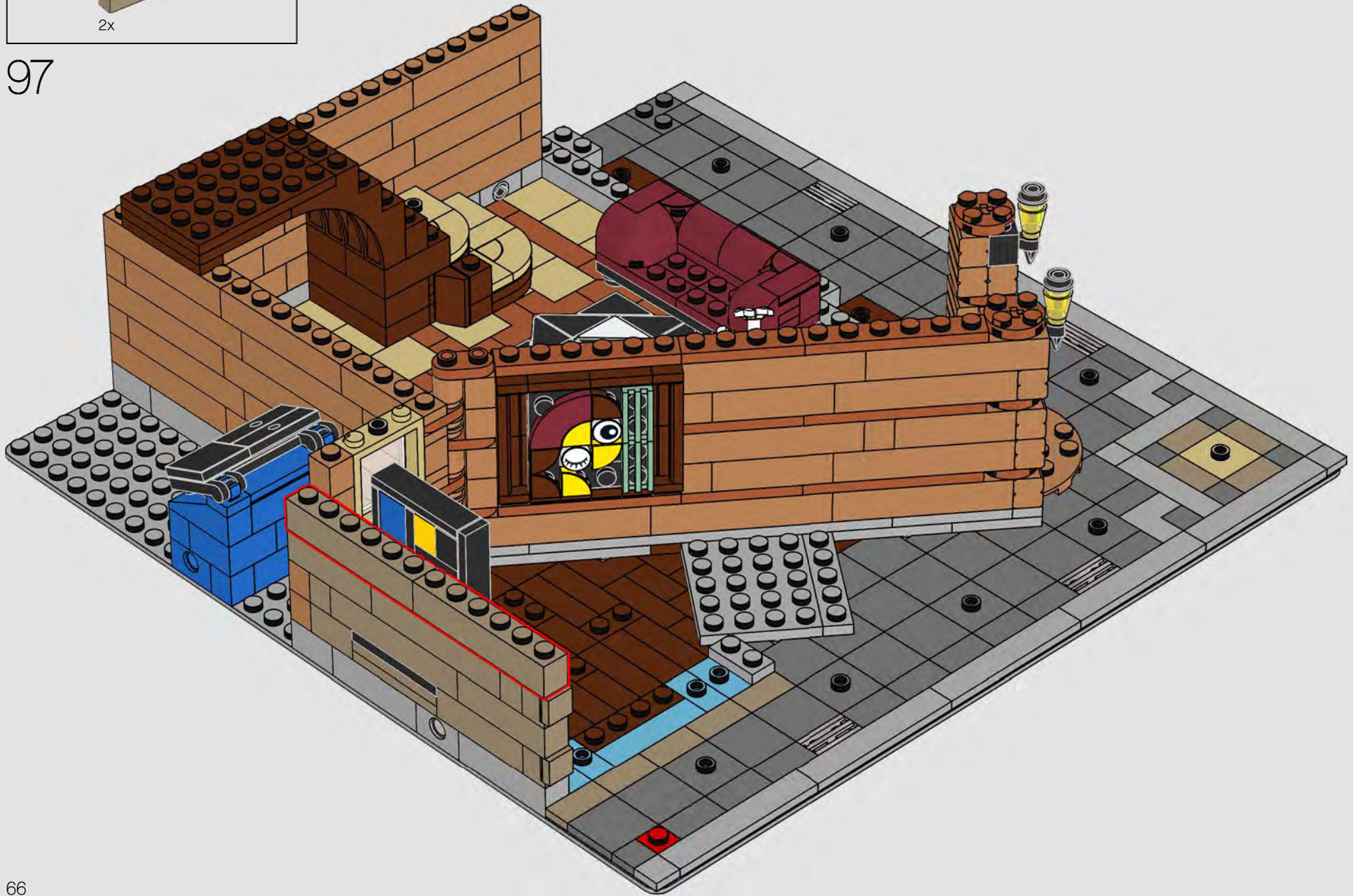

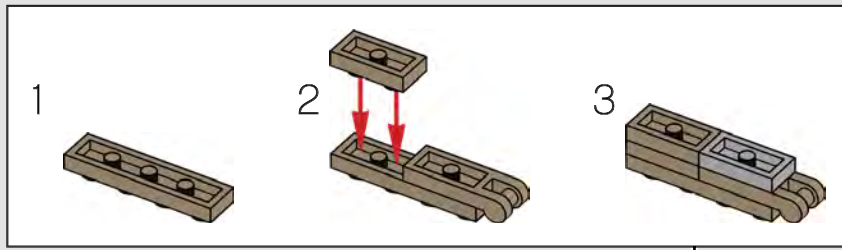
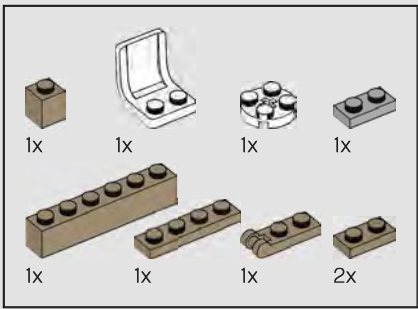

99



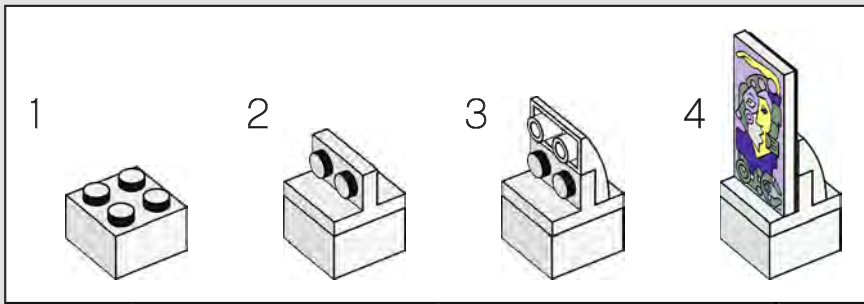
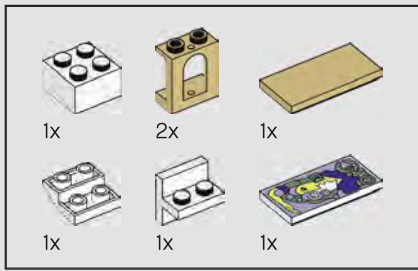

100

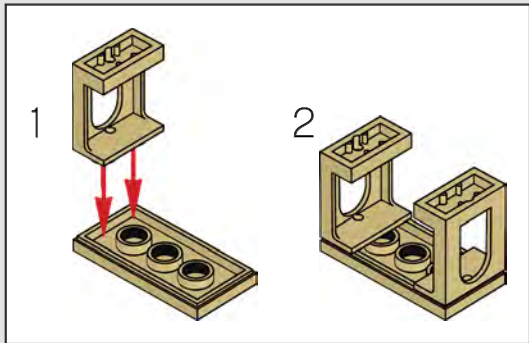

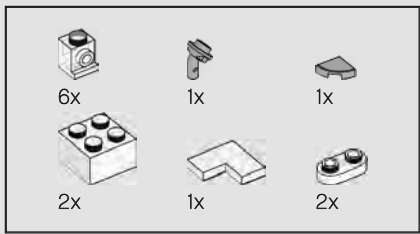

101

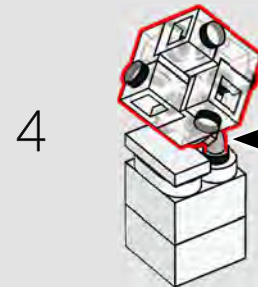
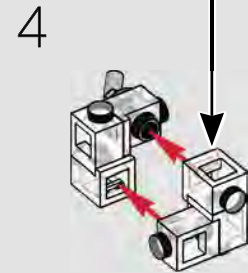
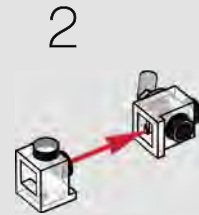
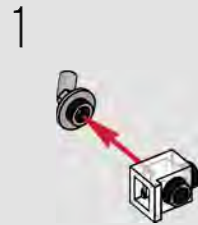
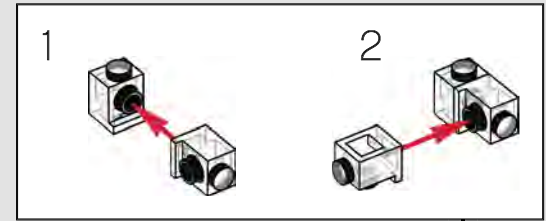
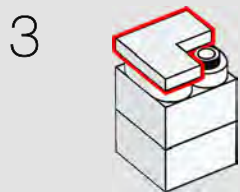
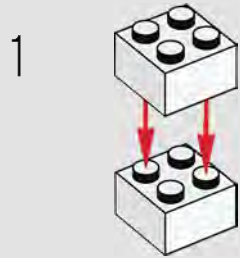

The Gallery Owner is very excited to debut her collection of Cubist Art! Her favourite piece, though, isn't Cubist – it's just an expertly made cube.

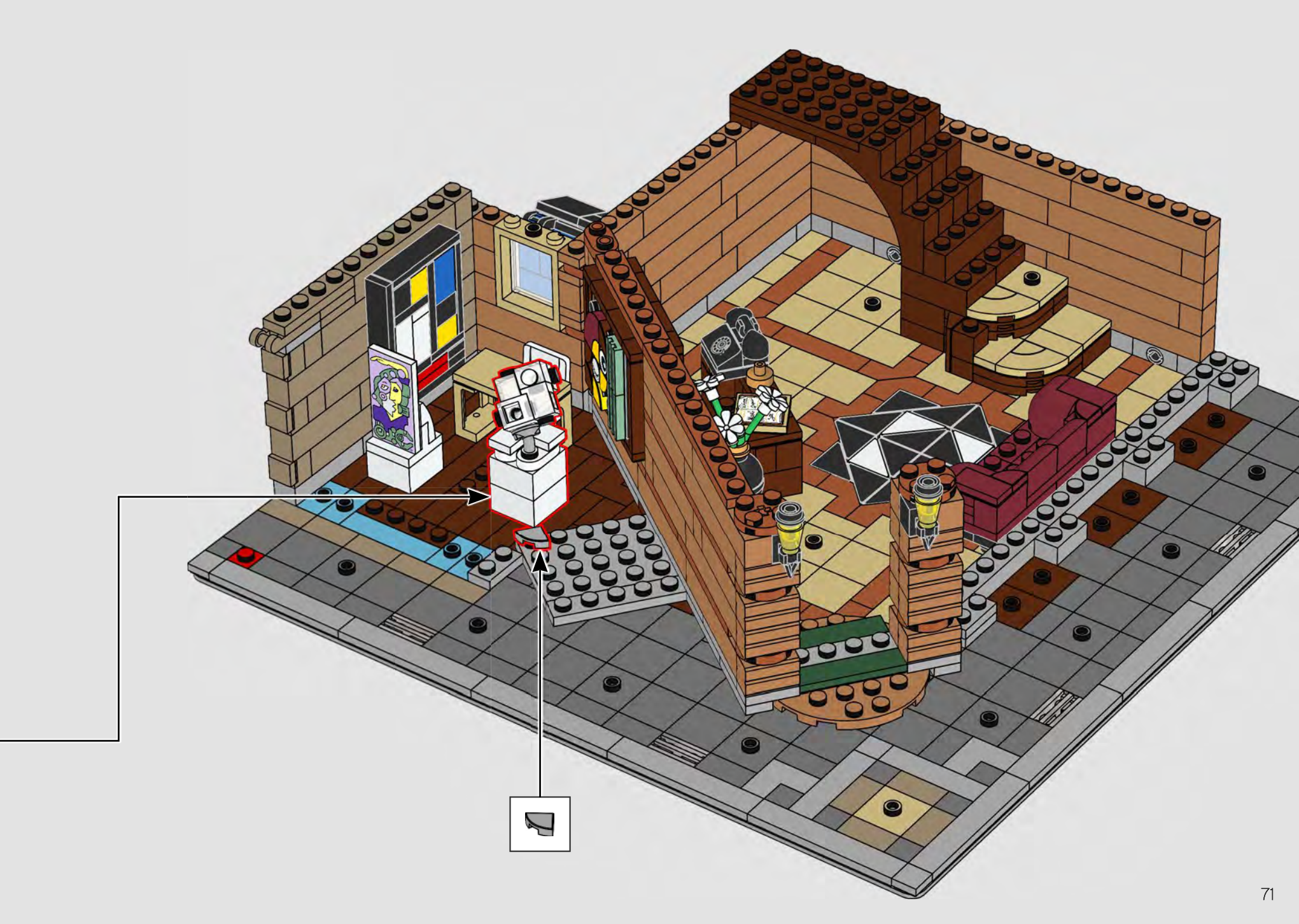

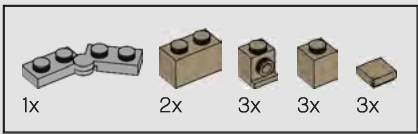

102

1

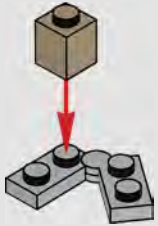

2

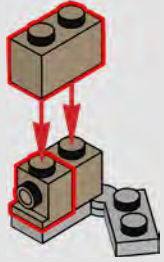

3

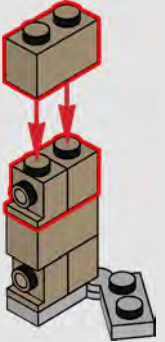

4

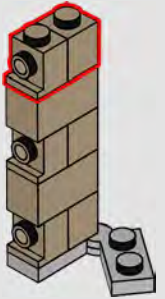

5

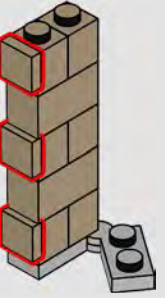

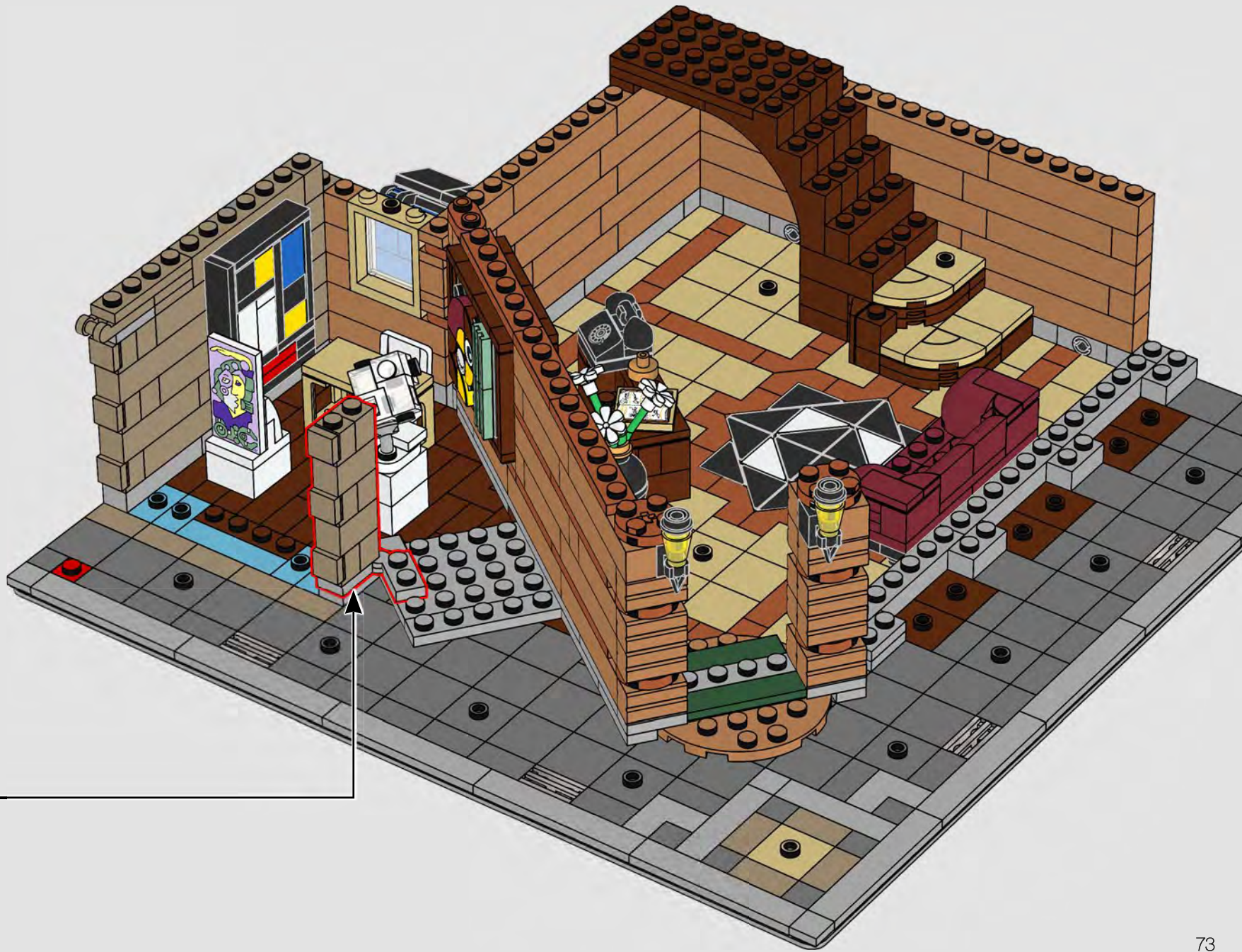

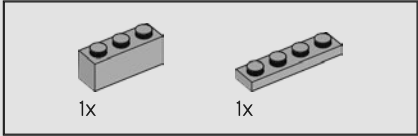
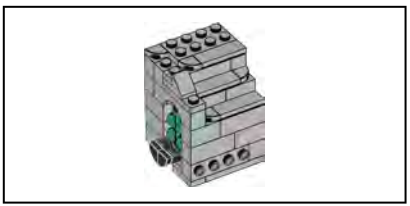

103

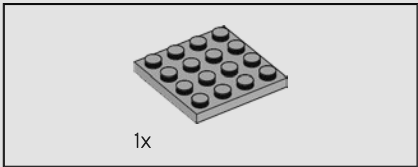
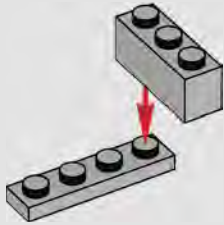

104

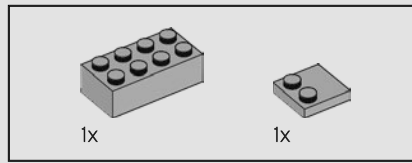
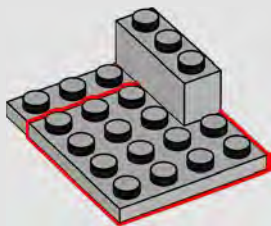

105

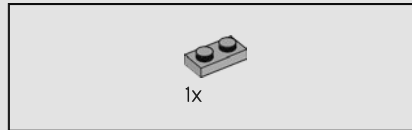
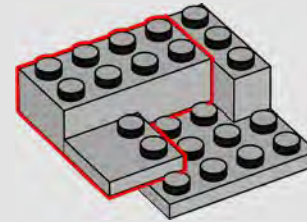

106

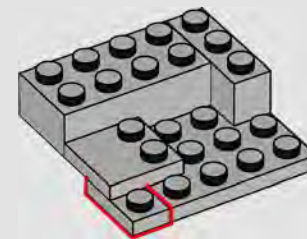

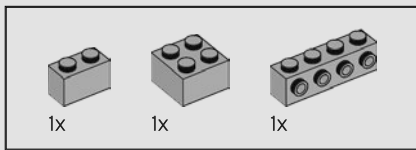

107

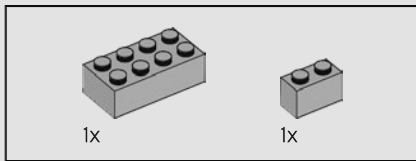
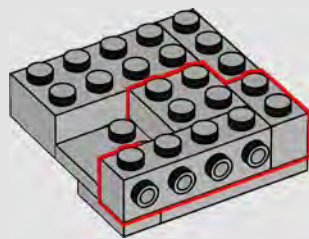

108

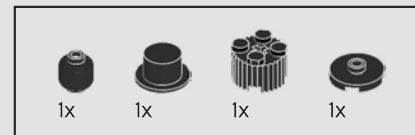
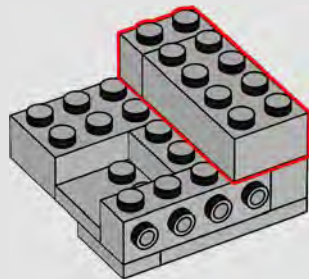

109

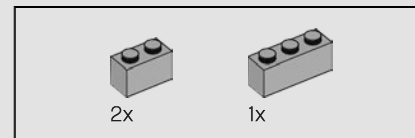
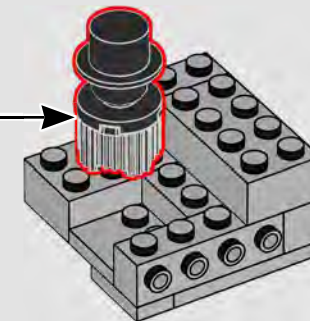
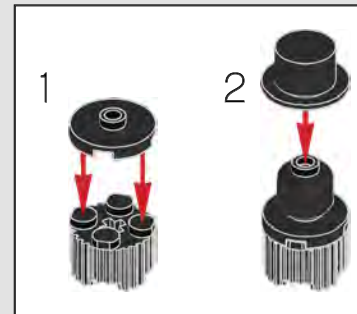

110

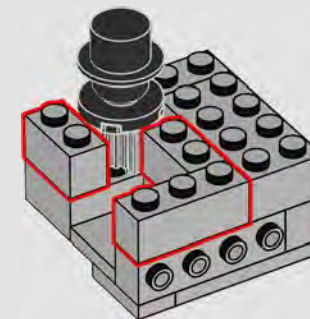

This bust is by the same artist who carved the white bust in the lobby of the 10224 Town Hall set.

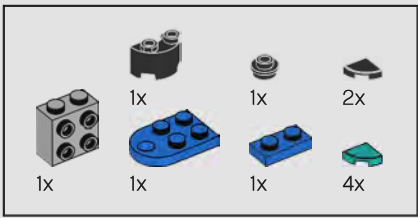

111

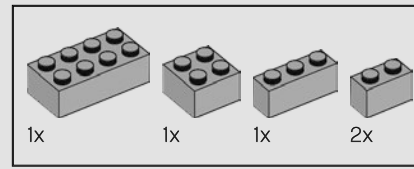
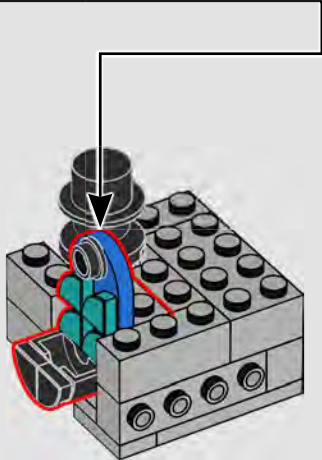
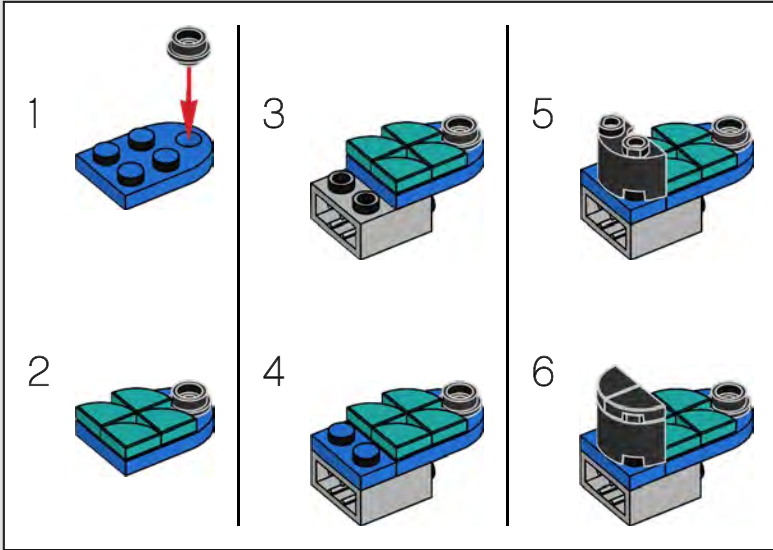

112

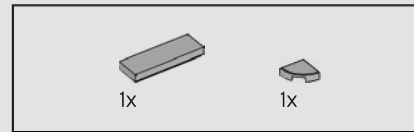
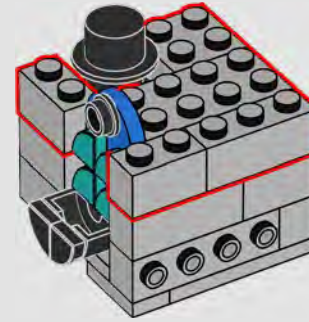

113

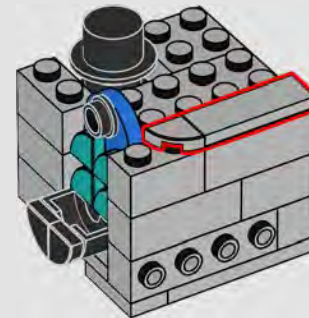

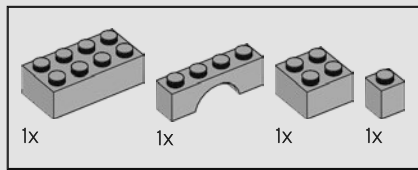

114

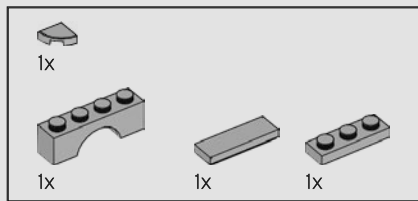
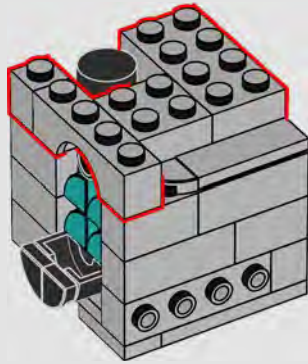

115

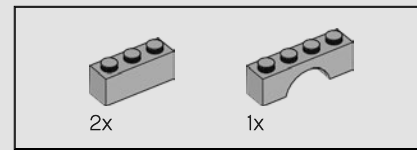
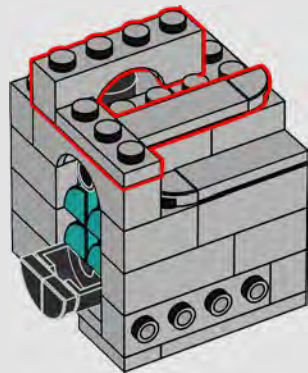

116

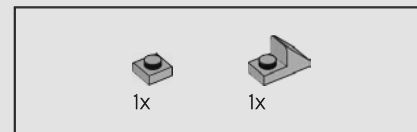
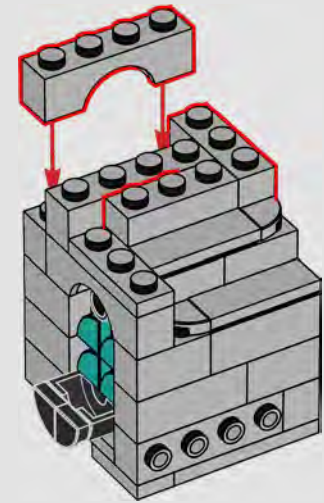

117

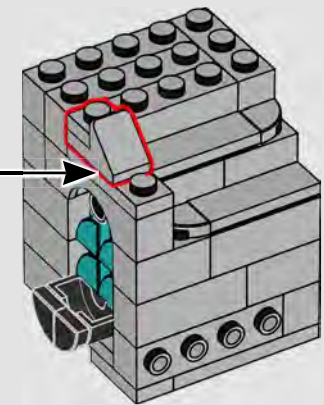
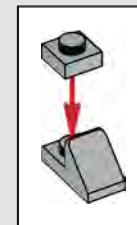

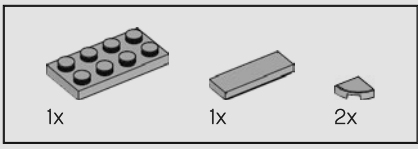

118

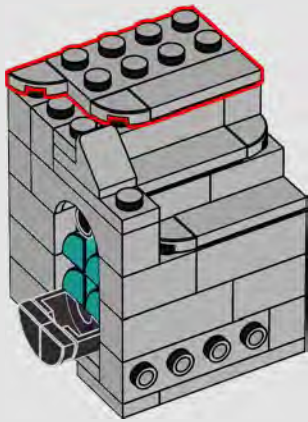

119

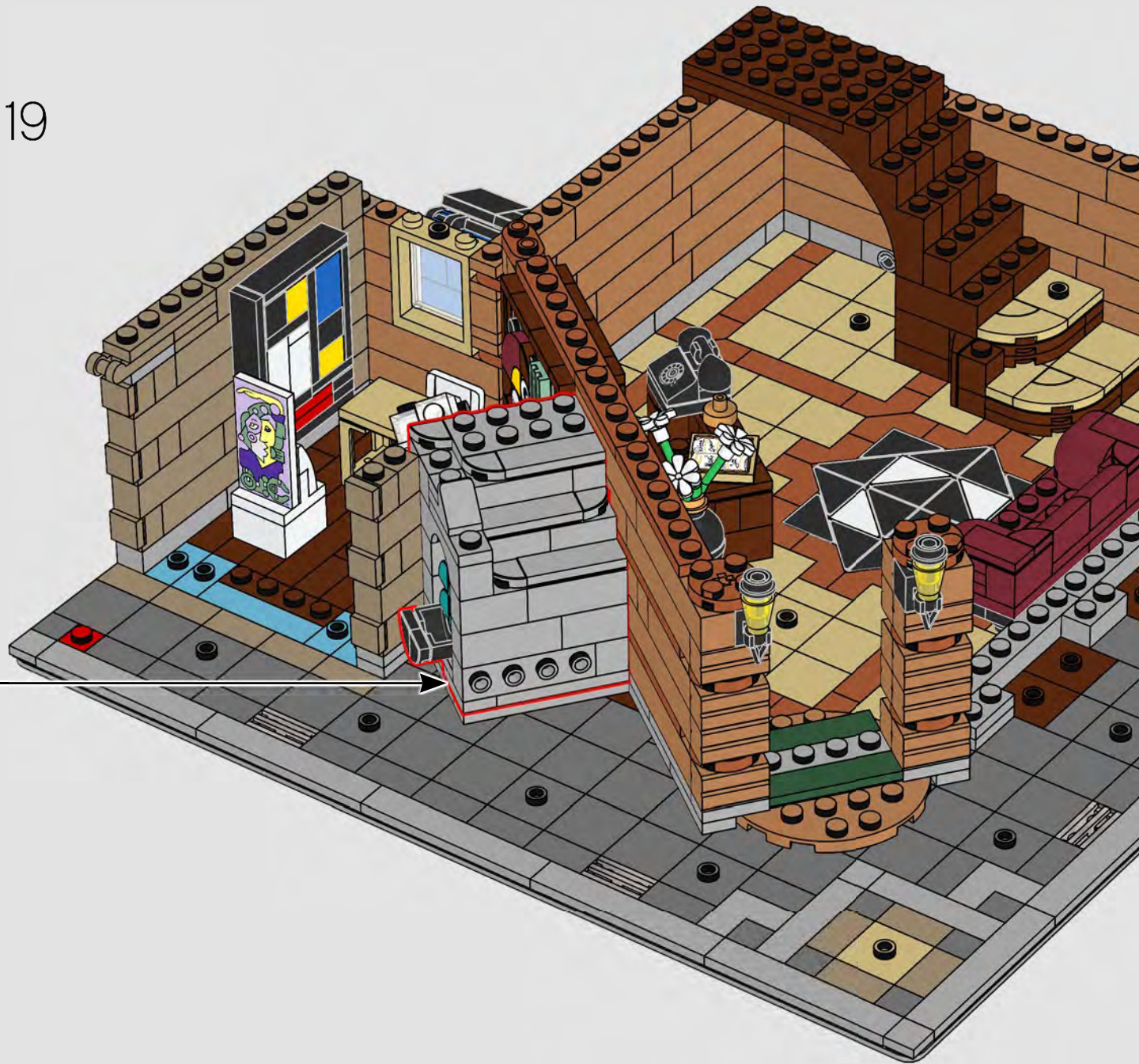

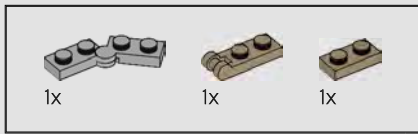

120

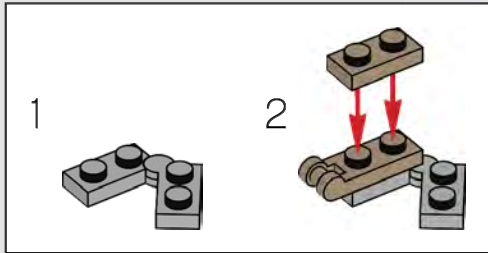

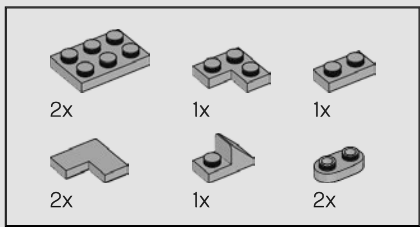

121

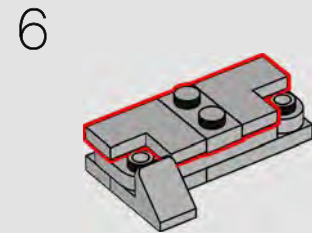
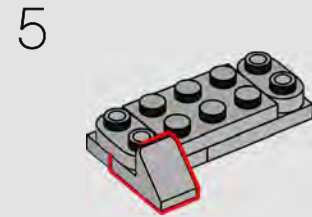
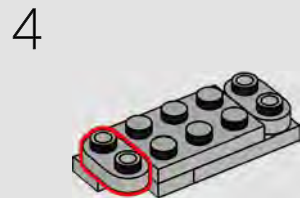
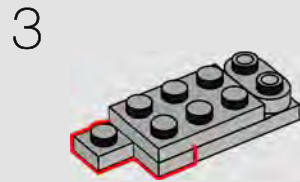
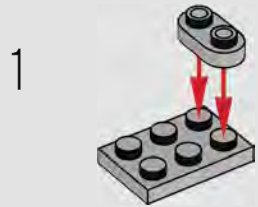



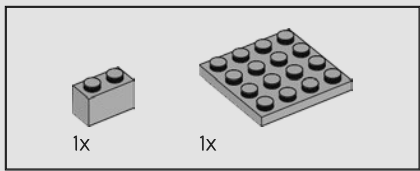

122

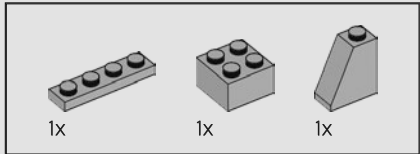
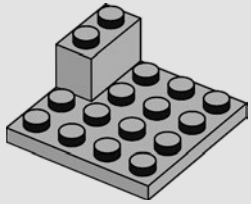

123

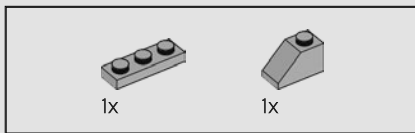
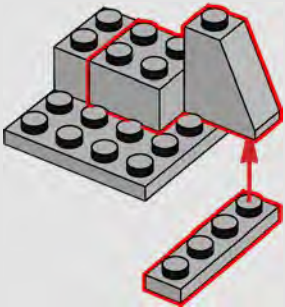

124

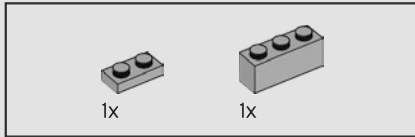
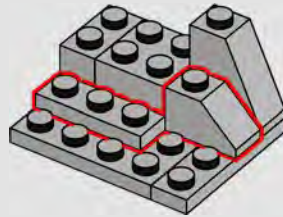

125

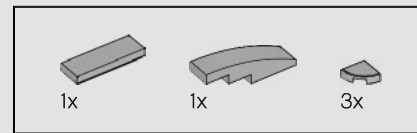
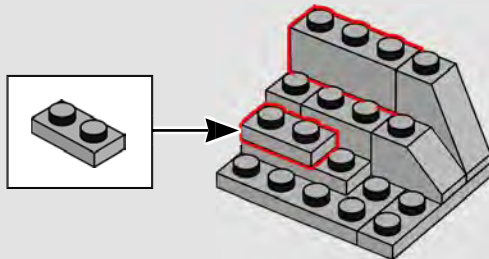

126

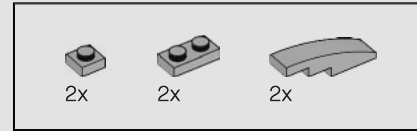
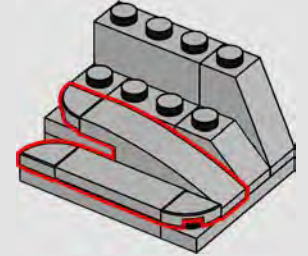

127

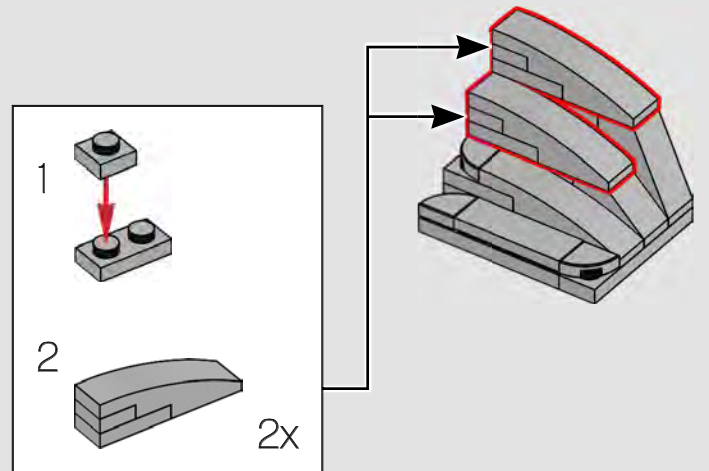

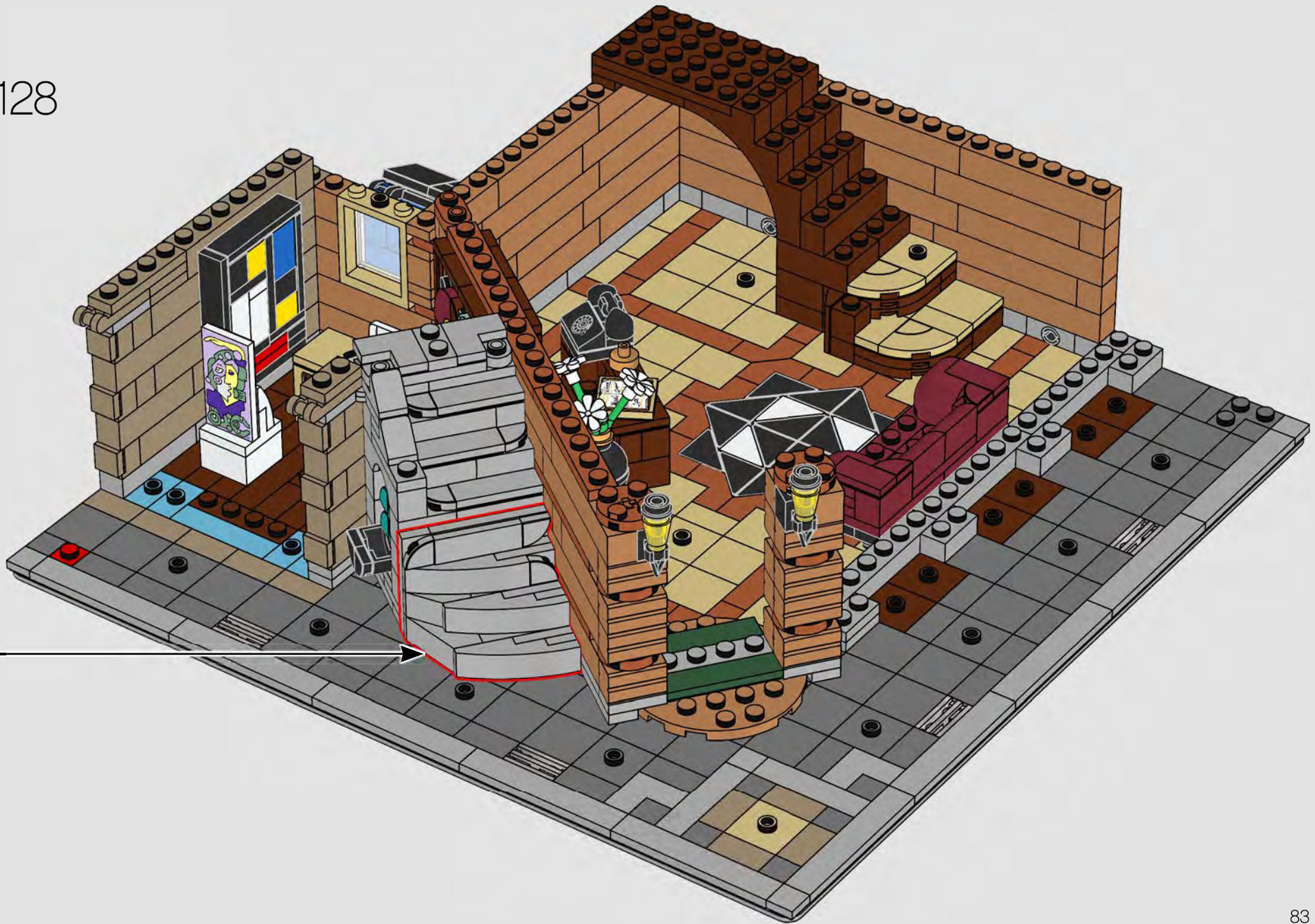

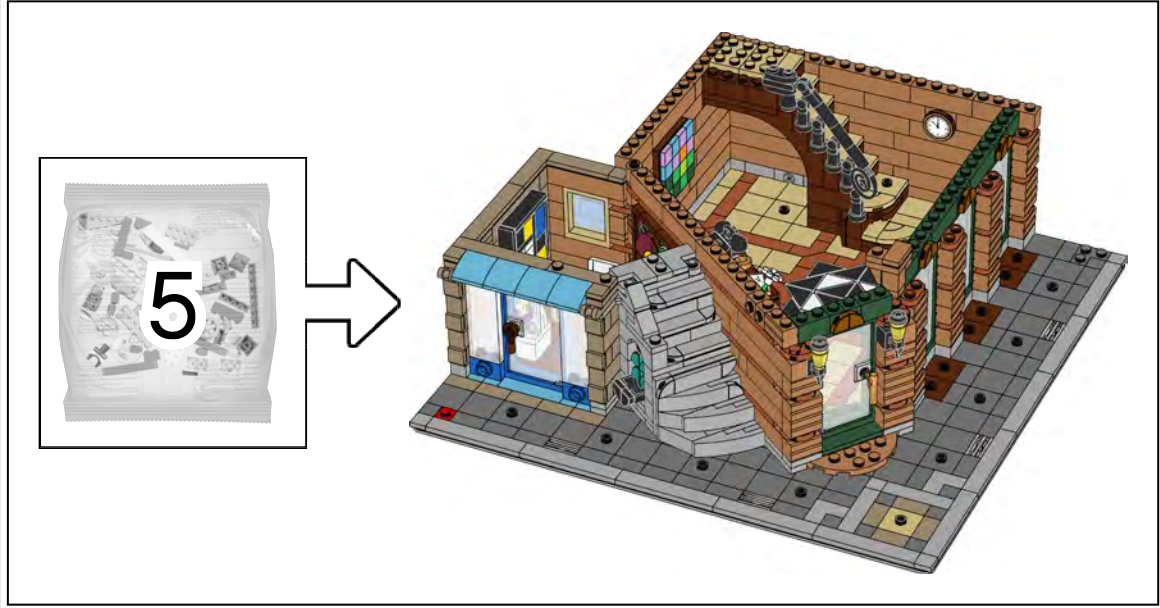

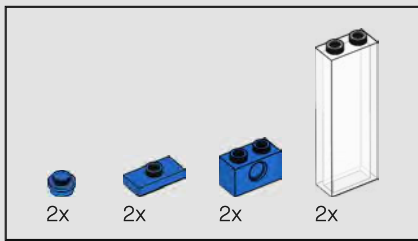

129

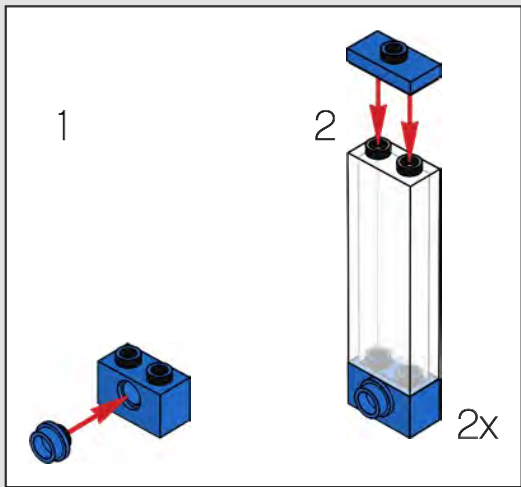

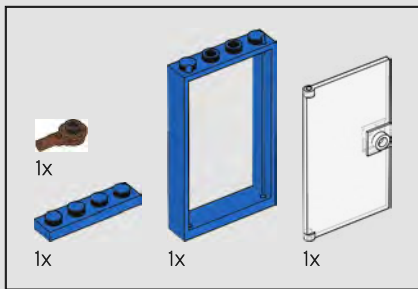

130

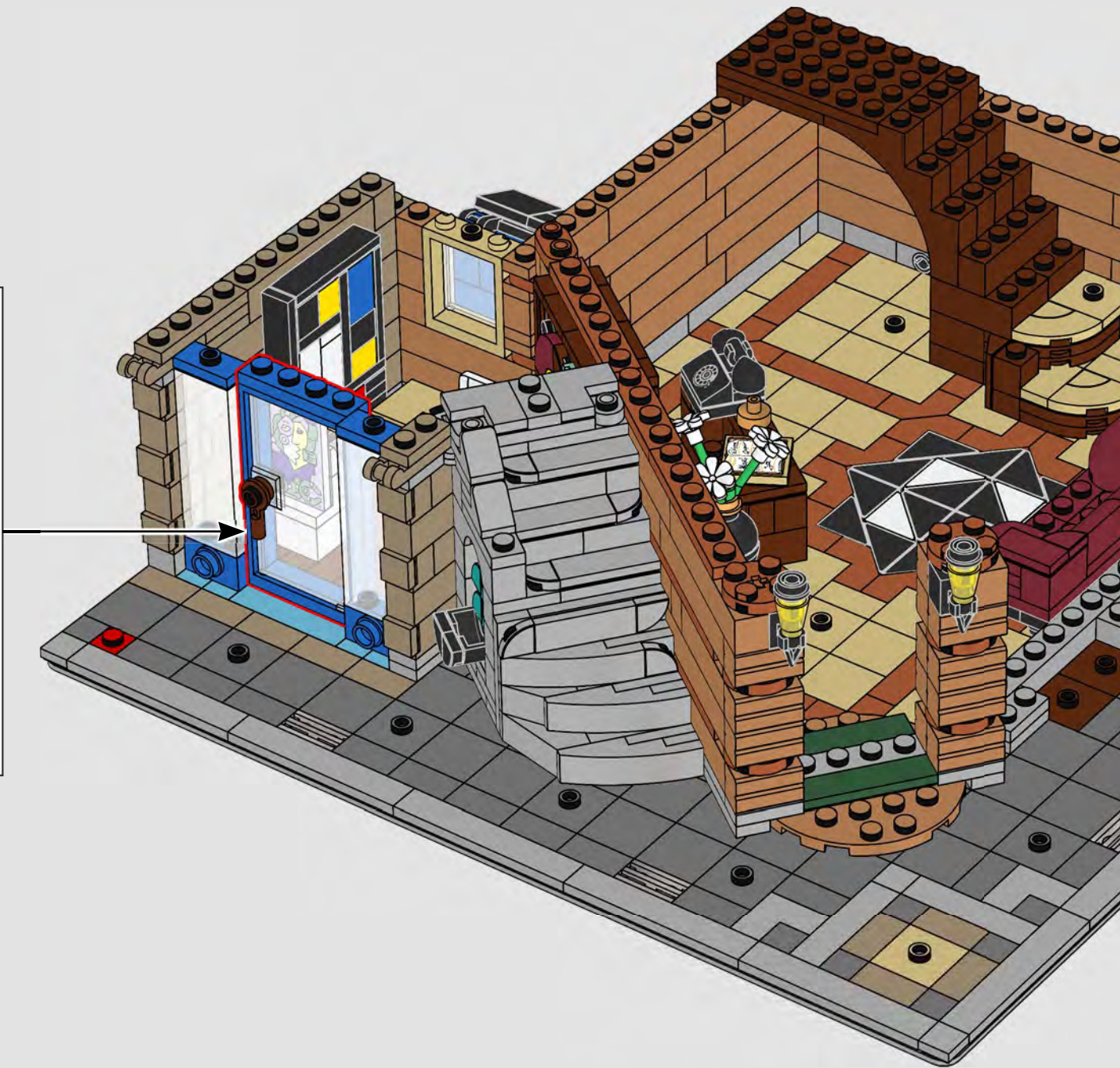
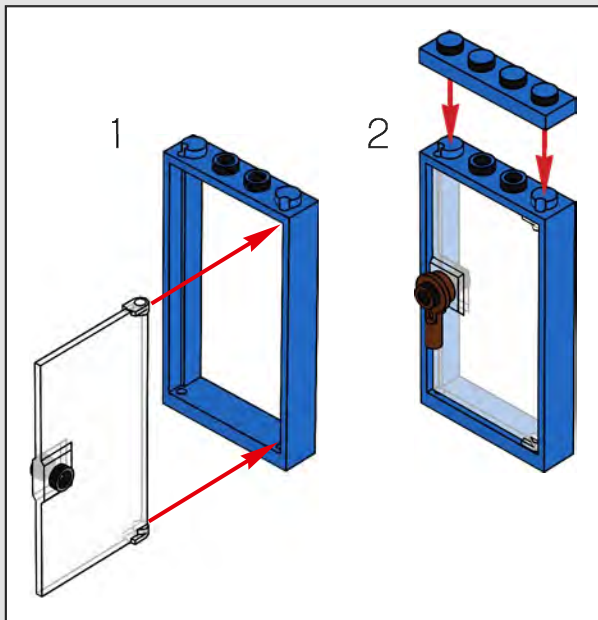

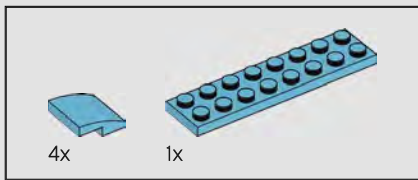

131

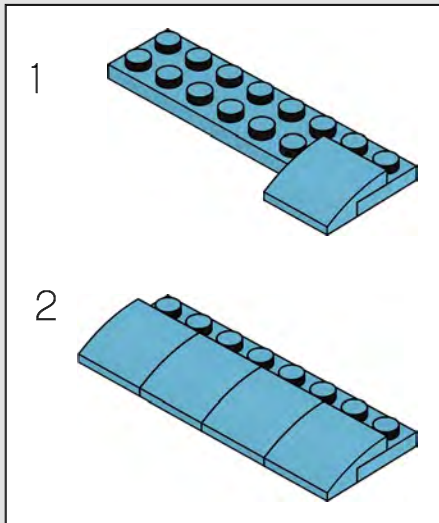

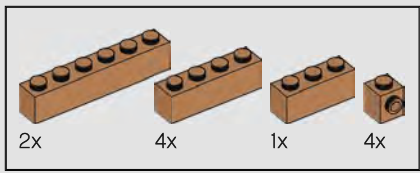

132



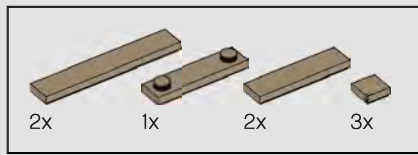

133



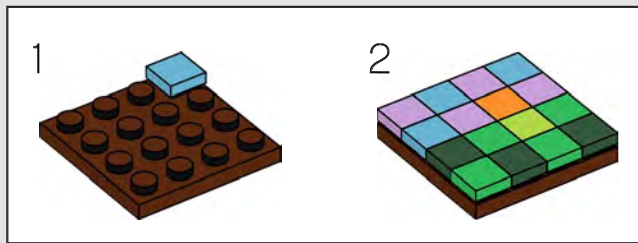
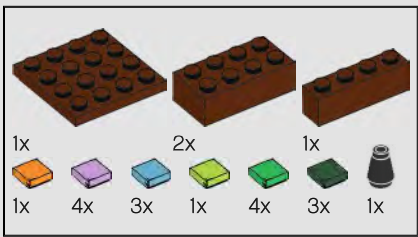

134



This painting is by the Artist whose studio is in the loft of the 10243 Parisian Restaurant set.

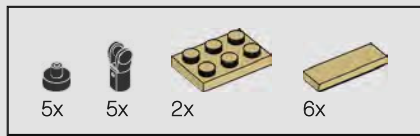

135

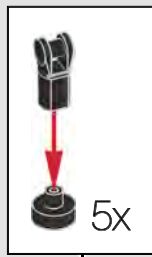



136

1



2

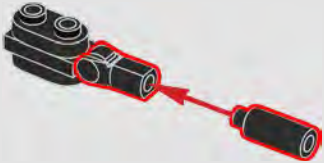

3

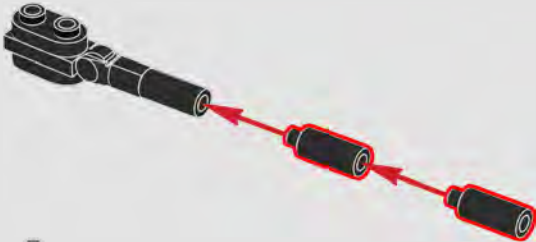

4



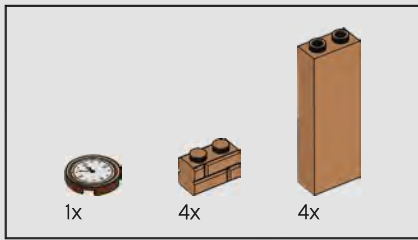

137

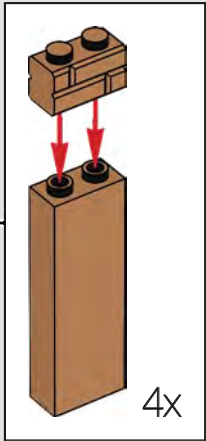

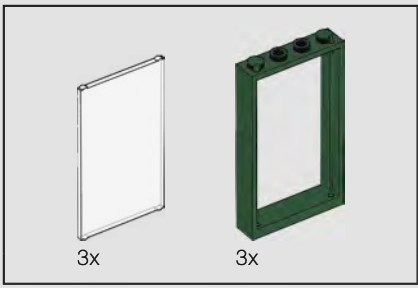

138

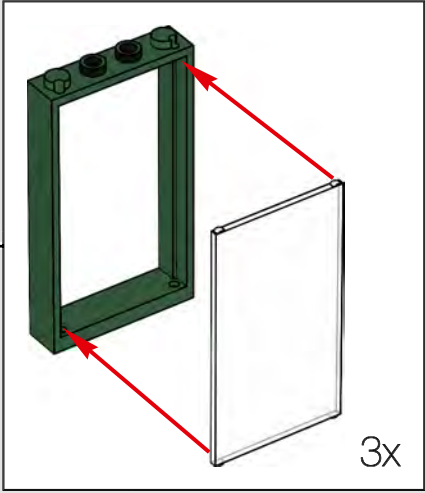

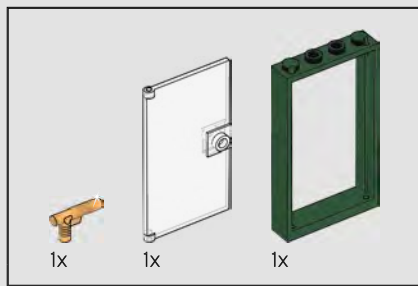

139

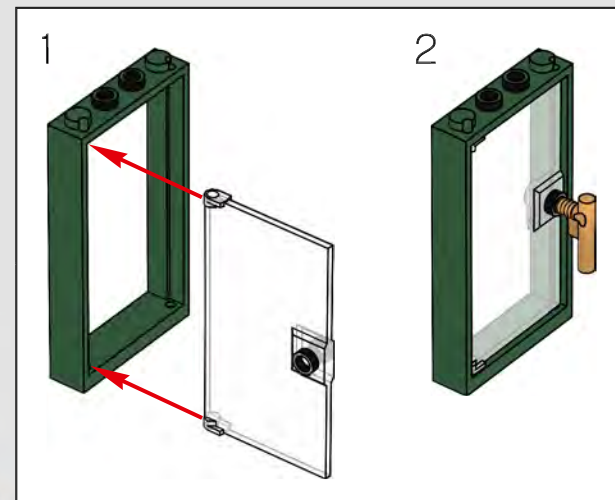

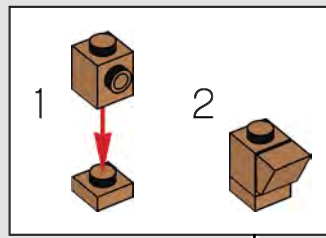
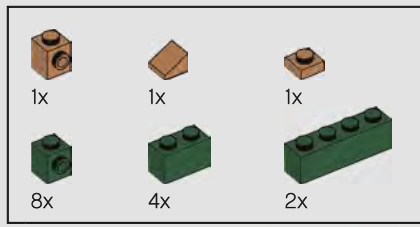

140





141



-  12x
-  20x
-  1x
-  1x
-  1x

142

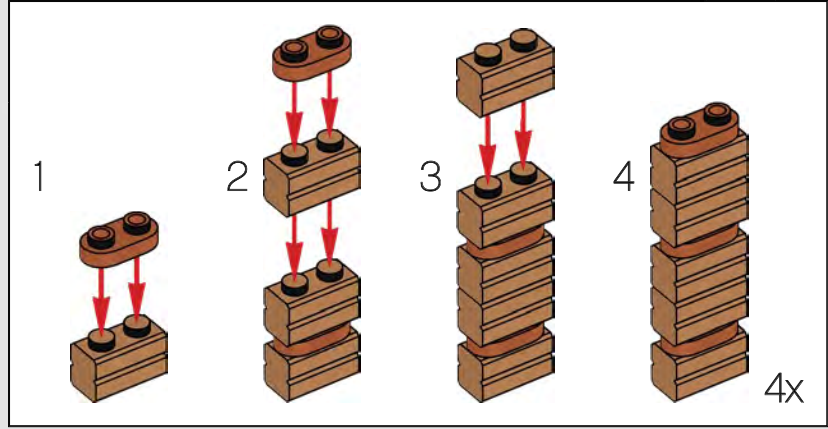
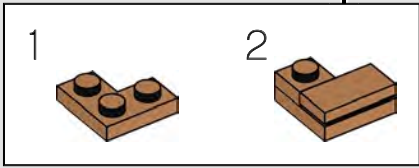

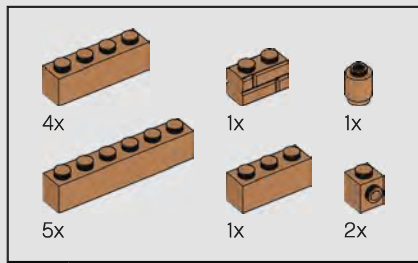

143



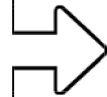

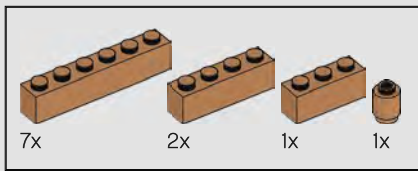

144



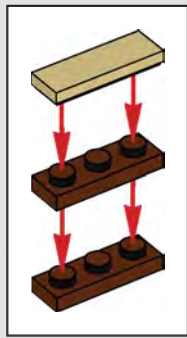
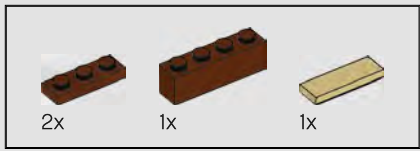

145



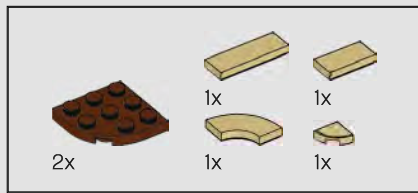

146

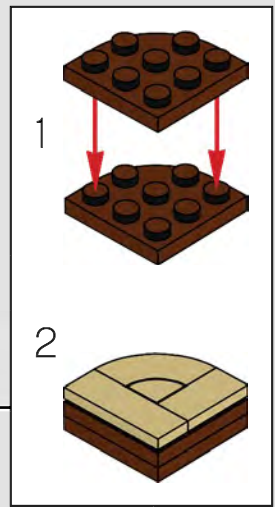
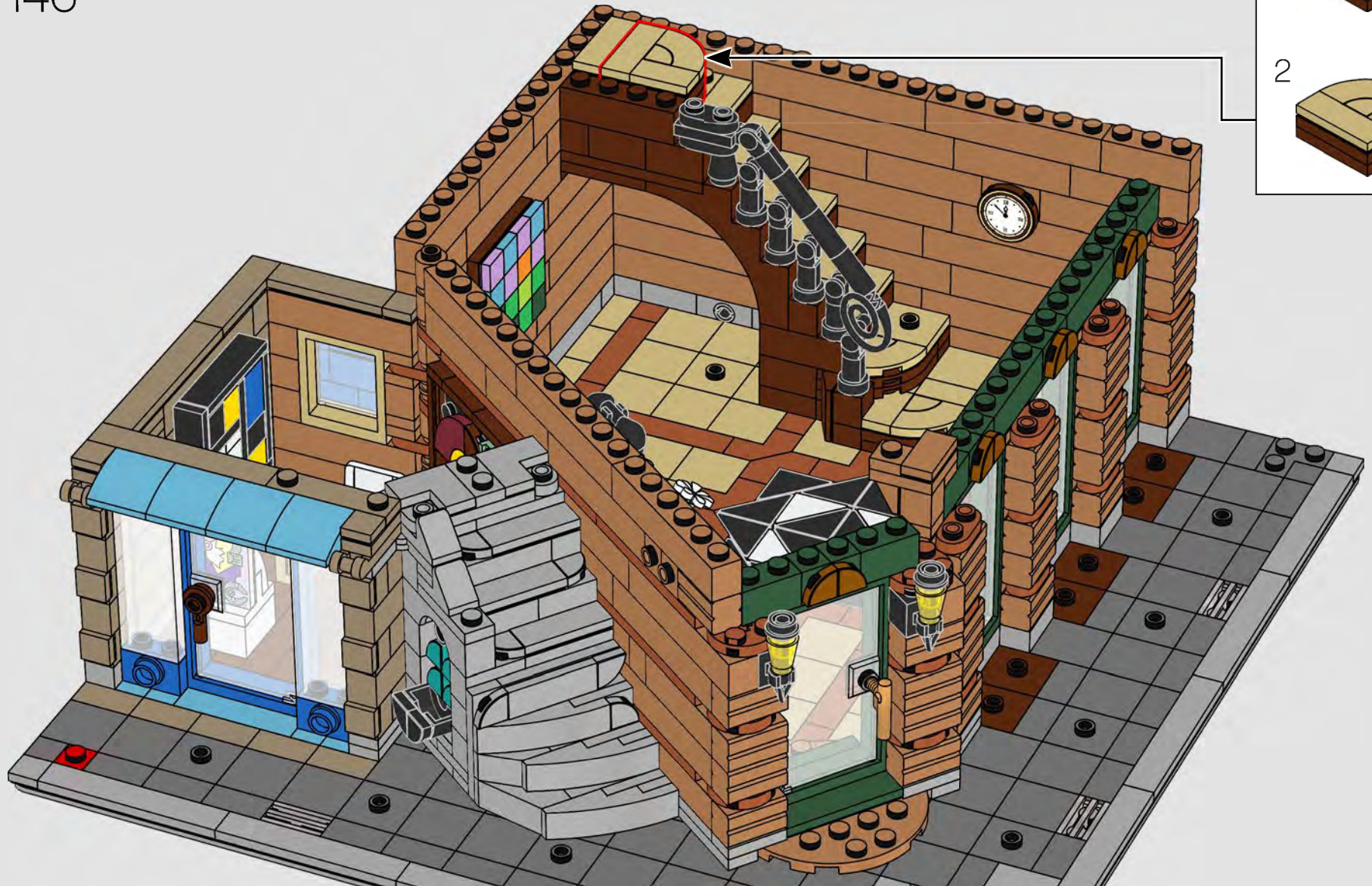



147

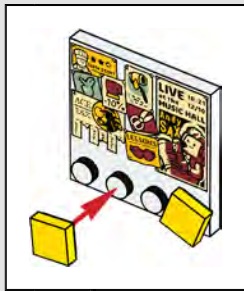

★ ★ ★ ★ ★
The posts on this Notice Board all advertise goods and services from elsewhere in previous Modular sets. See if you can recognise the references!



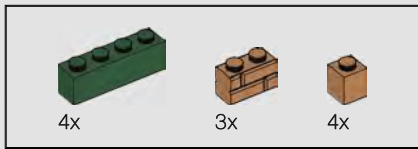

148

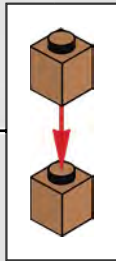

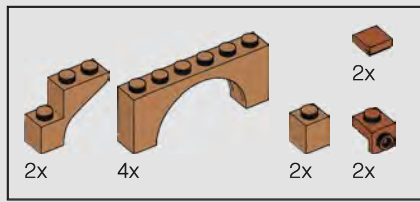

149

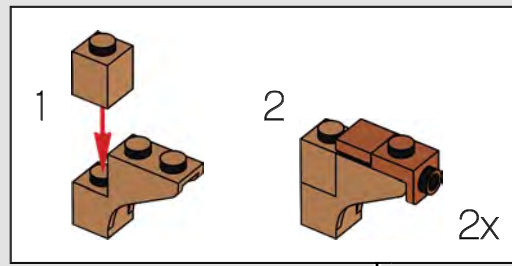

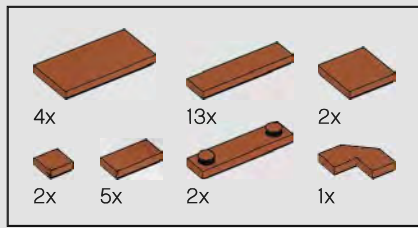

150



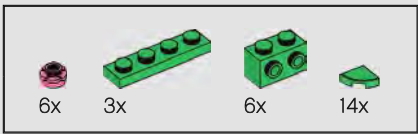

151

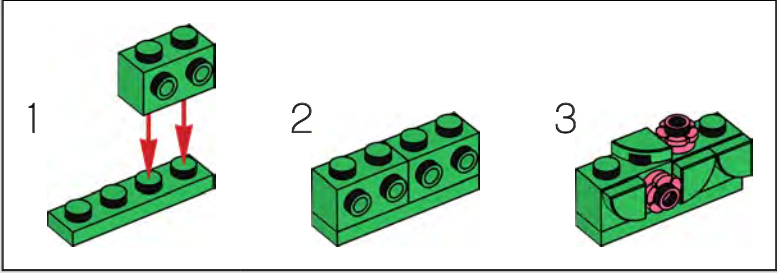
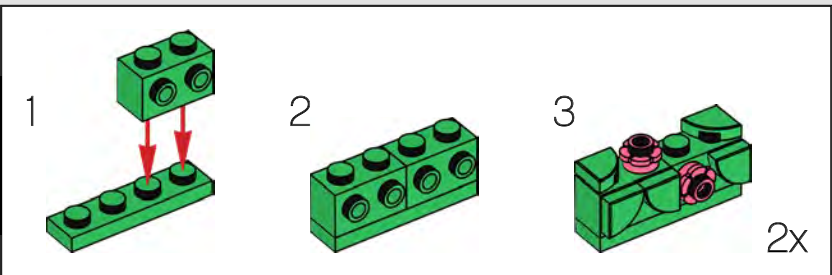

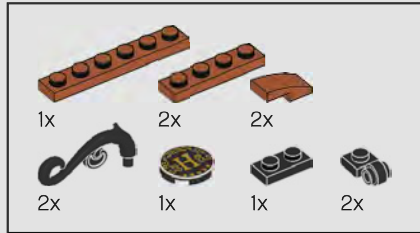

152

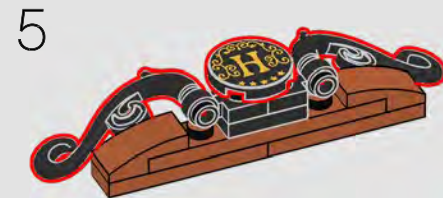
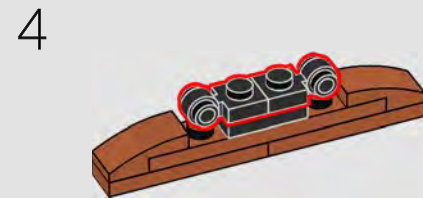
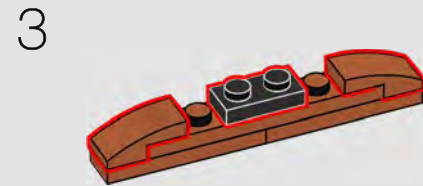
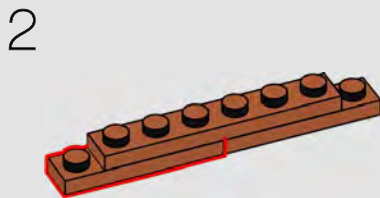
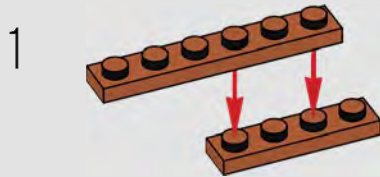



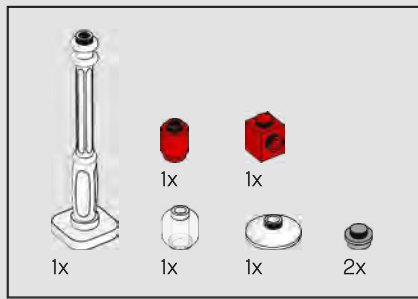

153

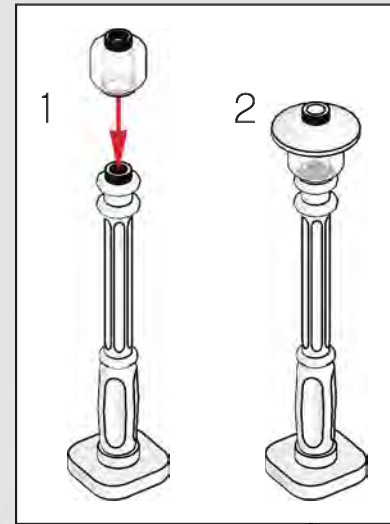
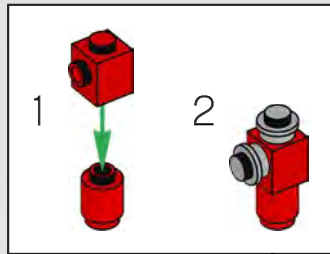

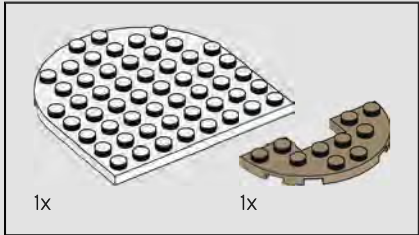
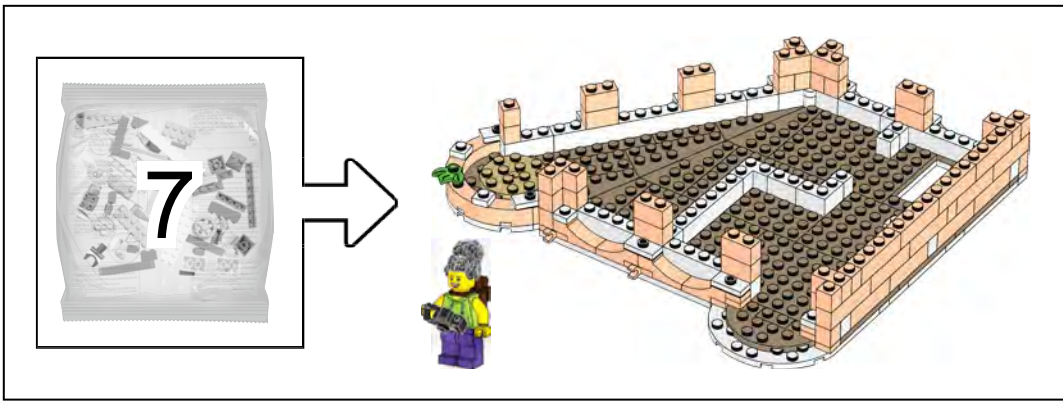

154

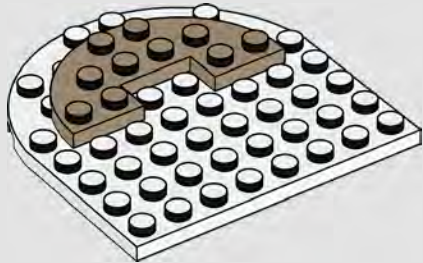

The Backpacker is travelling the world!
She's doing it on a budget, so is staying
in the Hotel's Economy room.

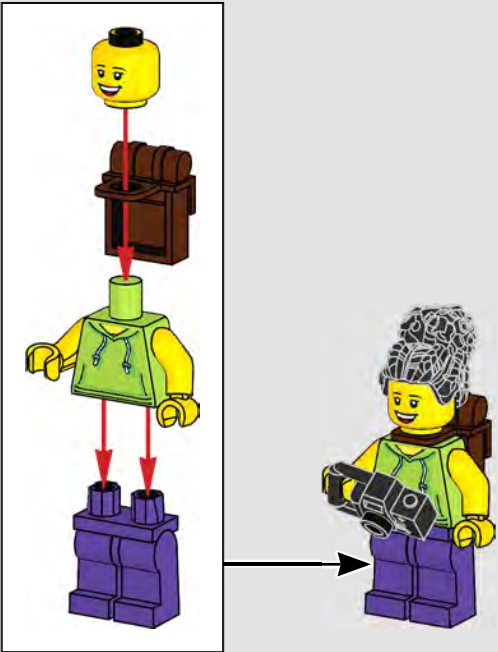

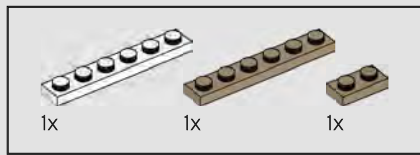

155

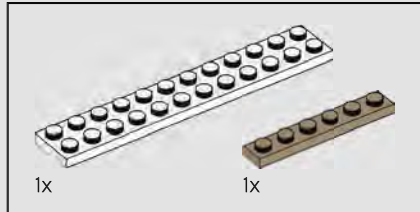
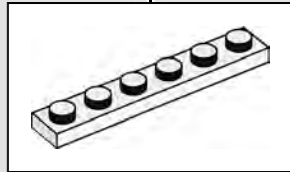
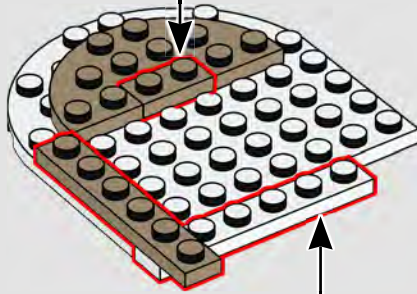

156

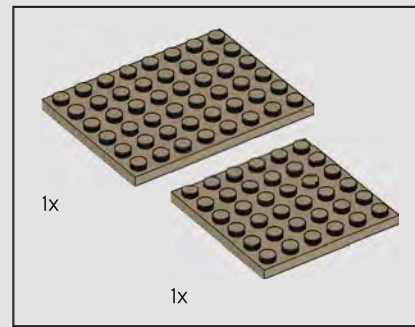
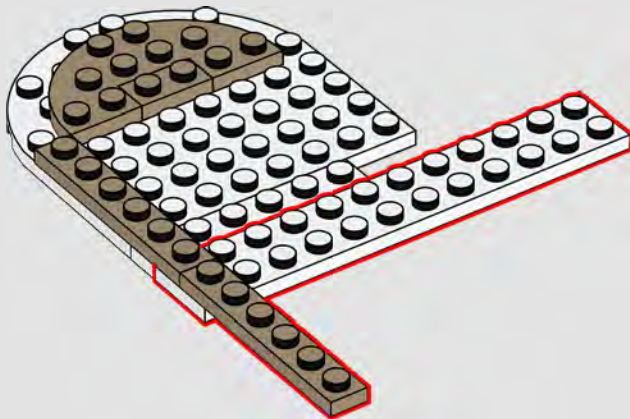

157

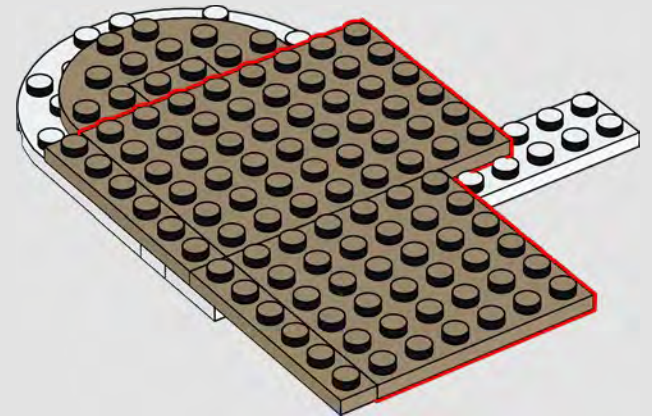

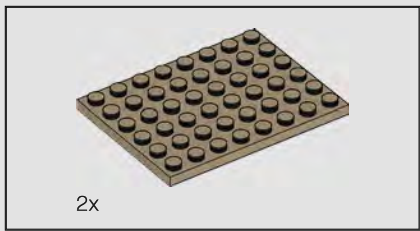

158

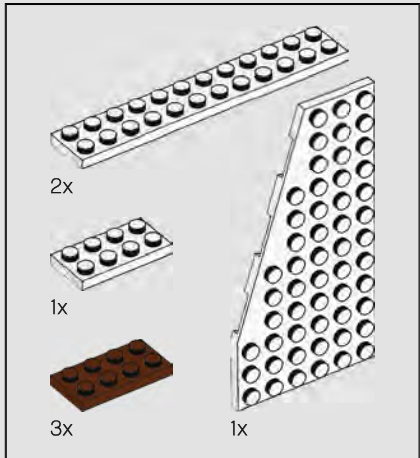
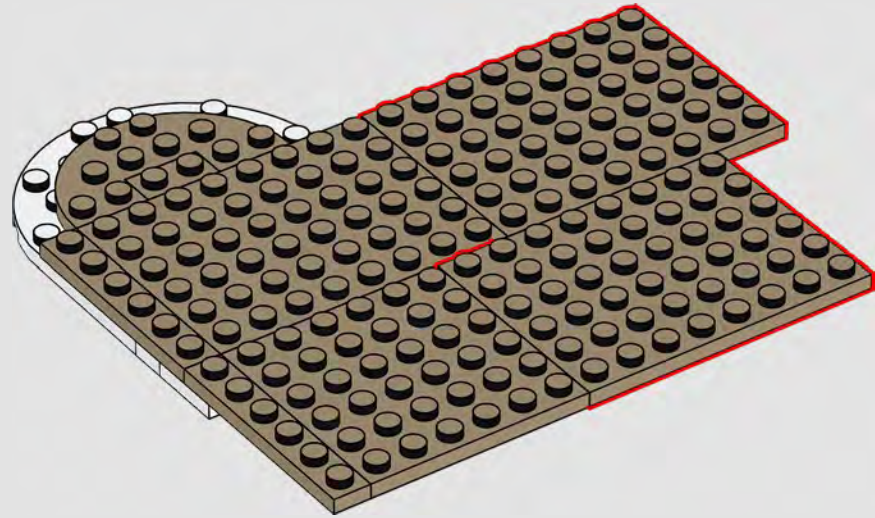

159

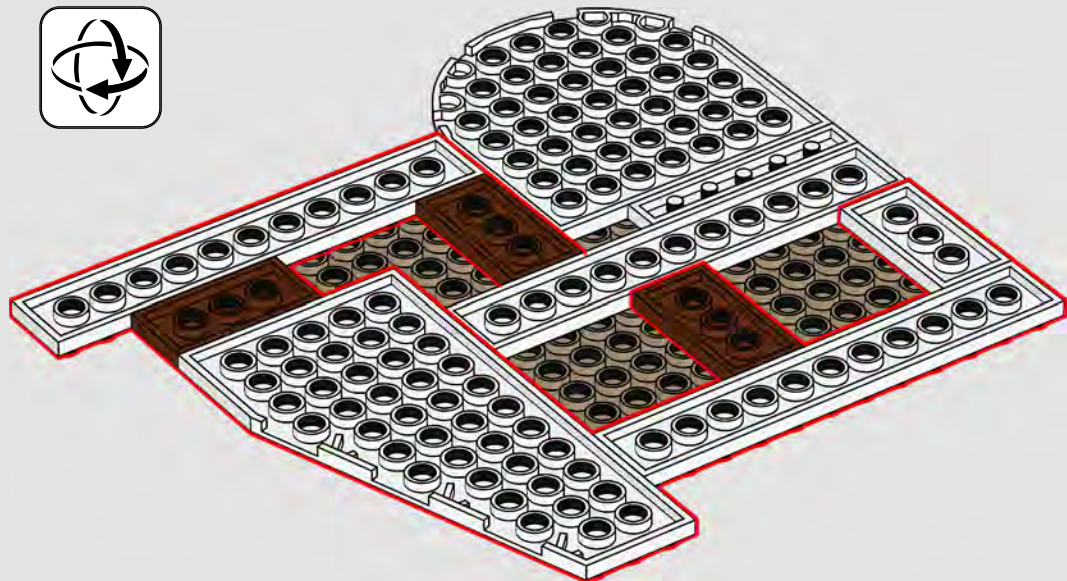
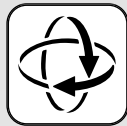

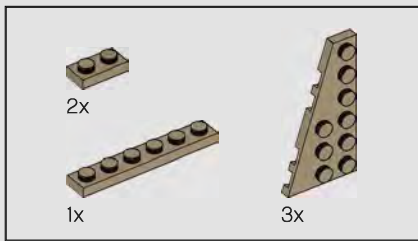

160

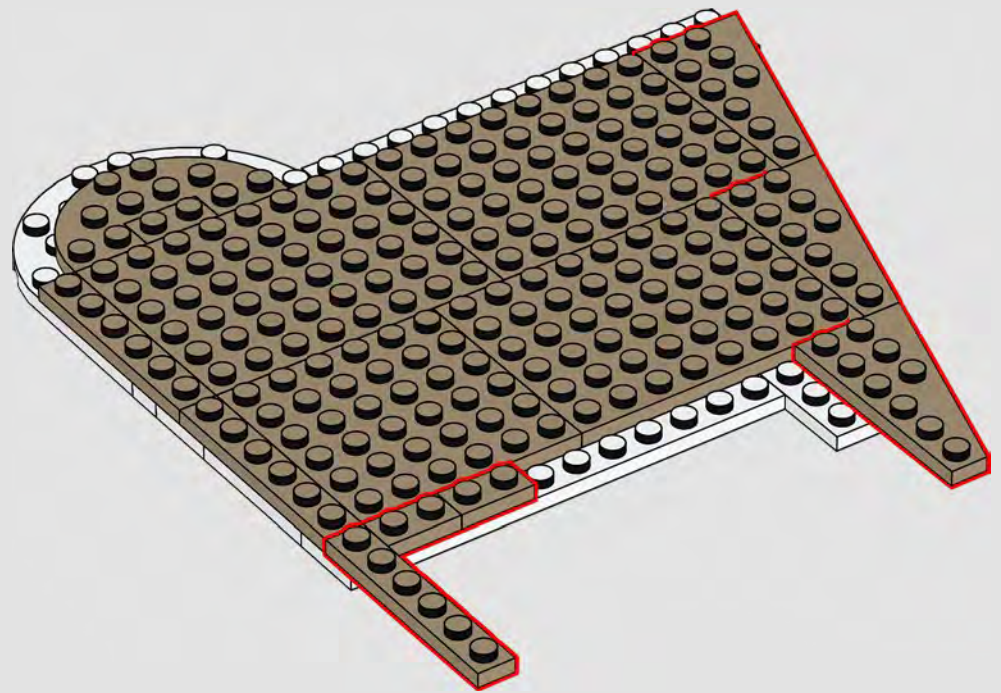

161

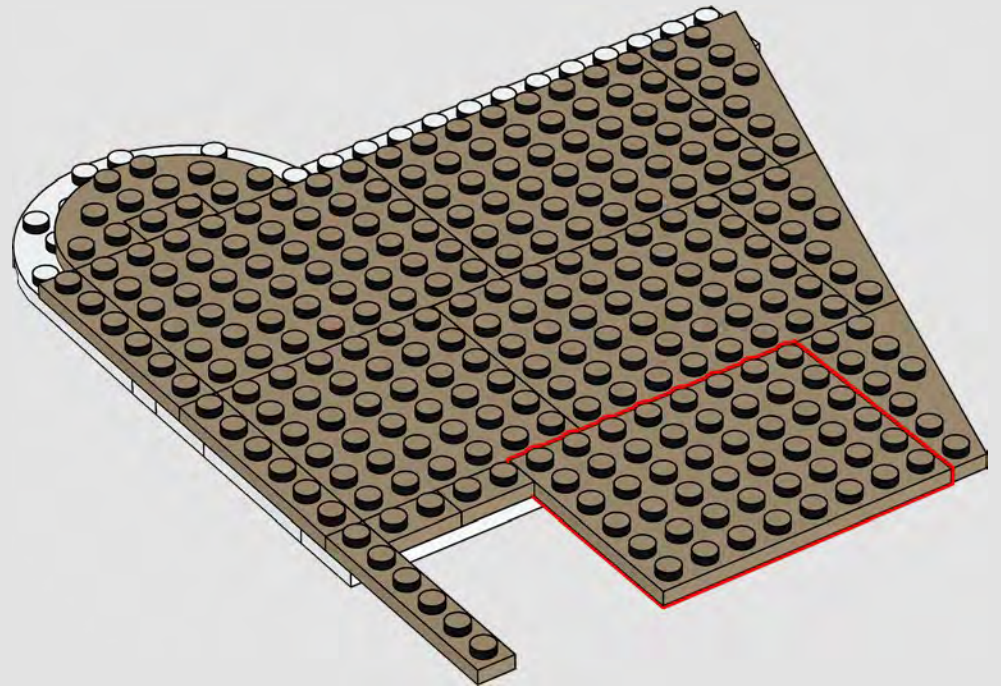

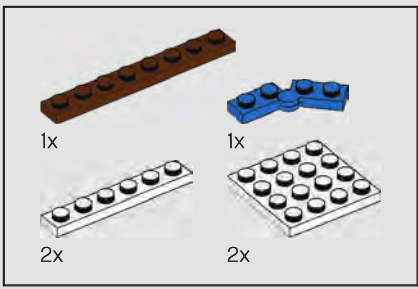

162

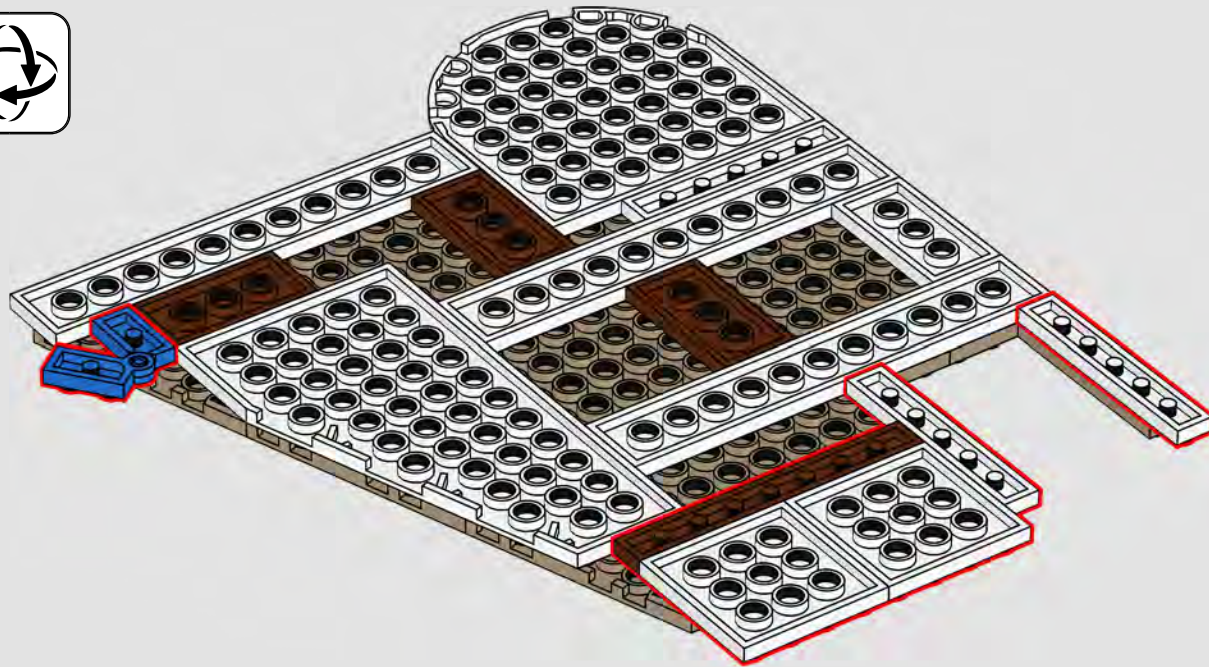

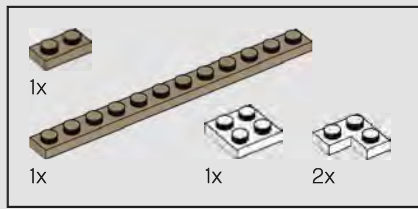

163

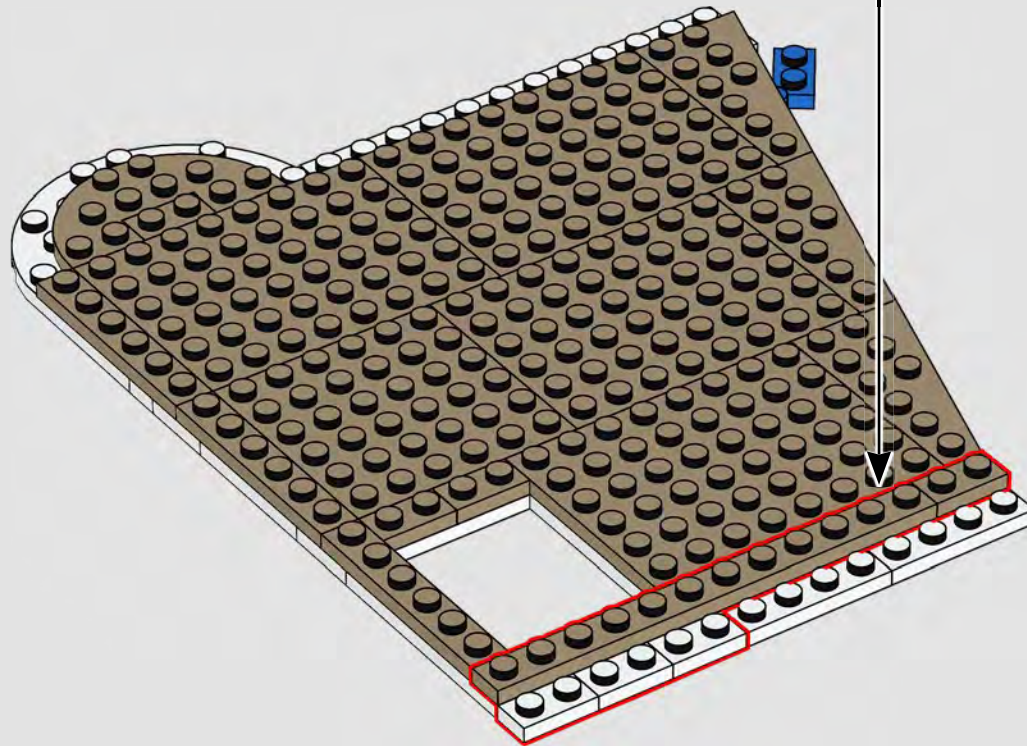
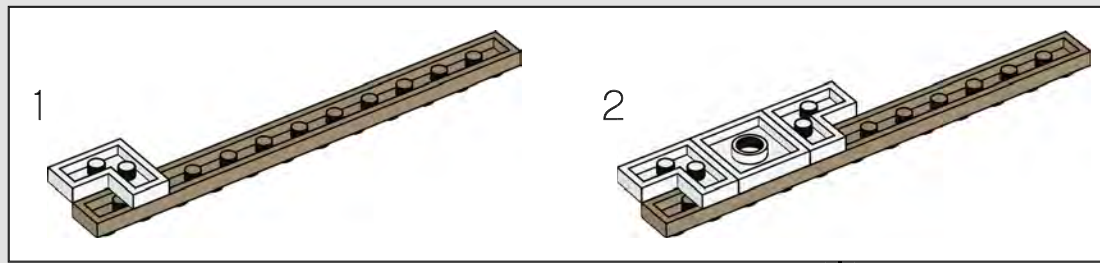

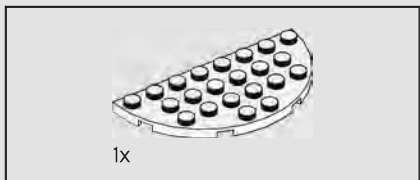

164

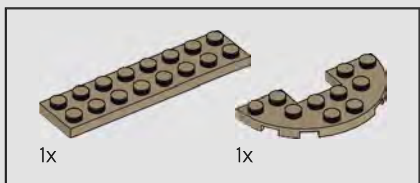
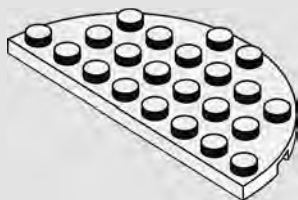

165

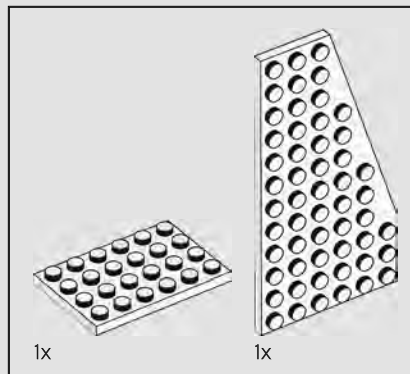
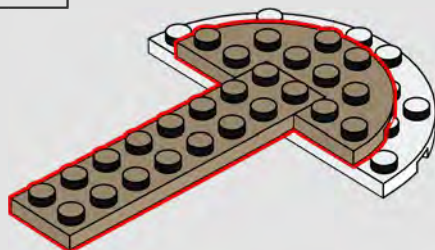

166

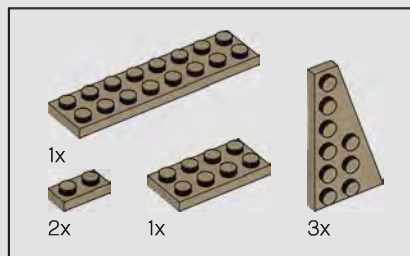
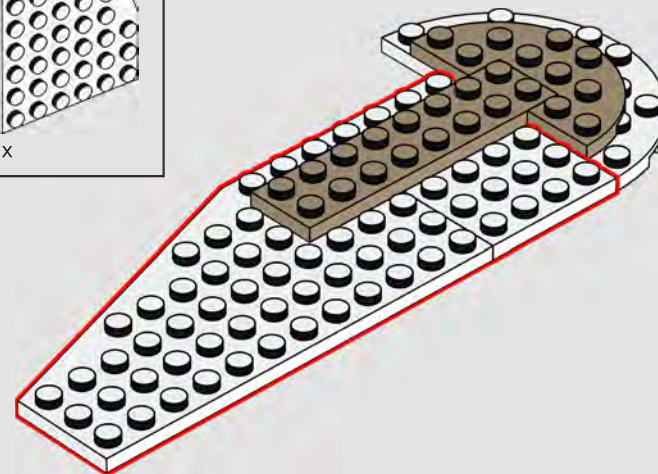

167

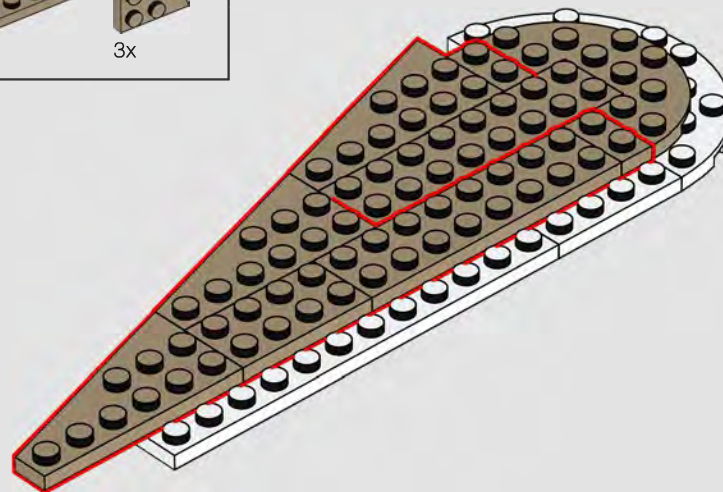

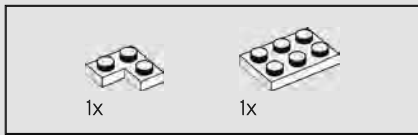

168

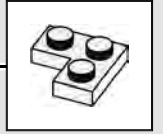
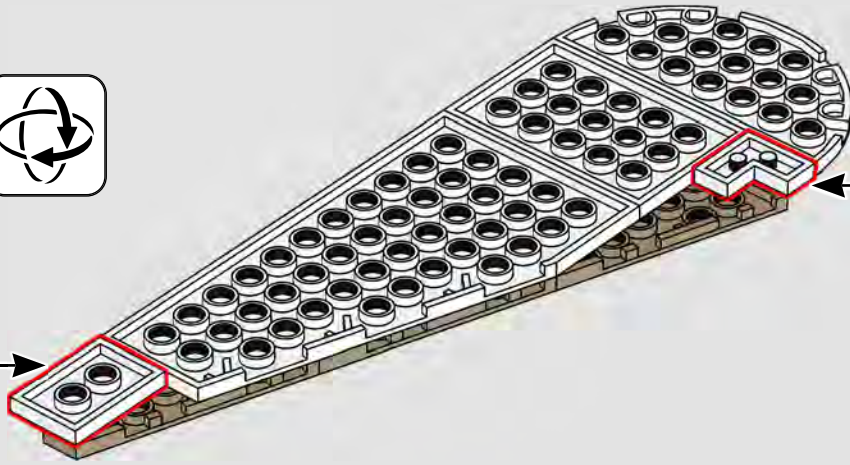
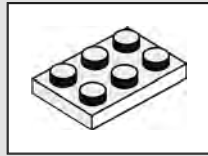

169

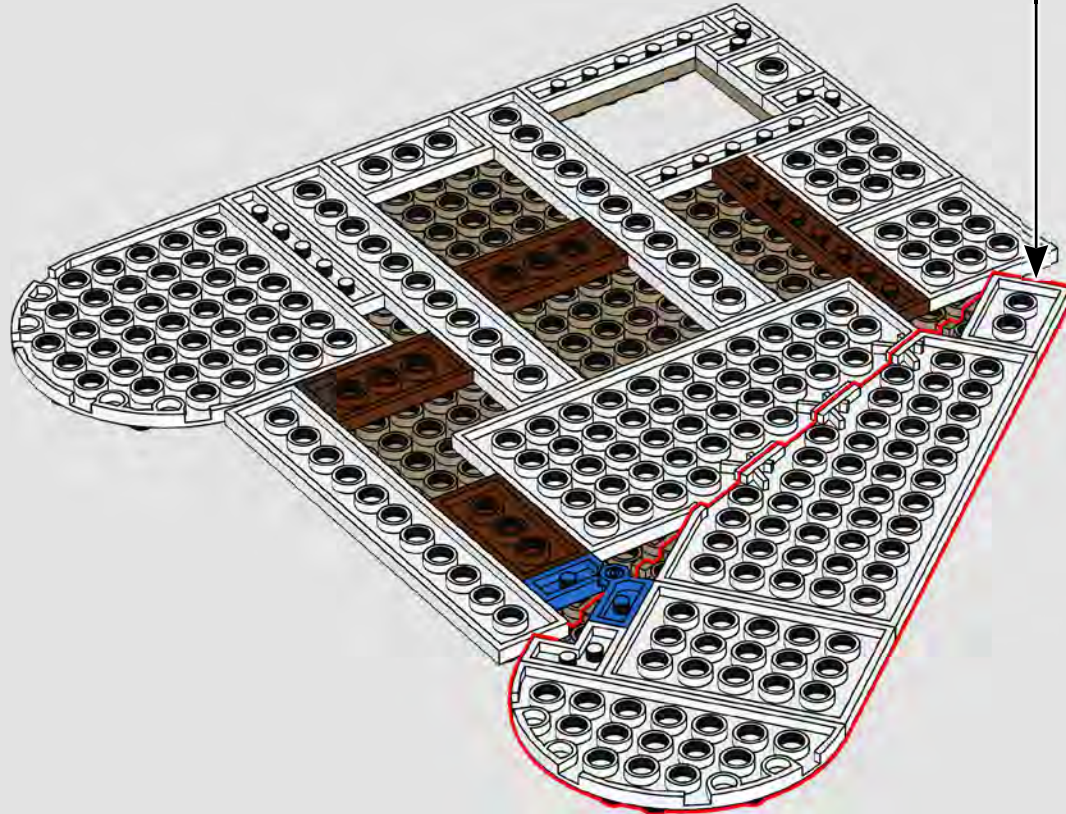

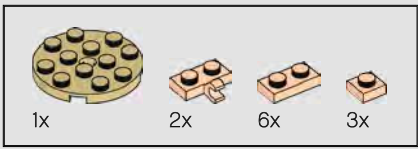

170

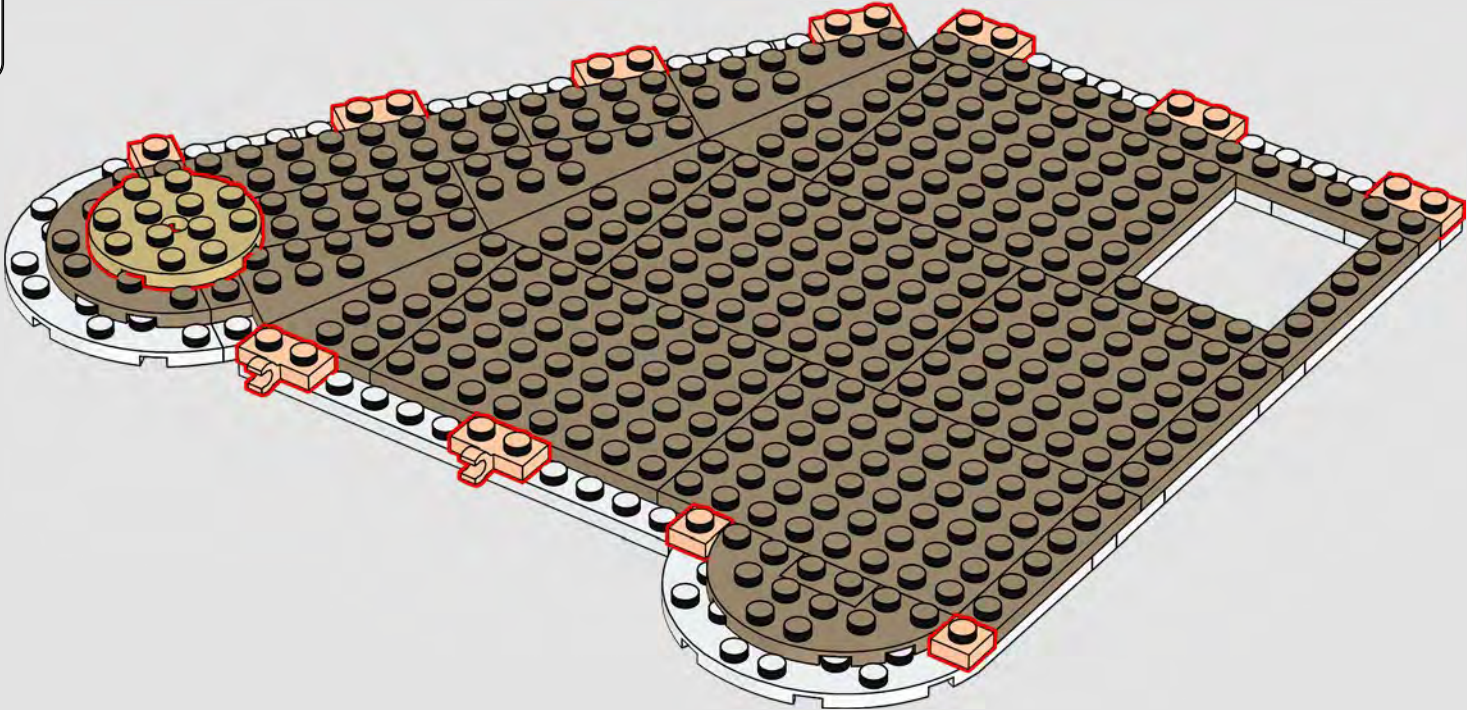

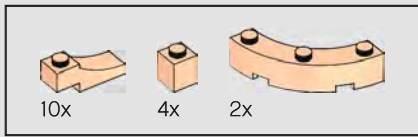

171

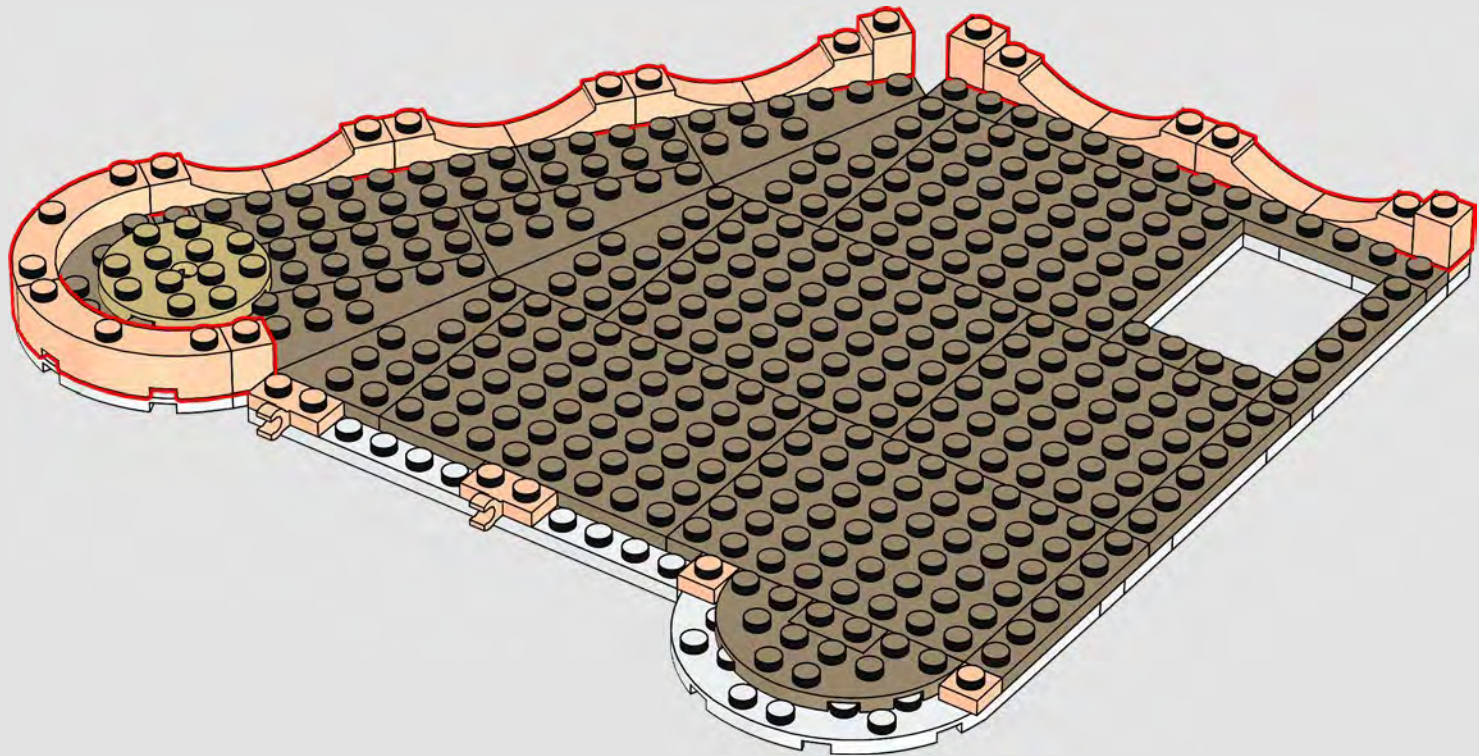

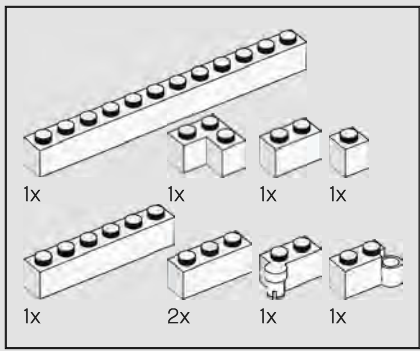

172

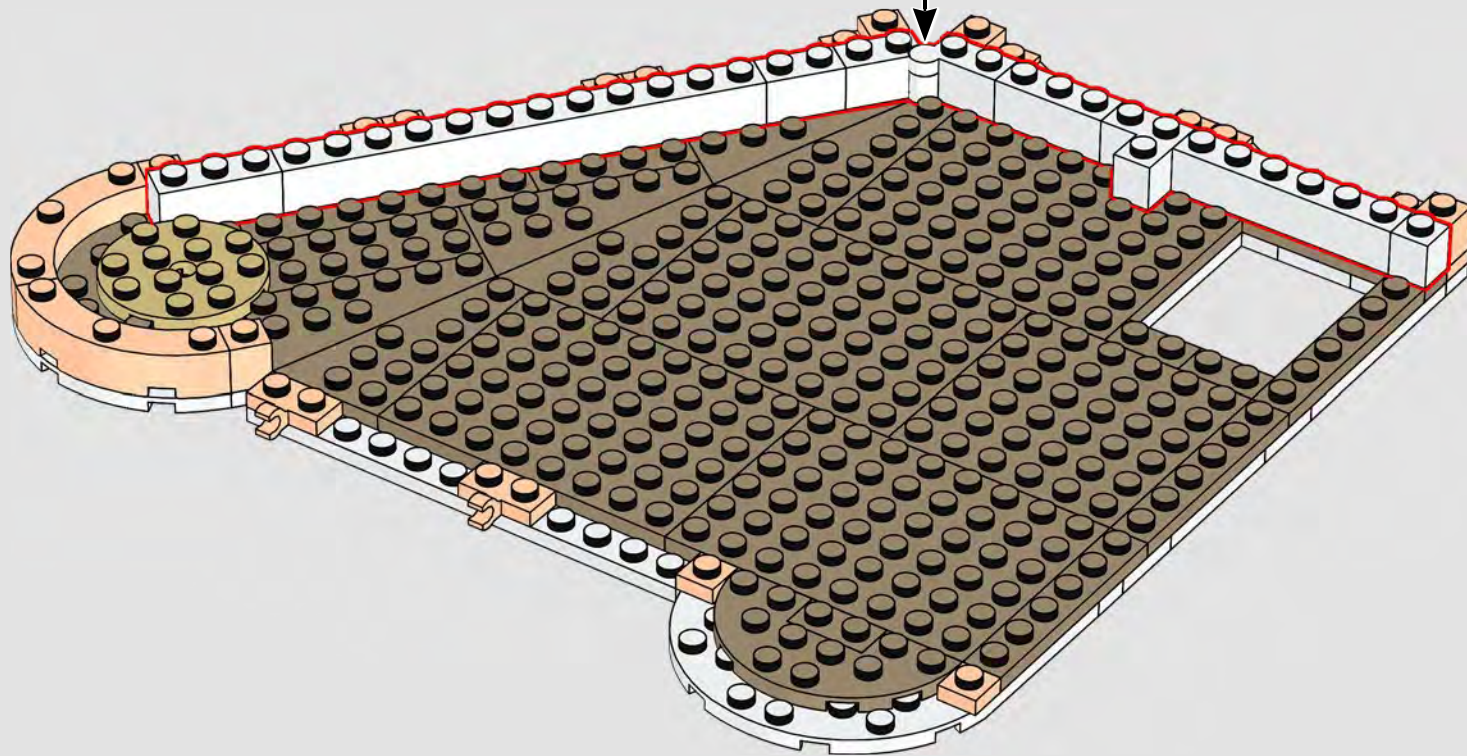
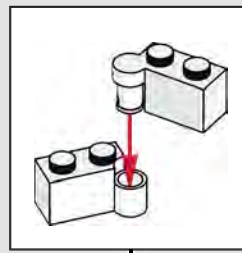

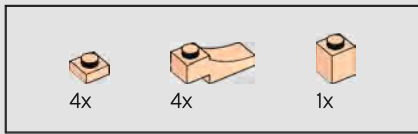

173

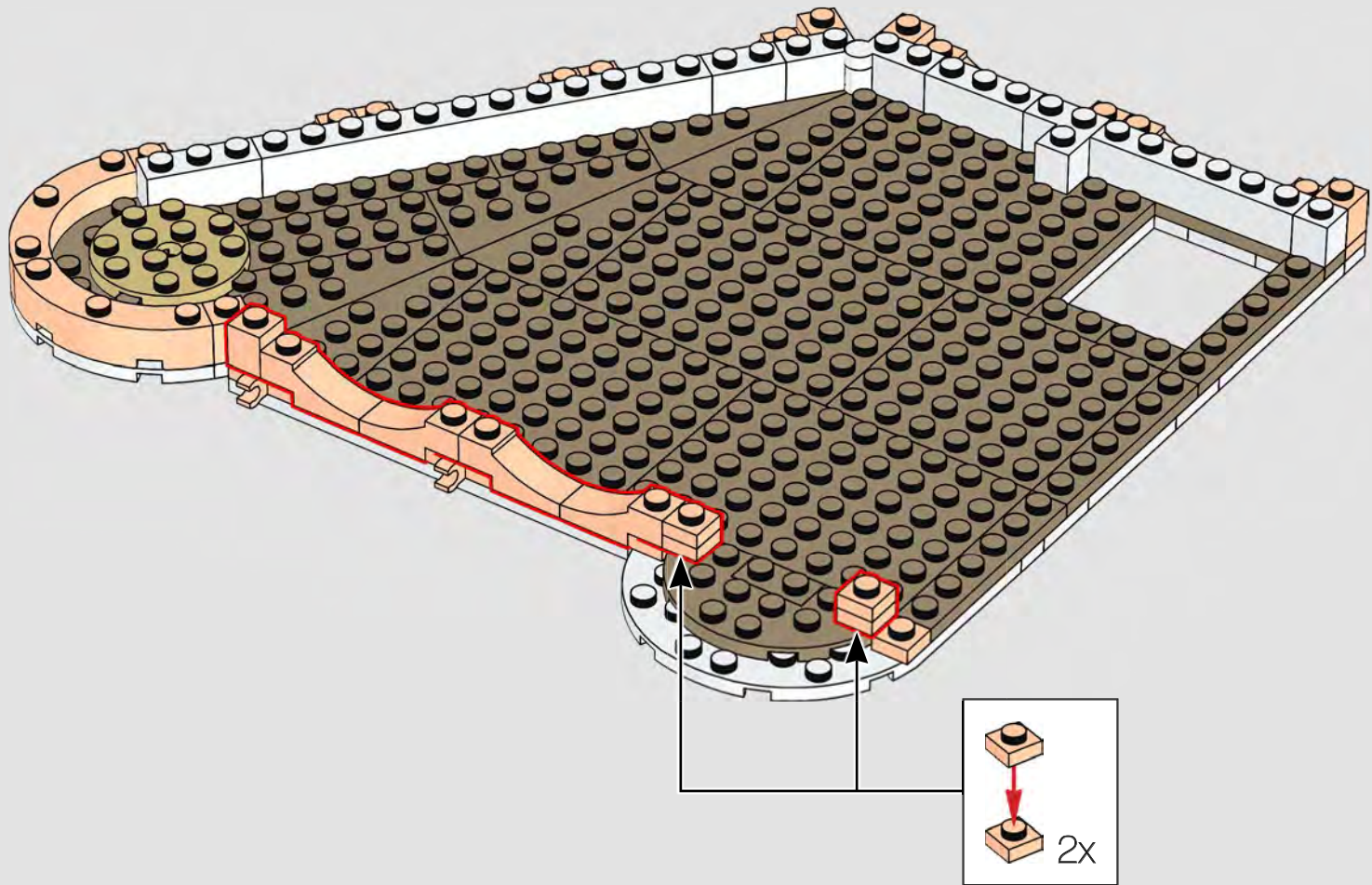

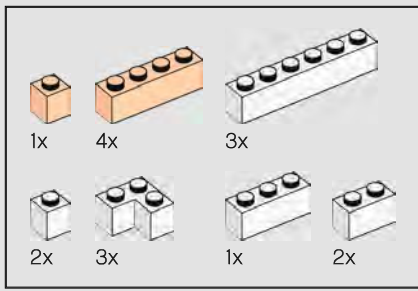

174

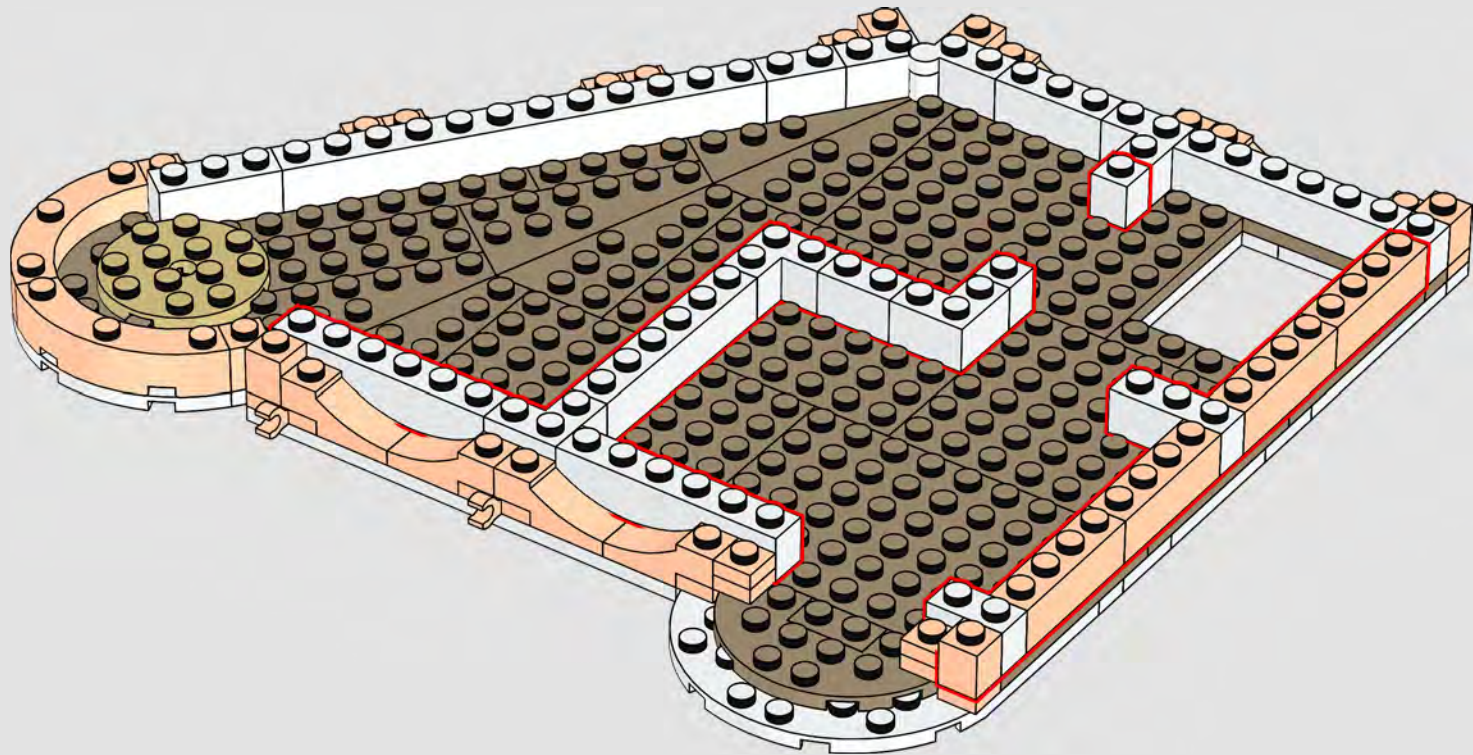

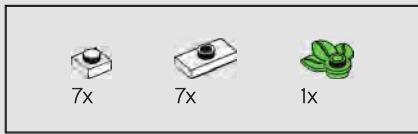

175

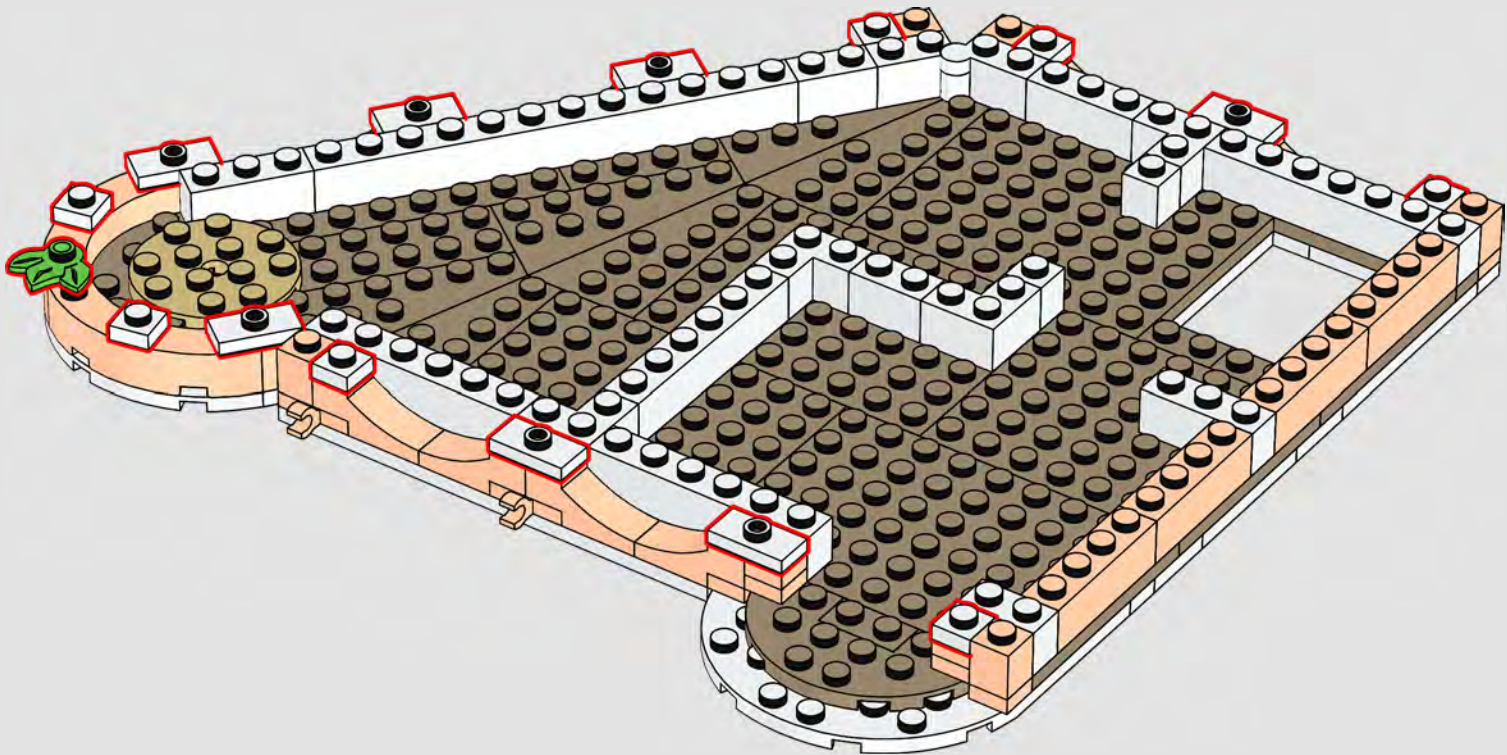



176

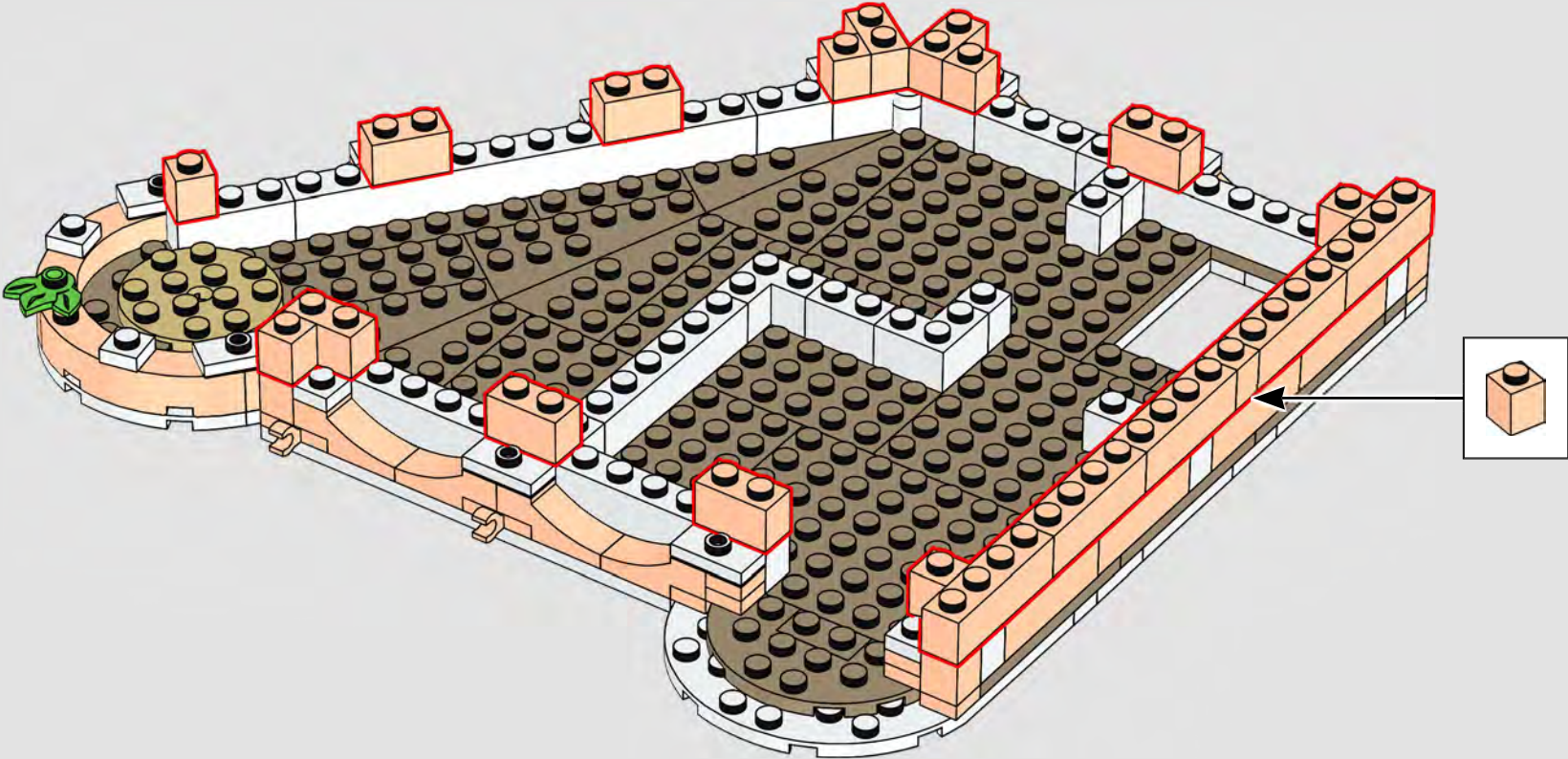

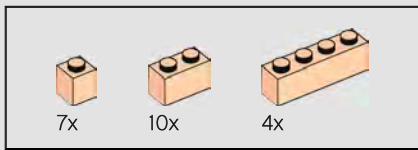

177

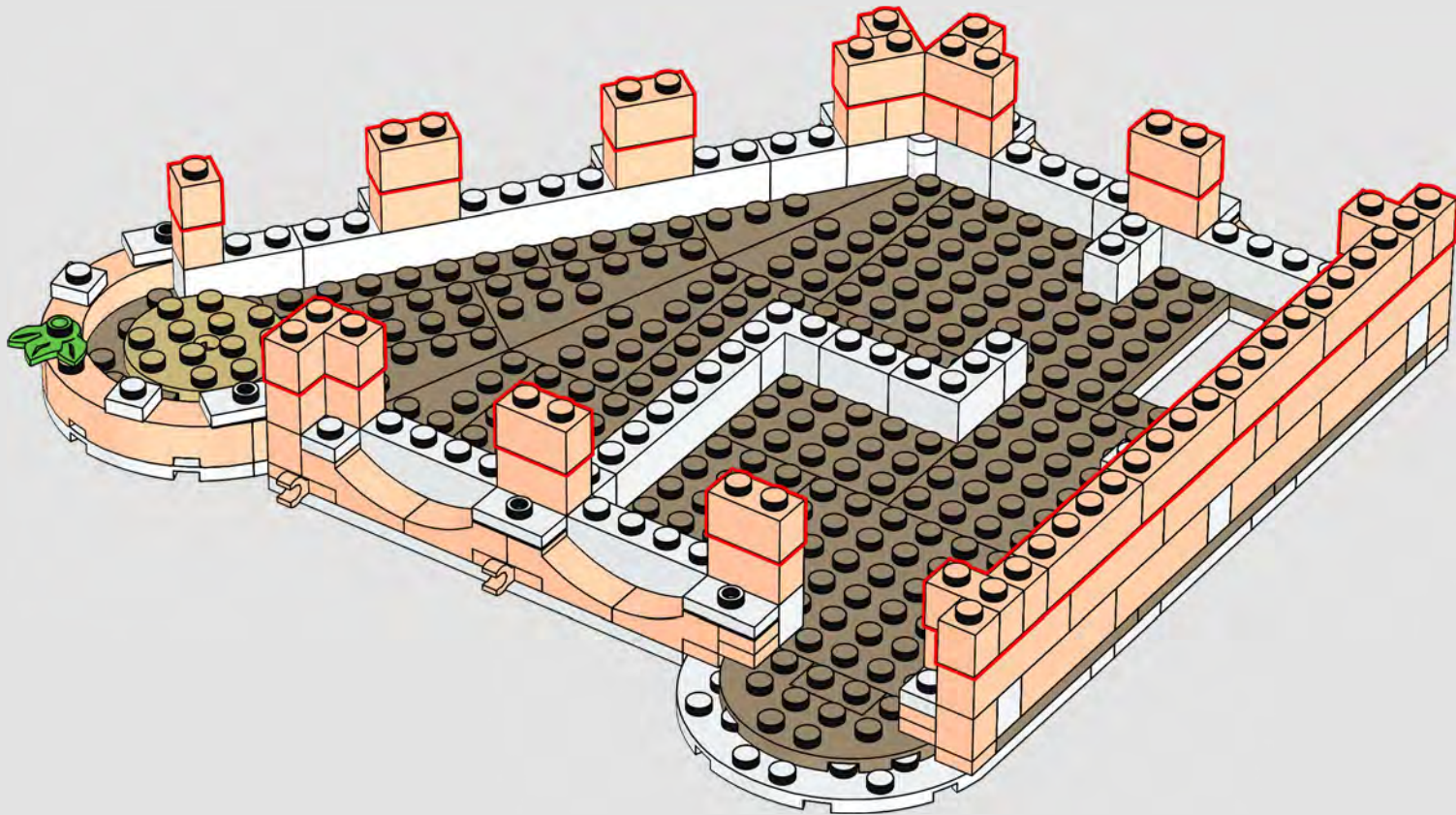

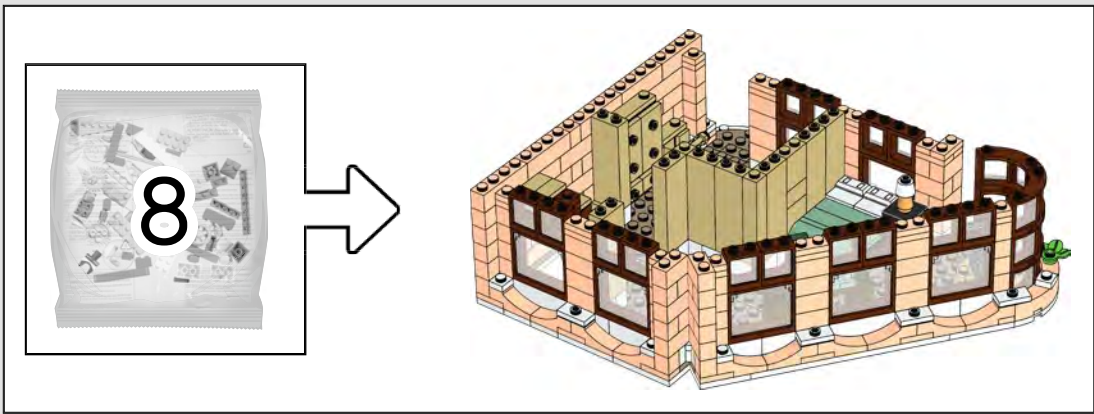

178

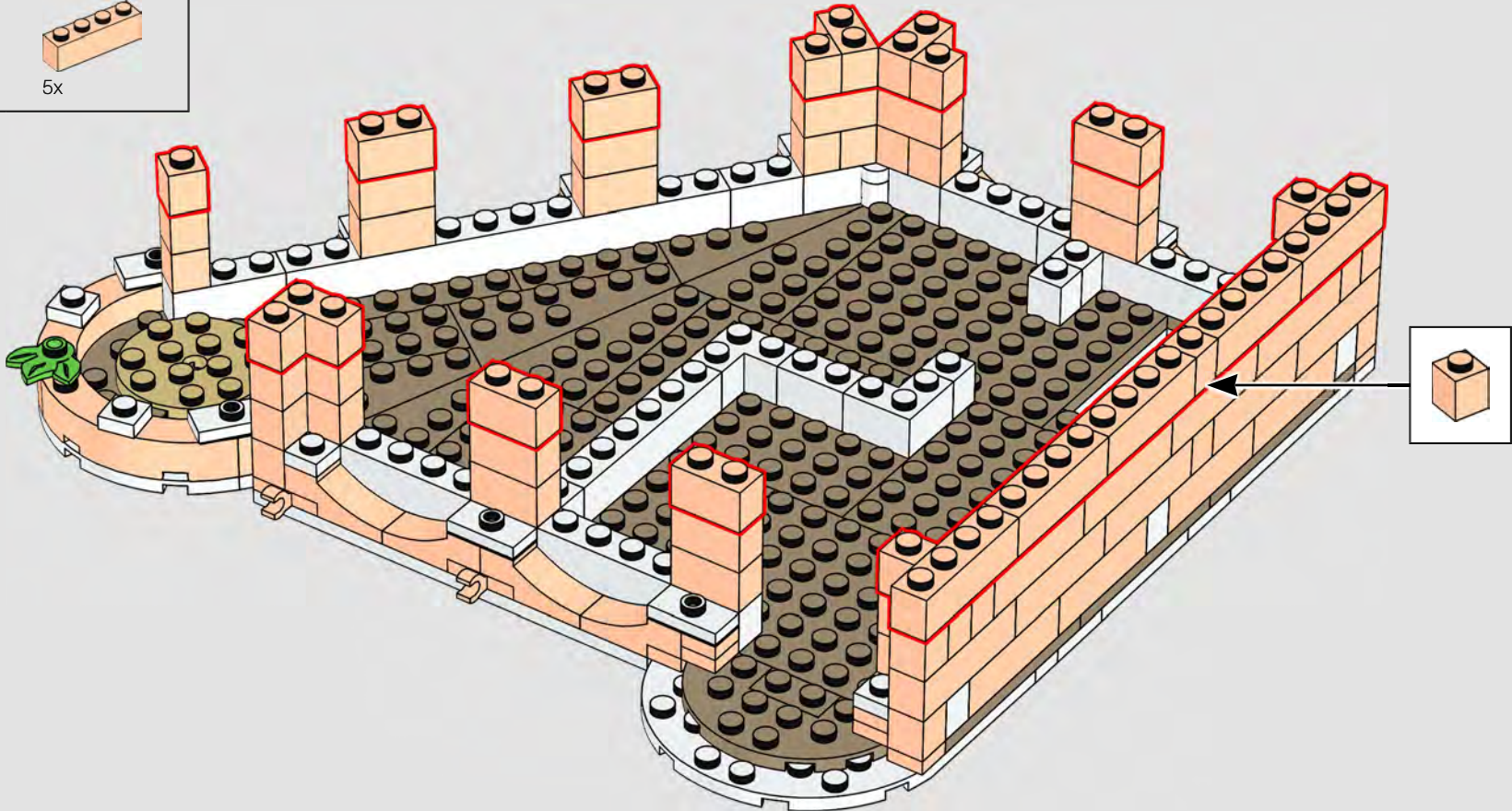

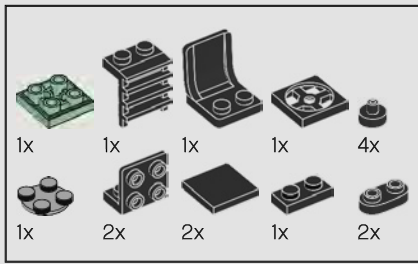

179

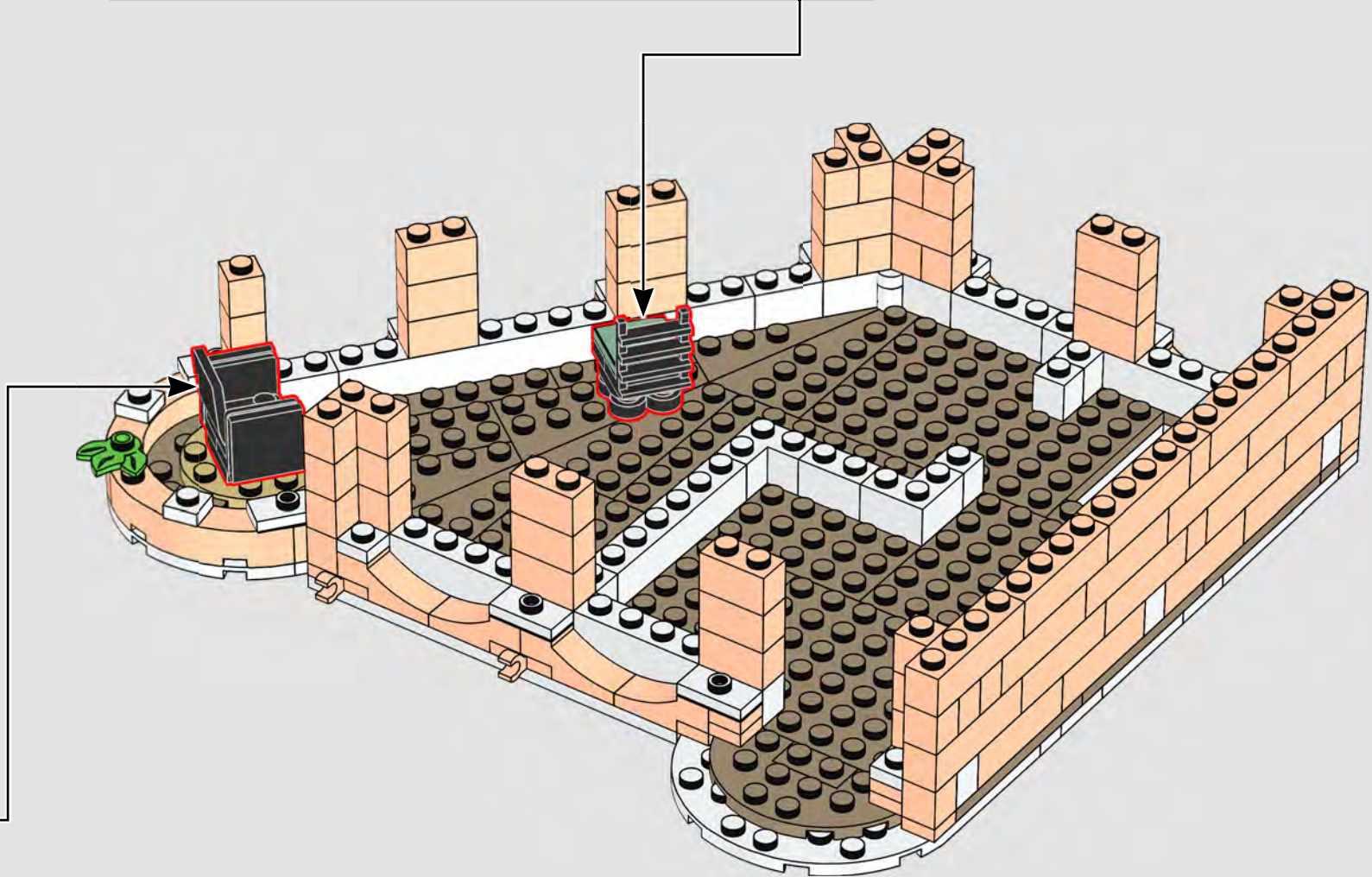
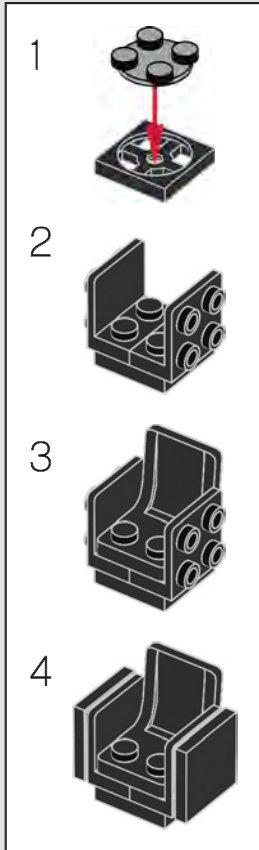
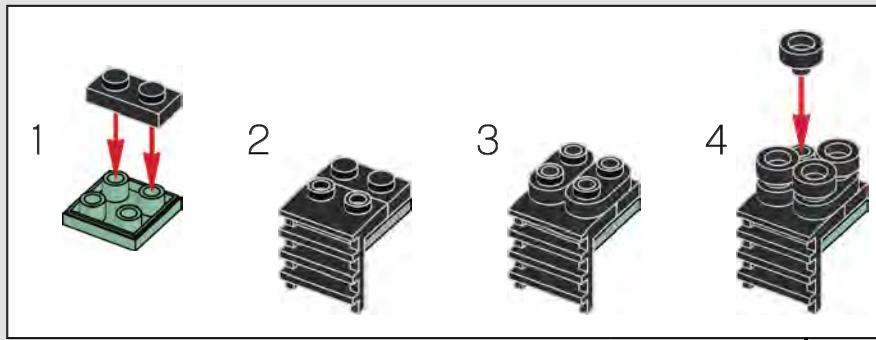

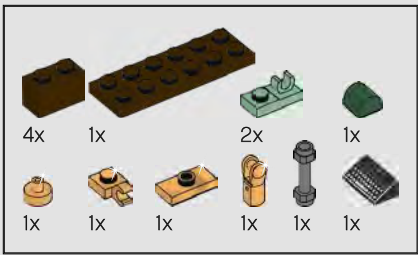

180

1



2

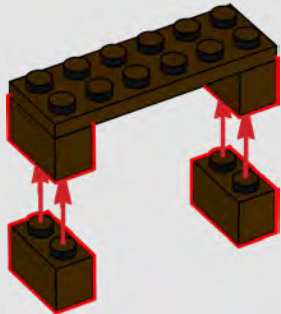

3

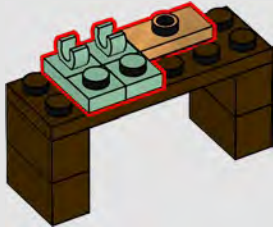

4

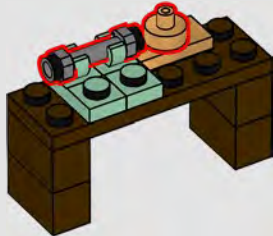

5



6

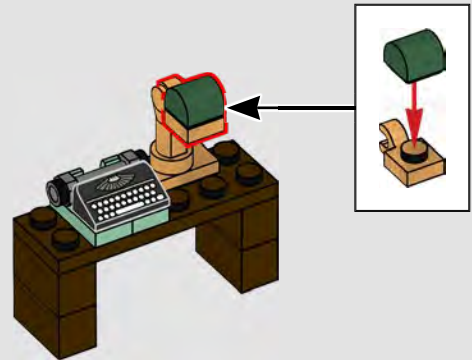

The local typewriter company has recently made sales to both the Hotel and to the 10278 Police Station set.

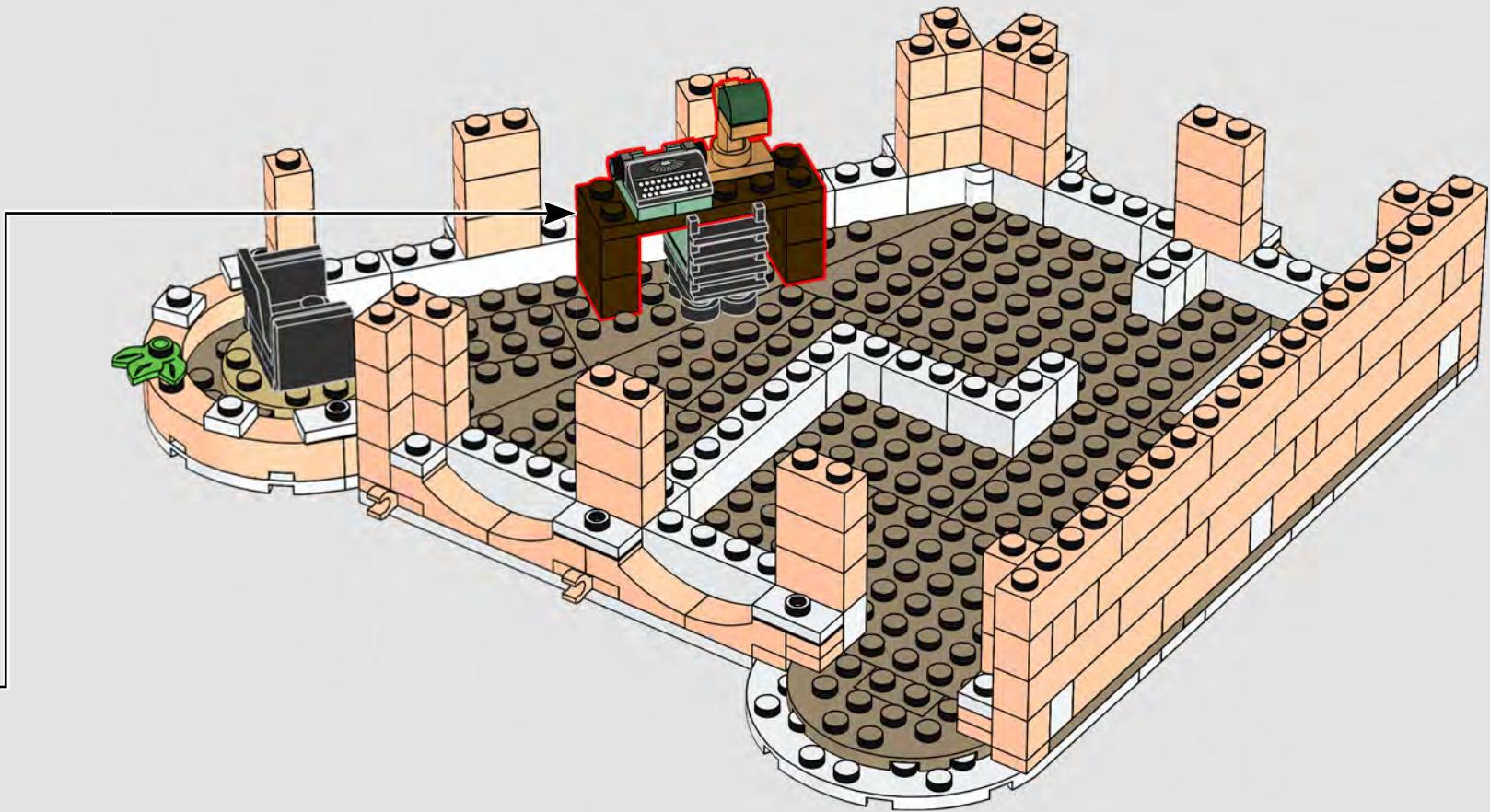

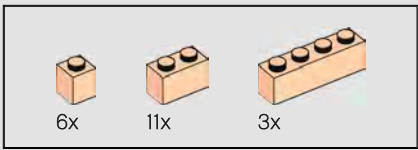

181

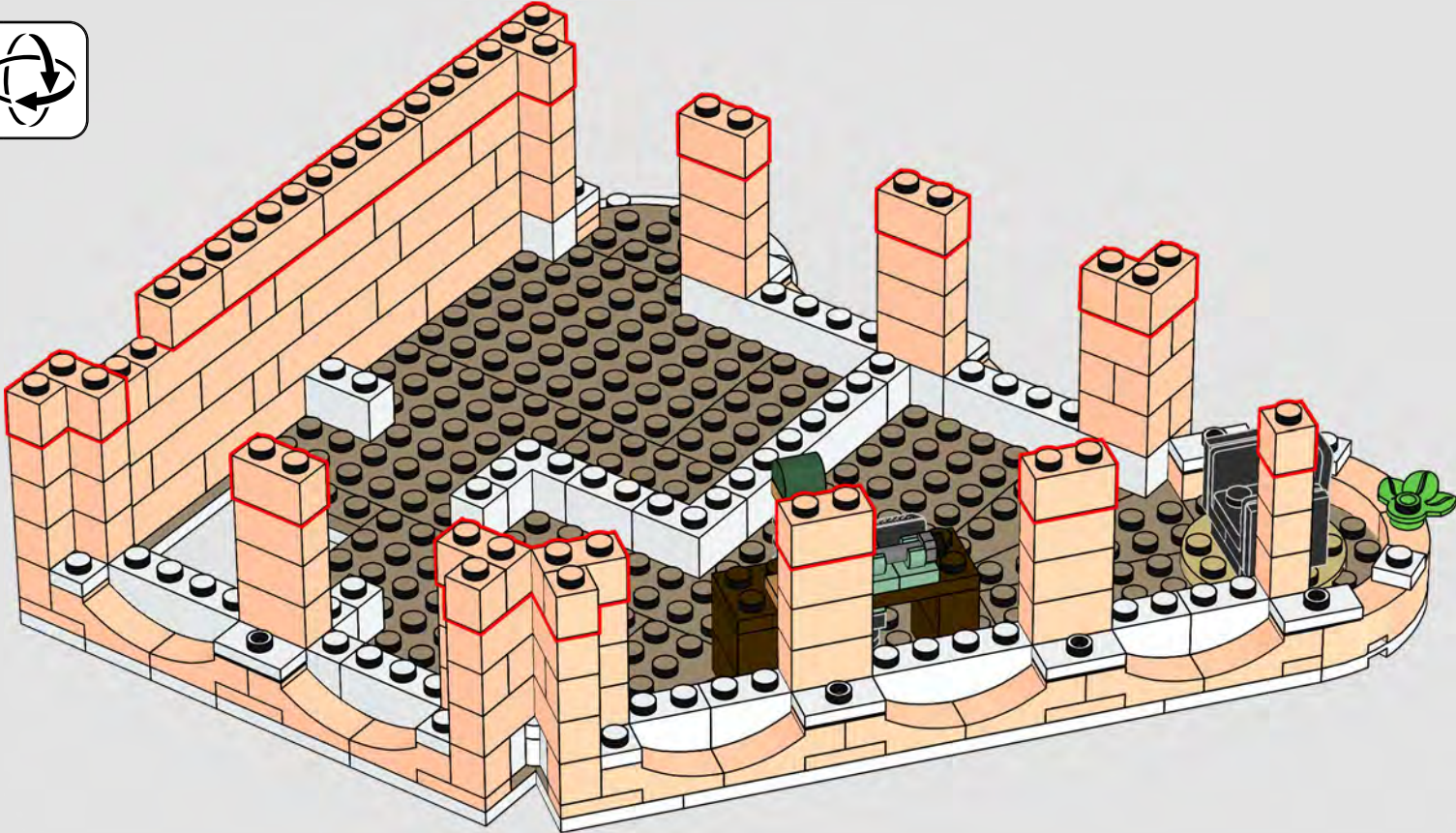



182

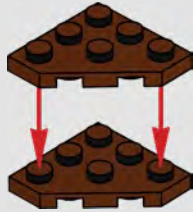

183



184

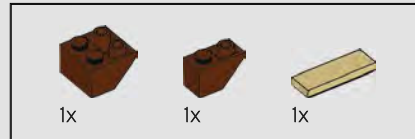
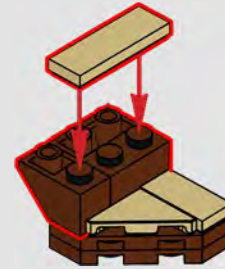

185

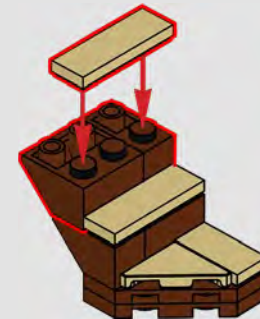

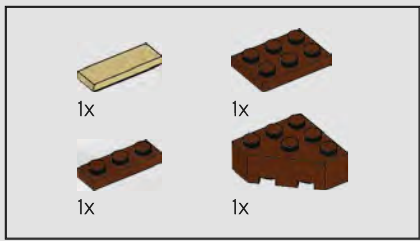

186

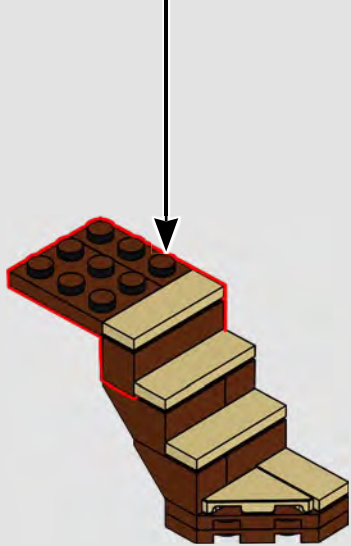
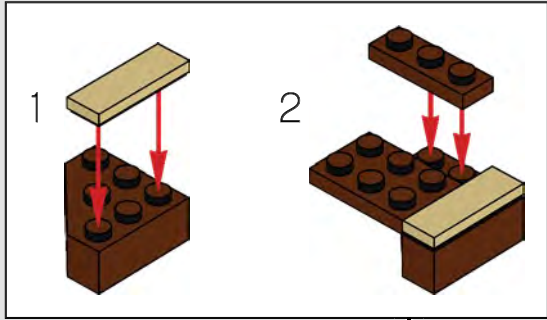

187

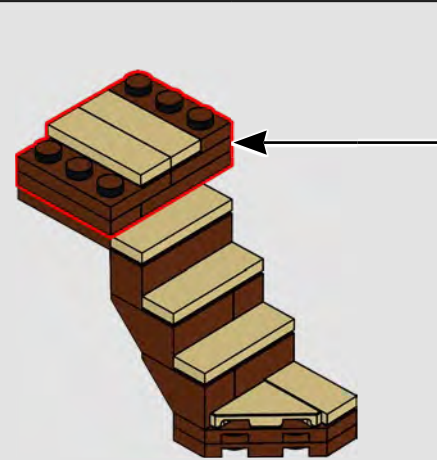
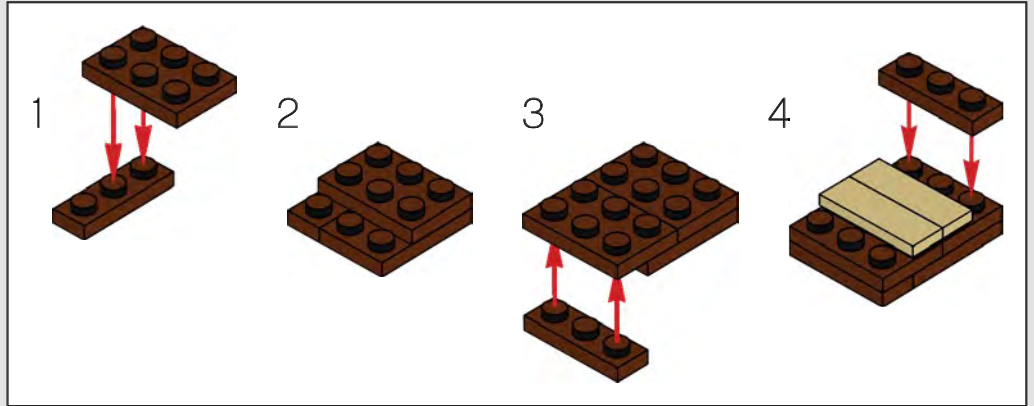

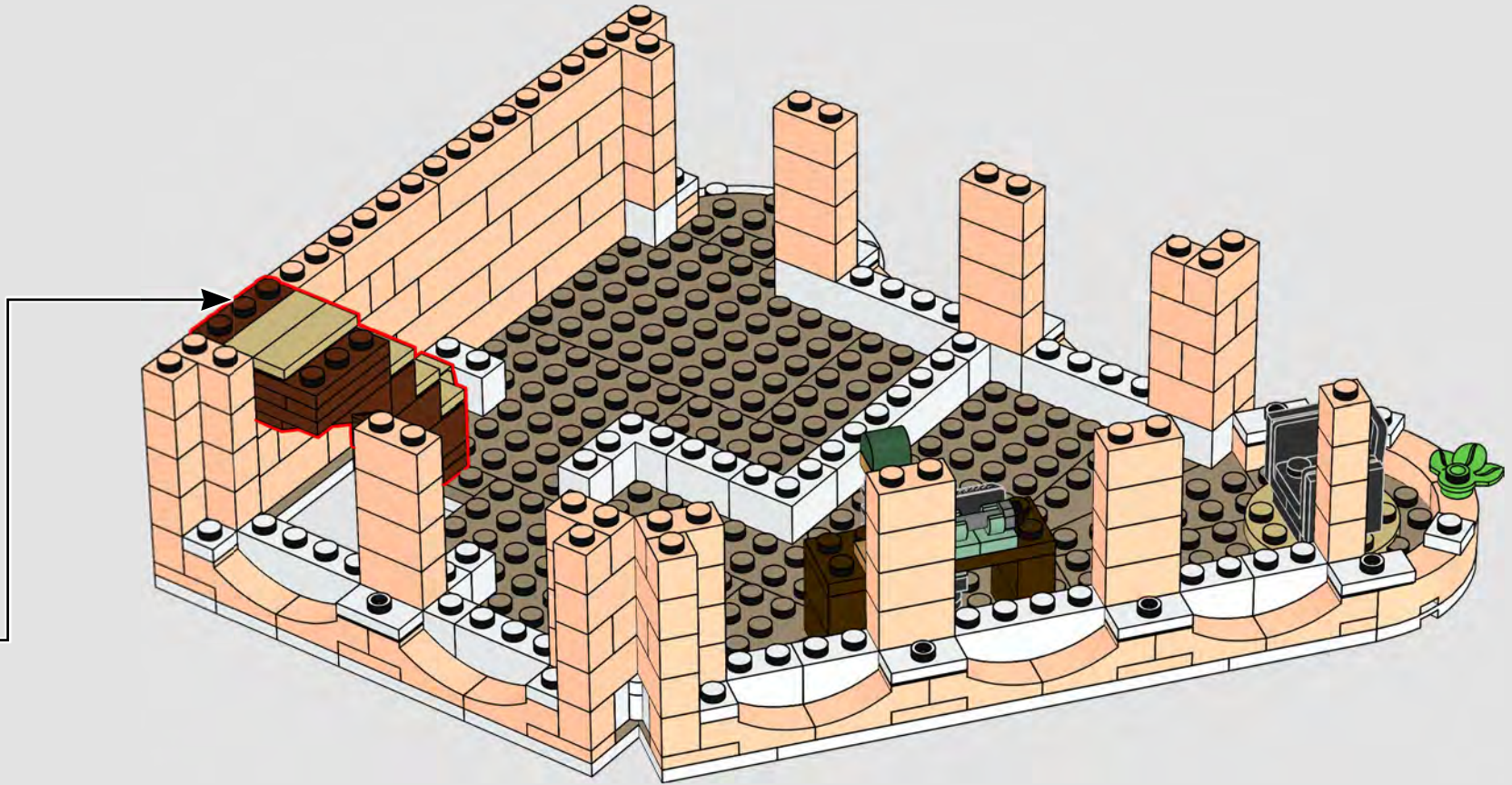

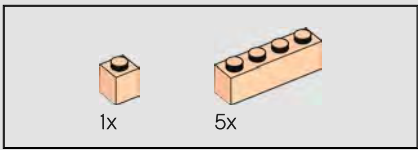

189

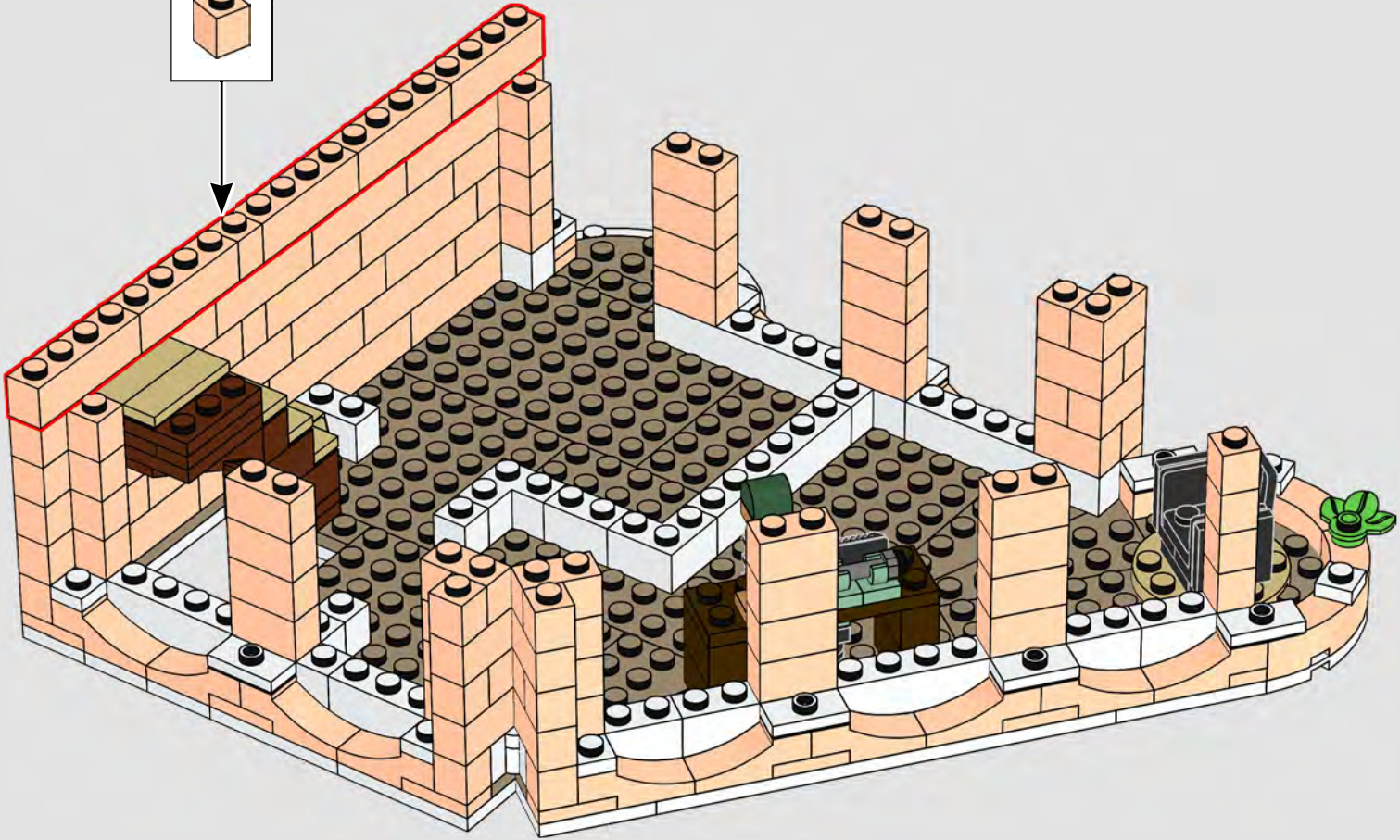
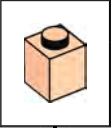

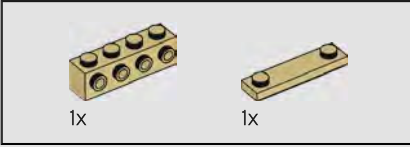
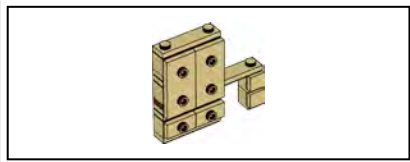

190

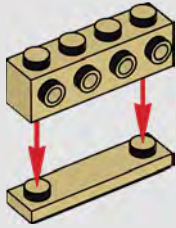

191

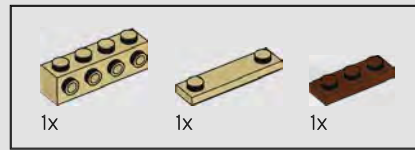
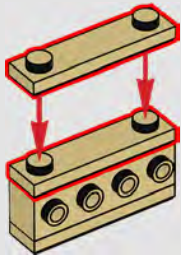

192

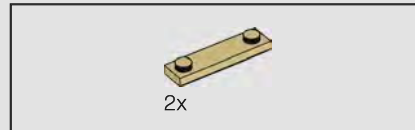
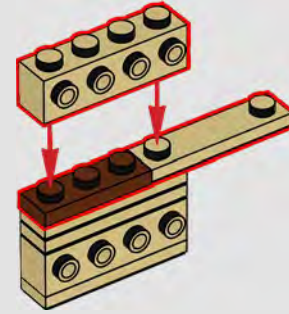

193

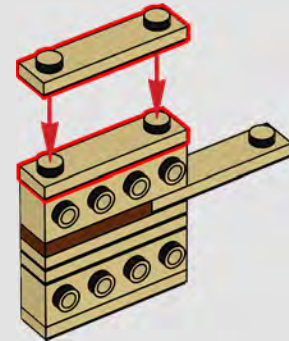

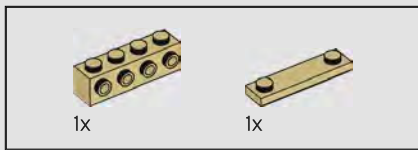

194

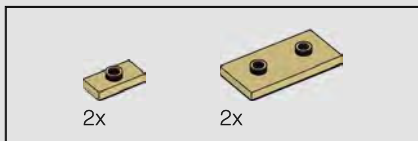
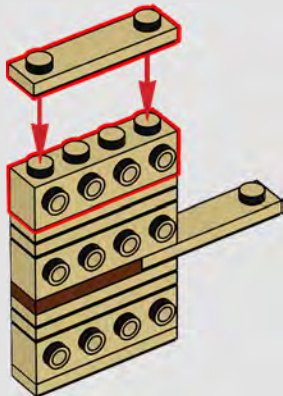

195

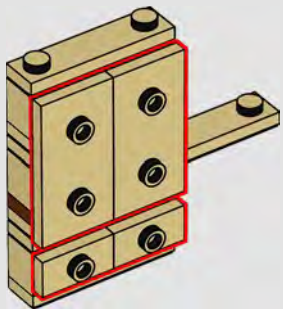

196

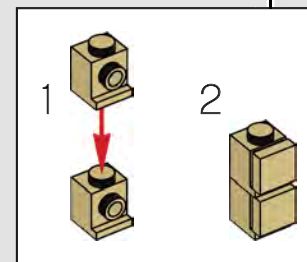
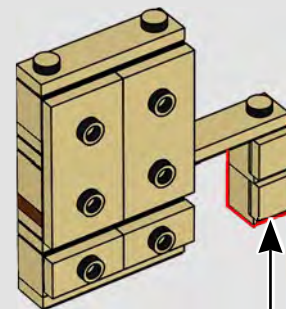

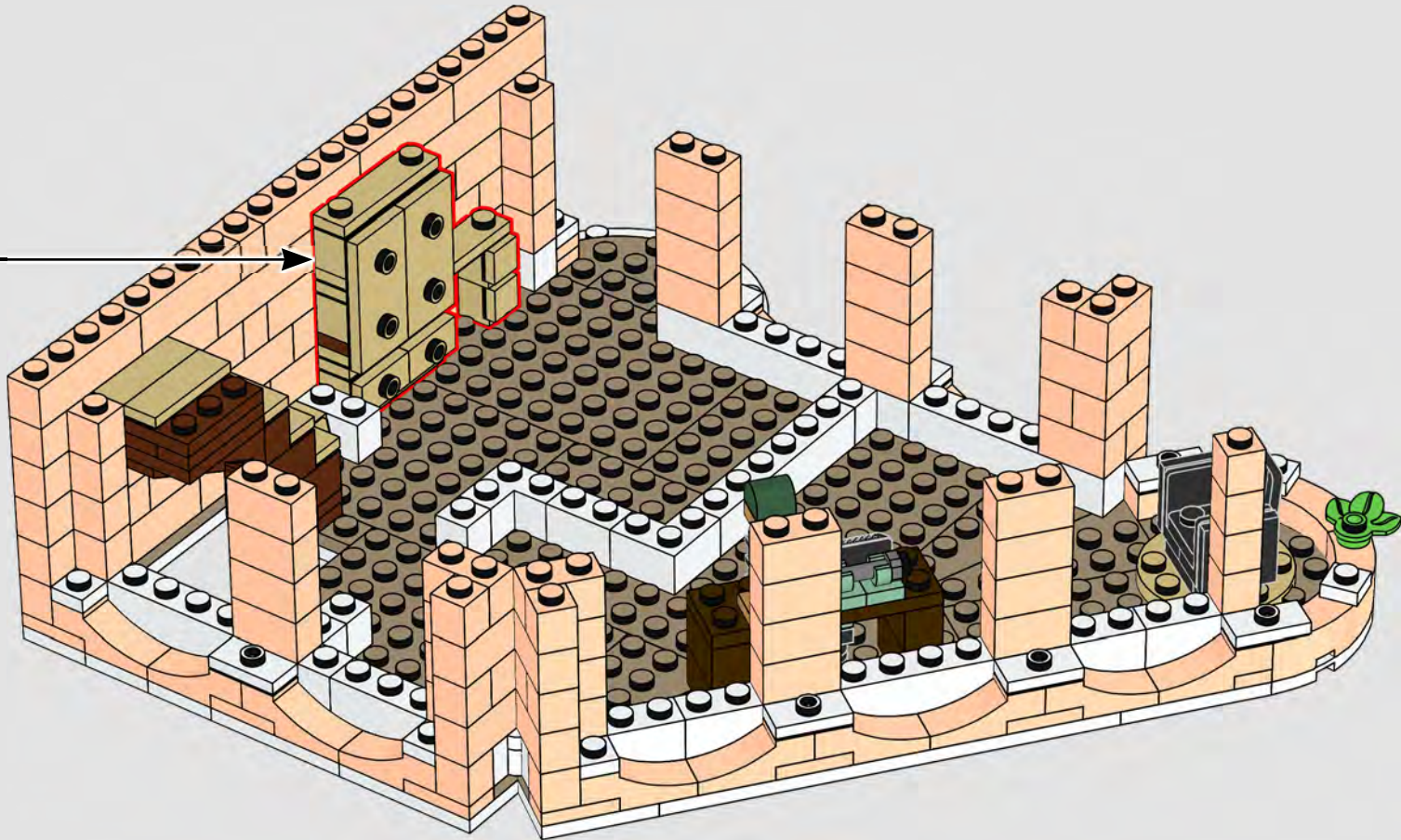

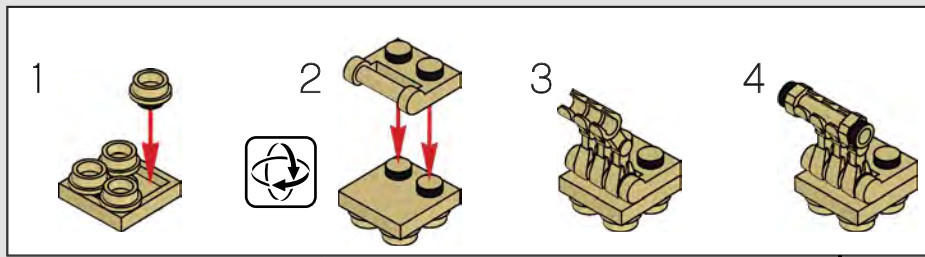
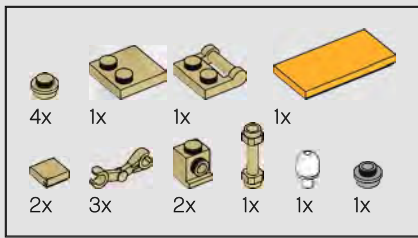

198

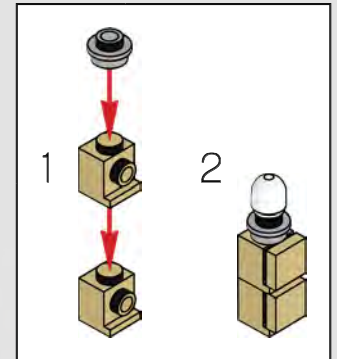
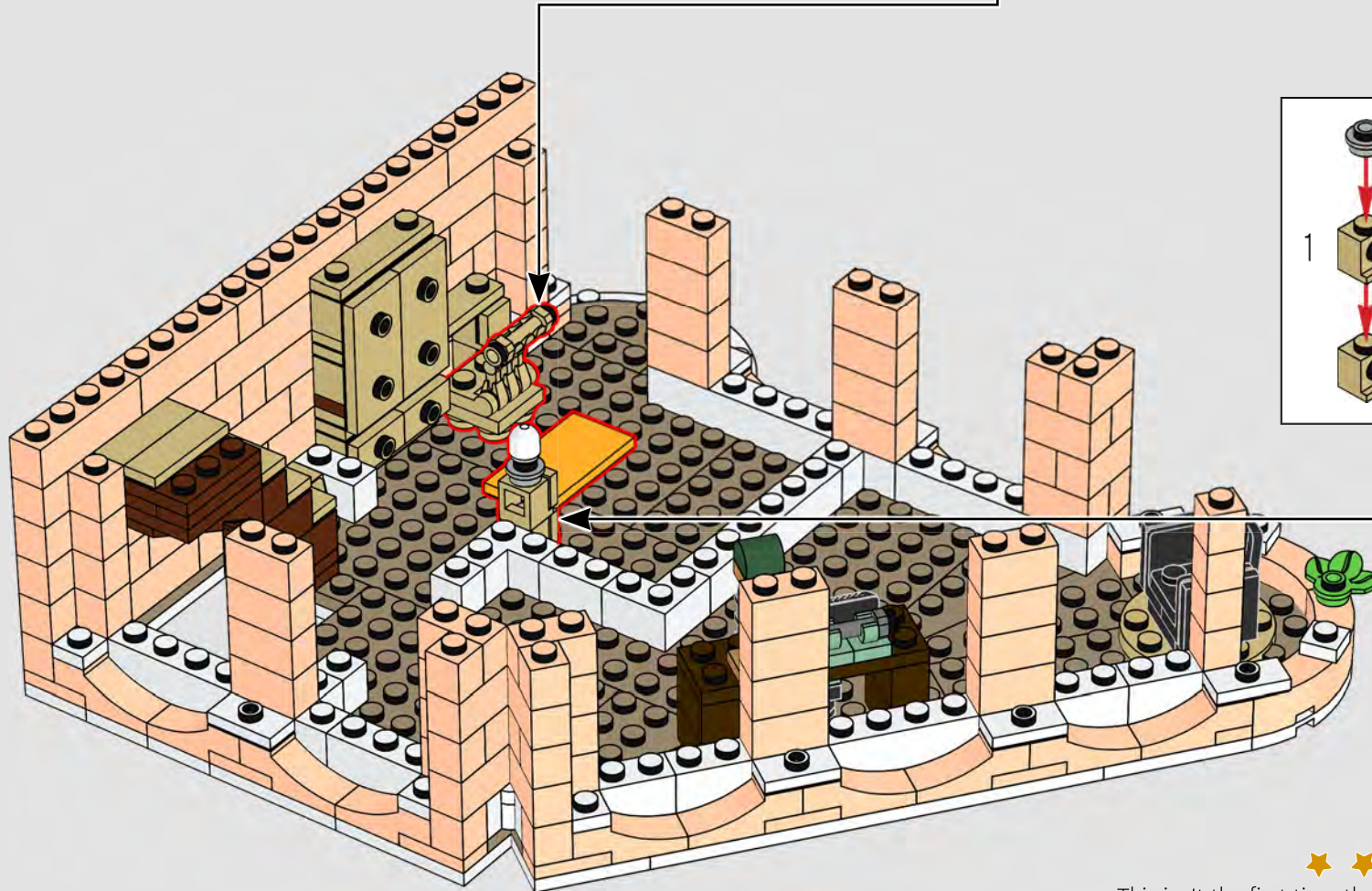

This isn't the first time these robot arms have been used in a modular model... you can also find them forming the railing of the balcony in the 10190 Market Street set.

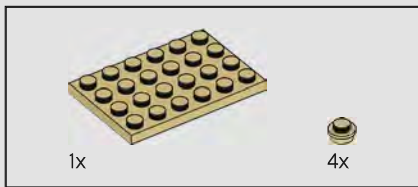

199

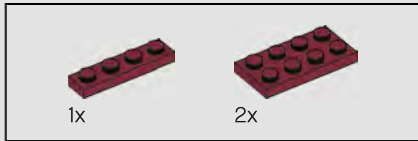
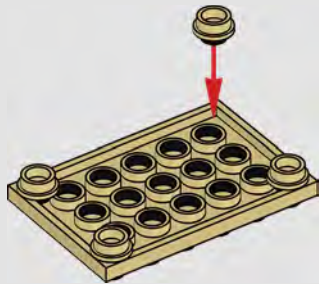

200

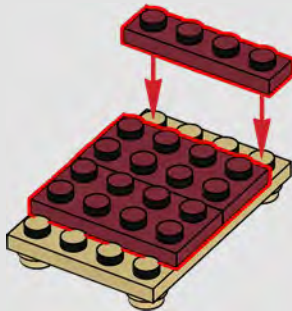

201

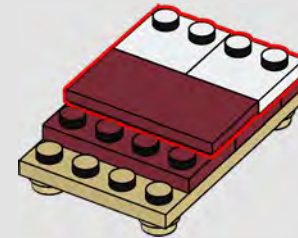

202

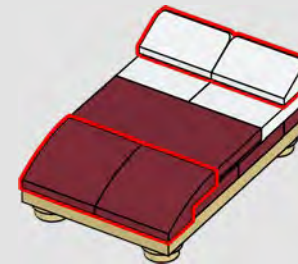

203

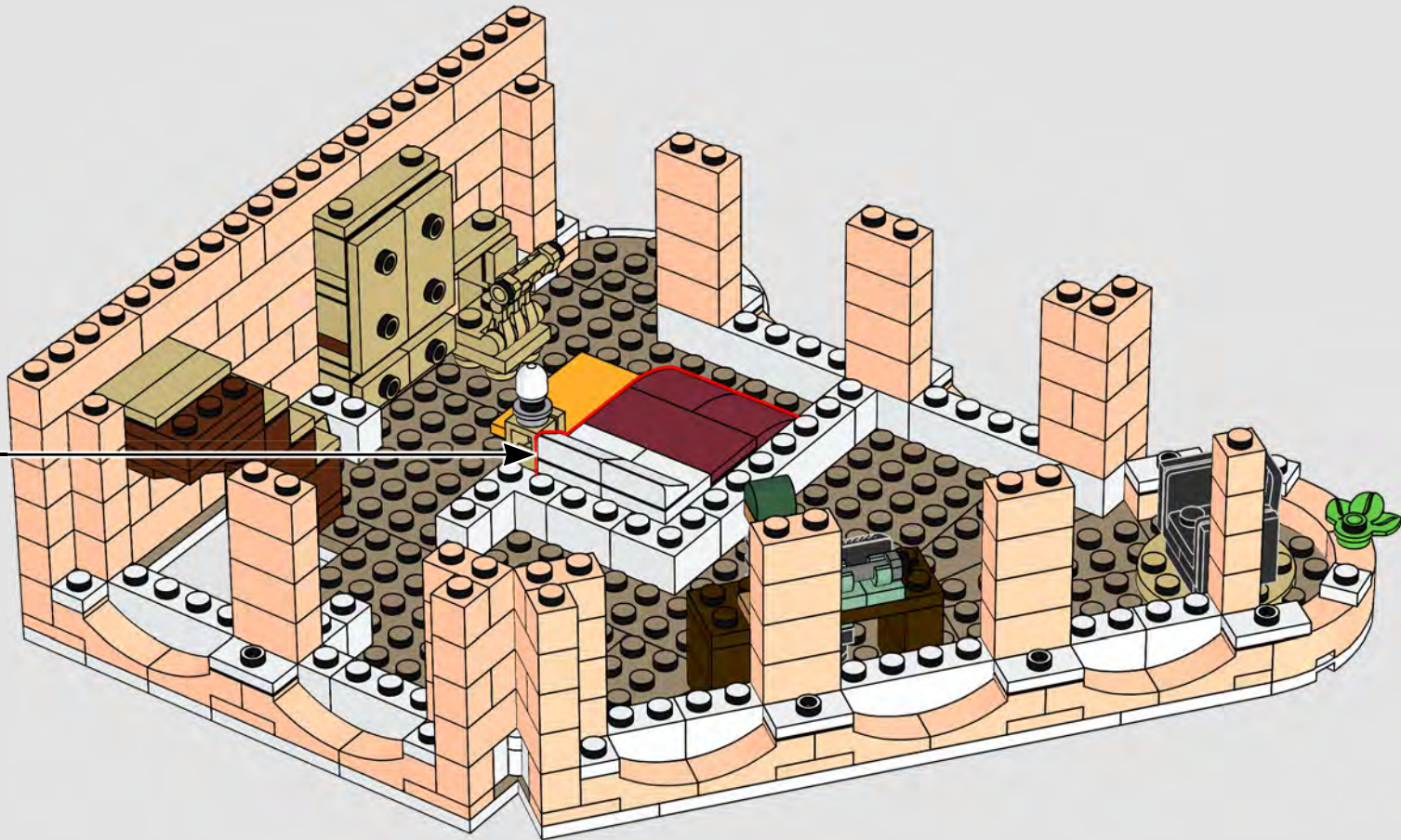

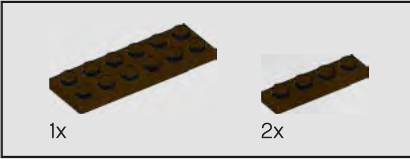
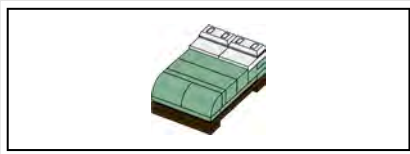

204

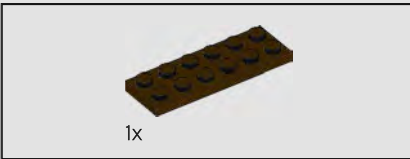
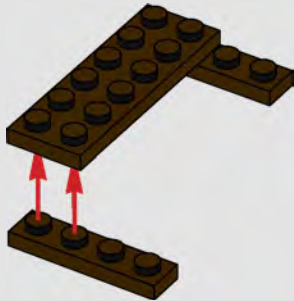

205

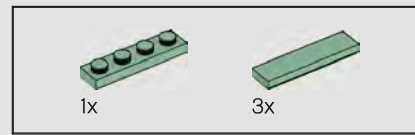
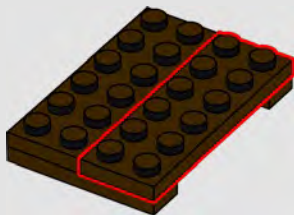

206

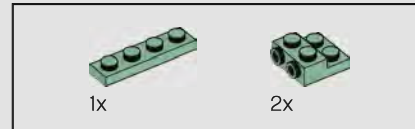
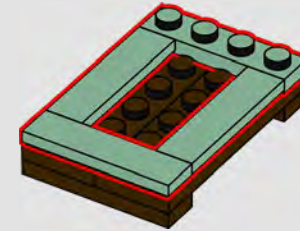

207

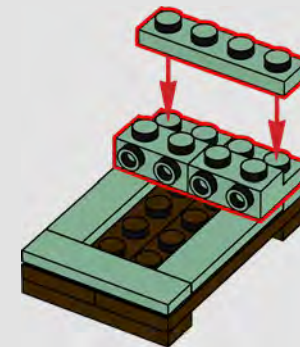

211

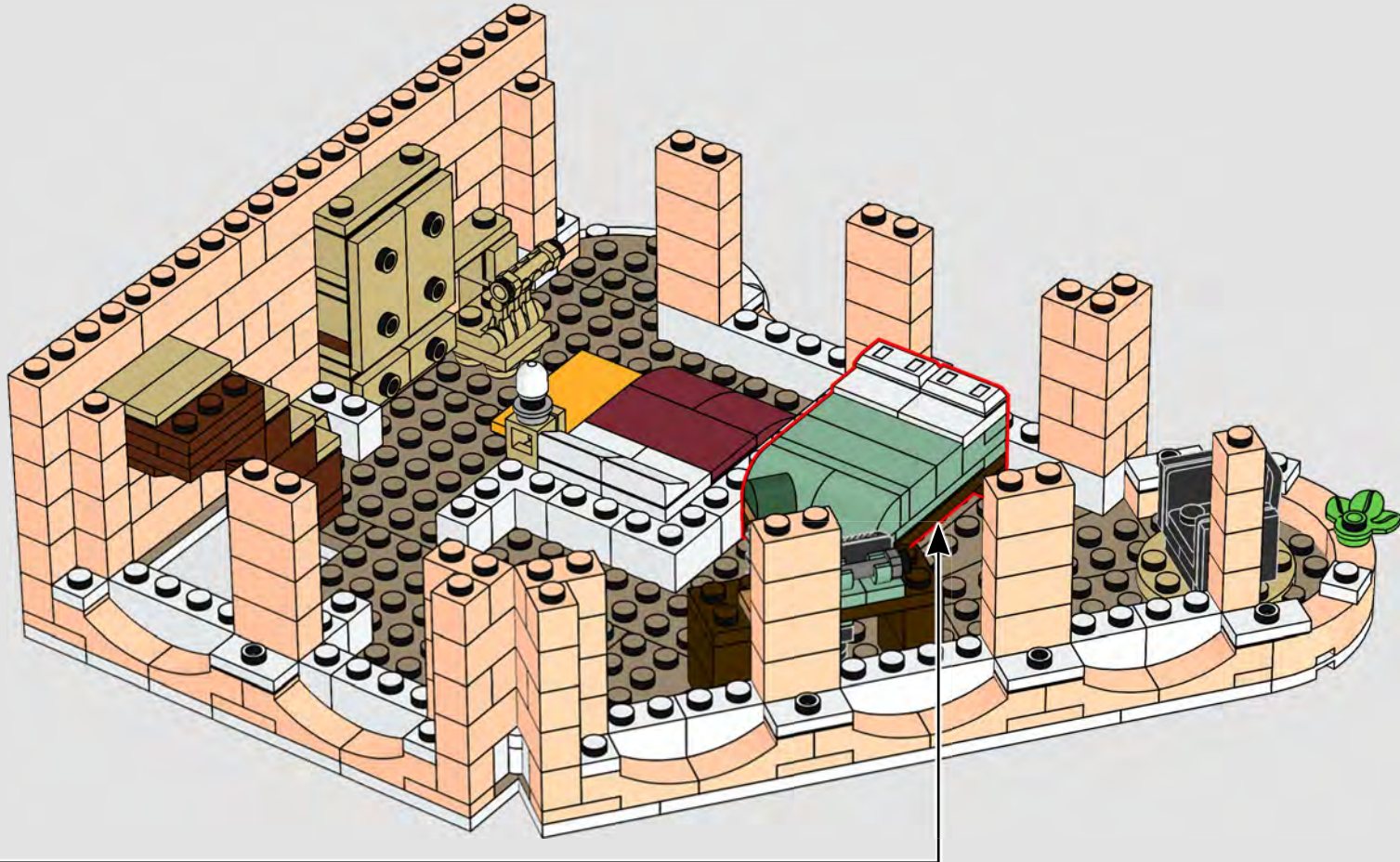

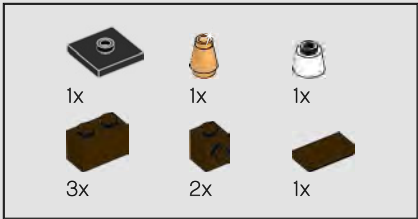

212

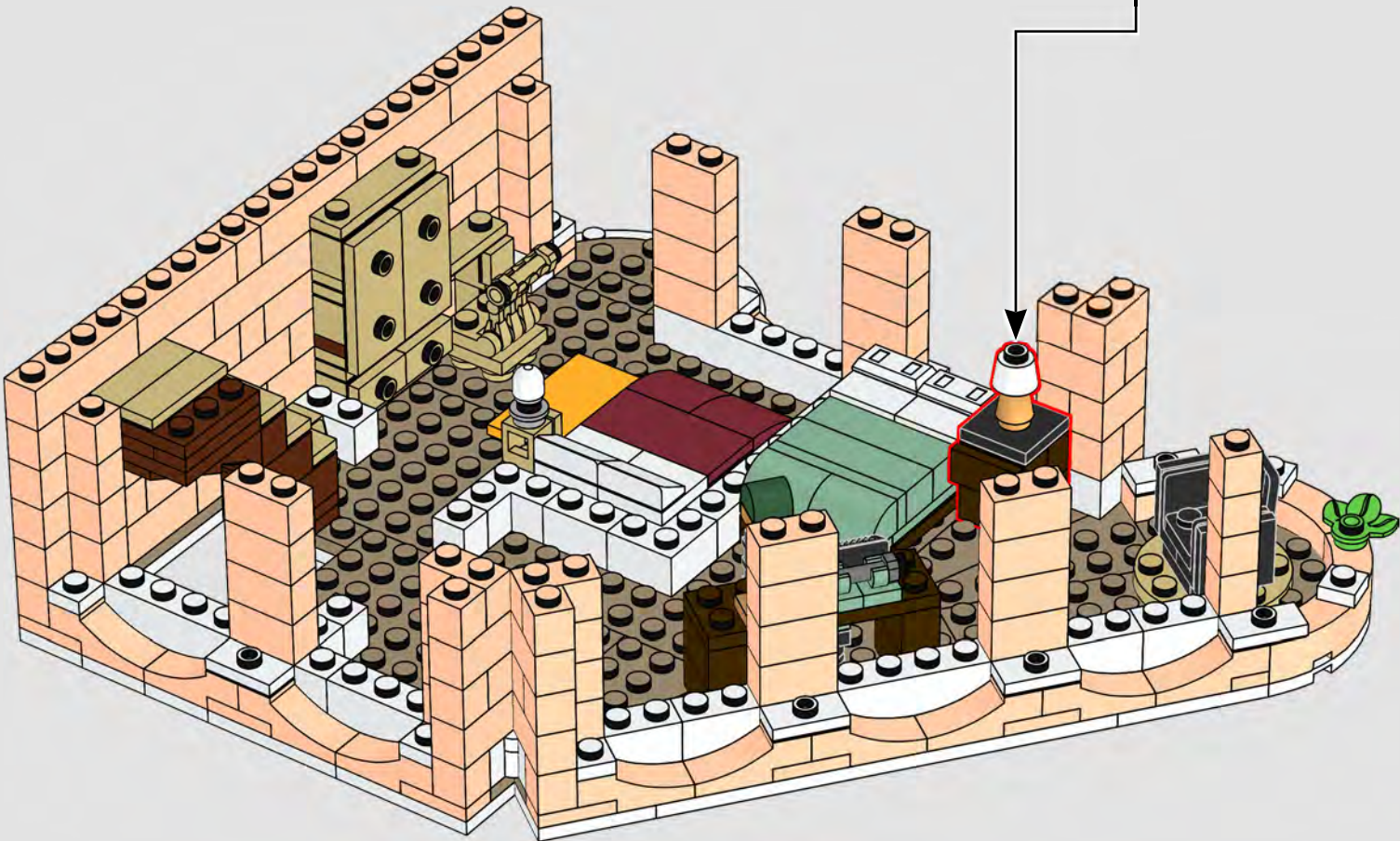
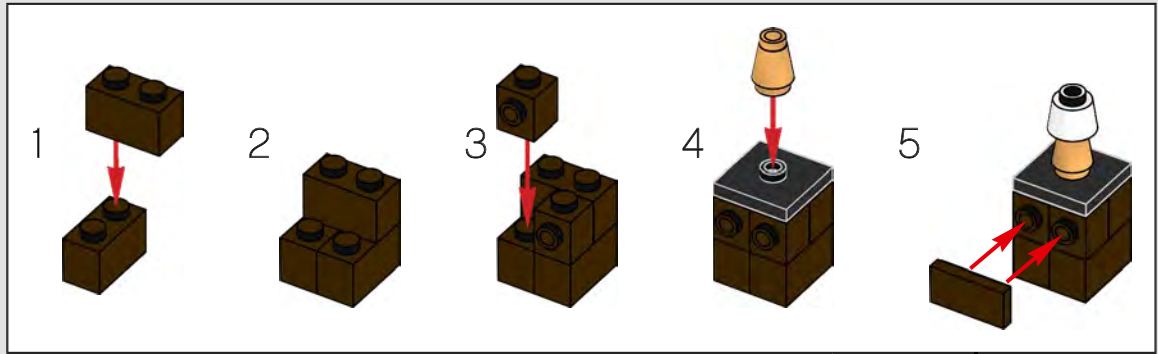

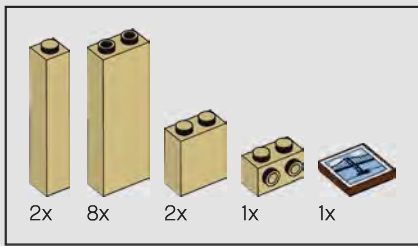

213

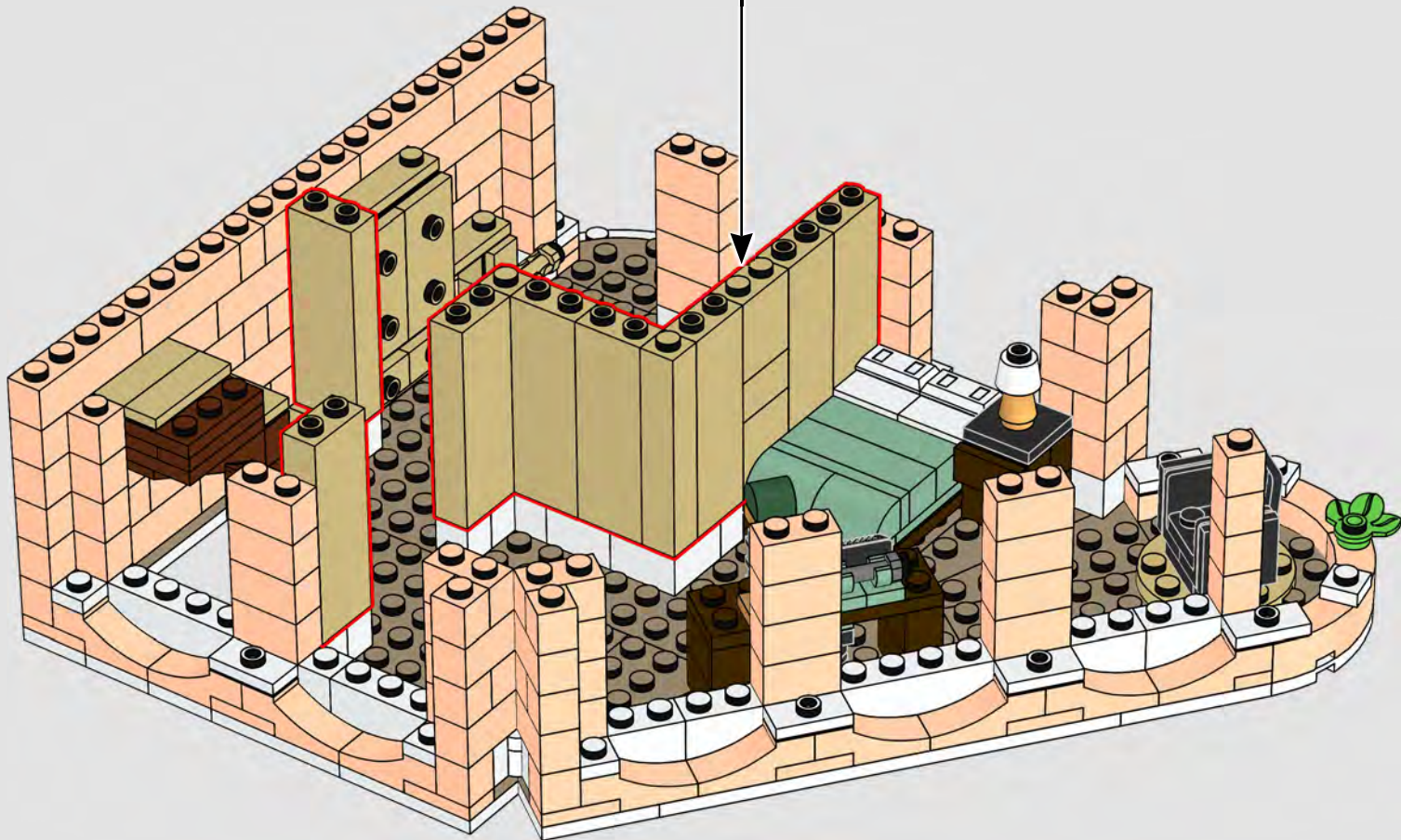
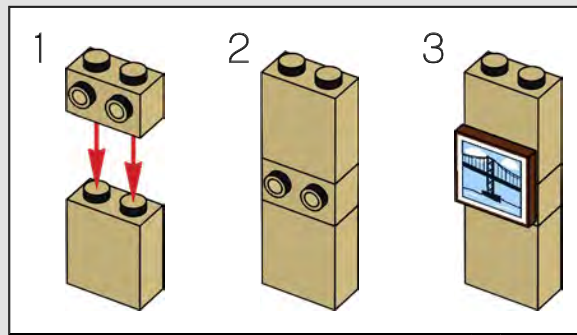

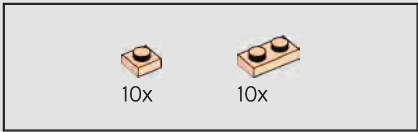

214

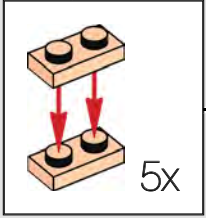
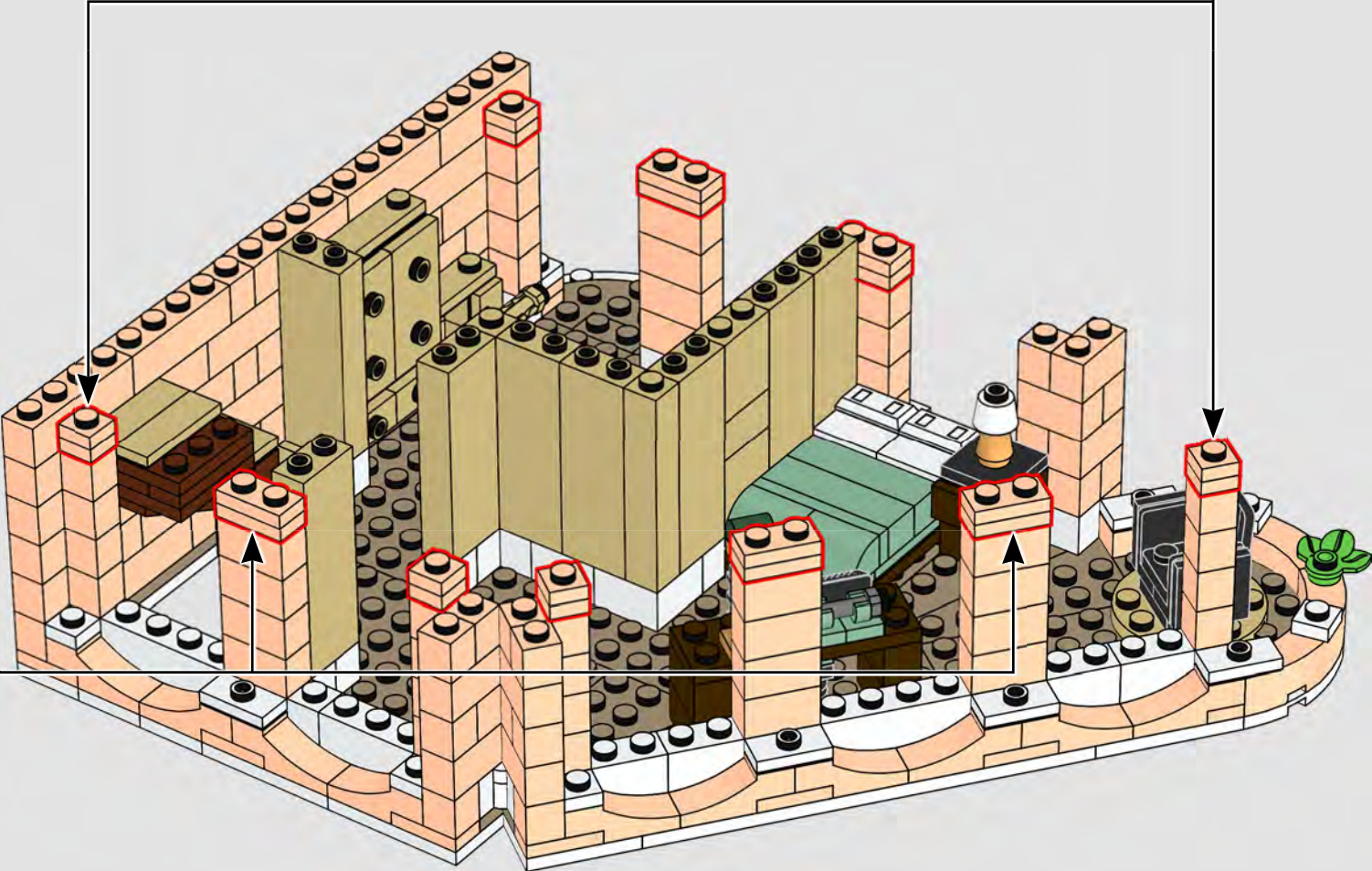
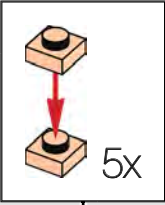



215

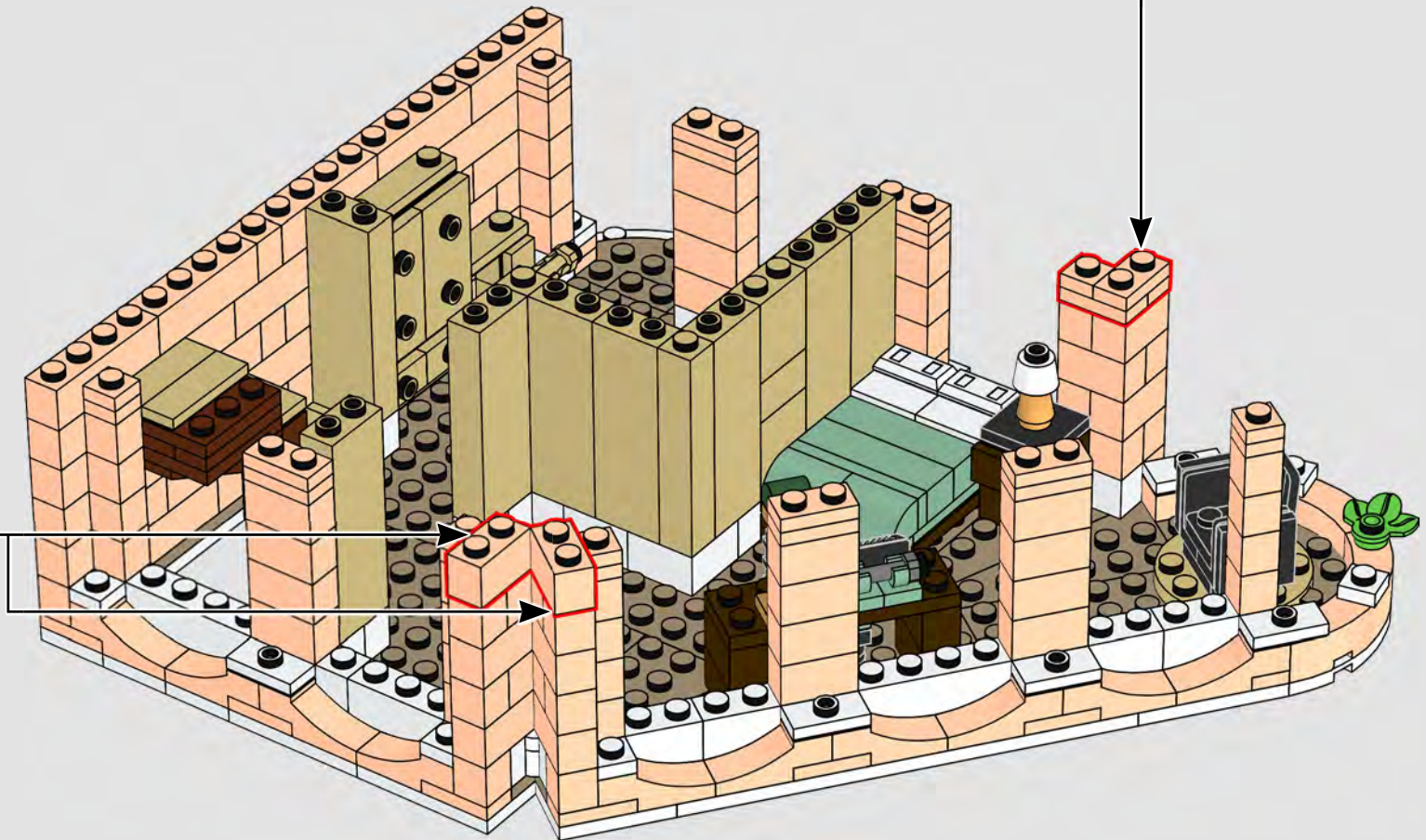
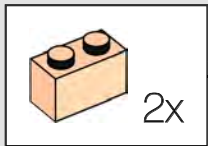
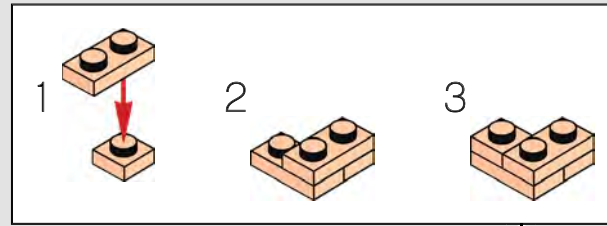

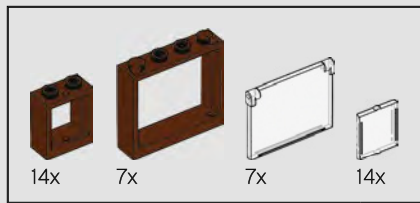

216

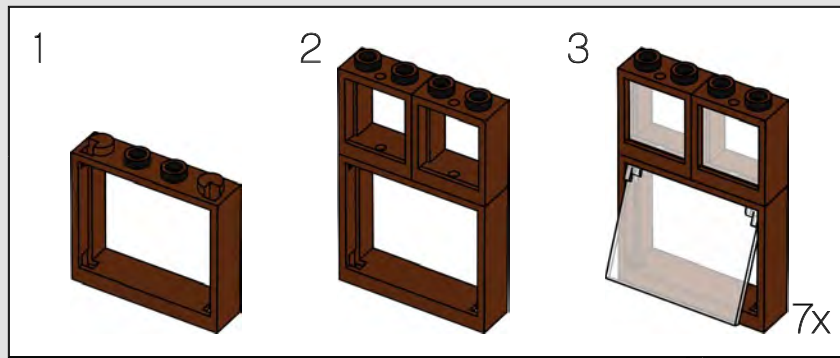

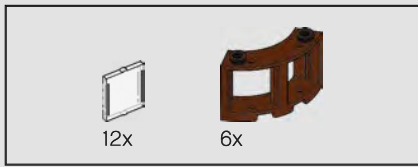

217

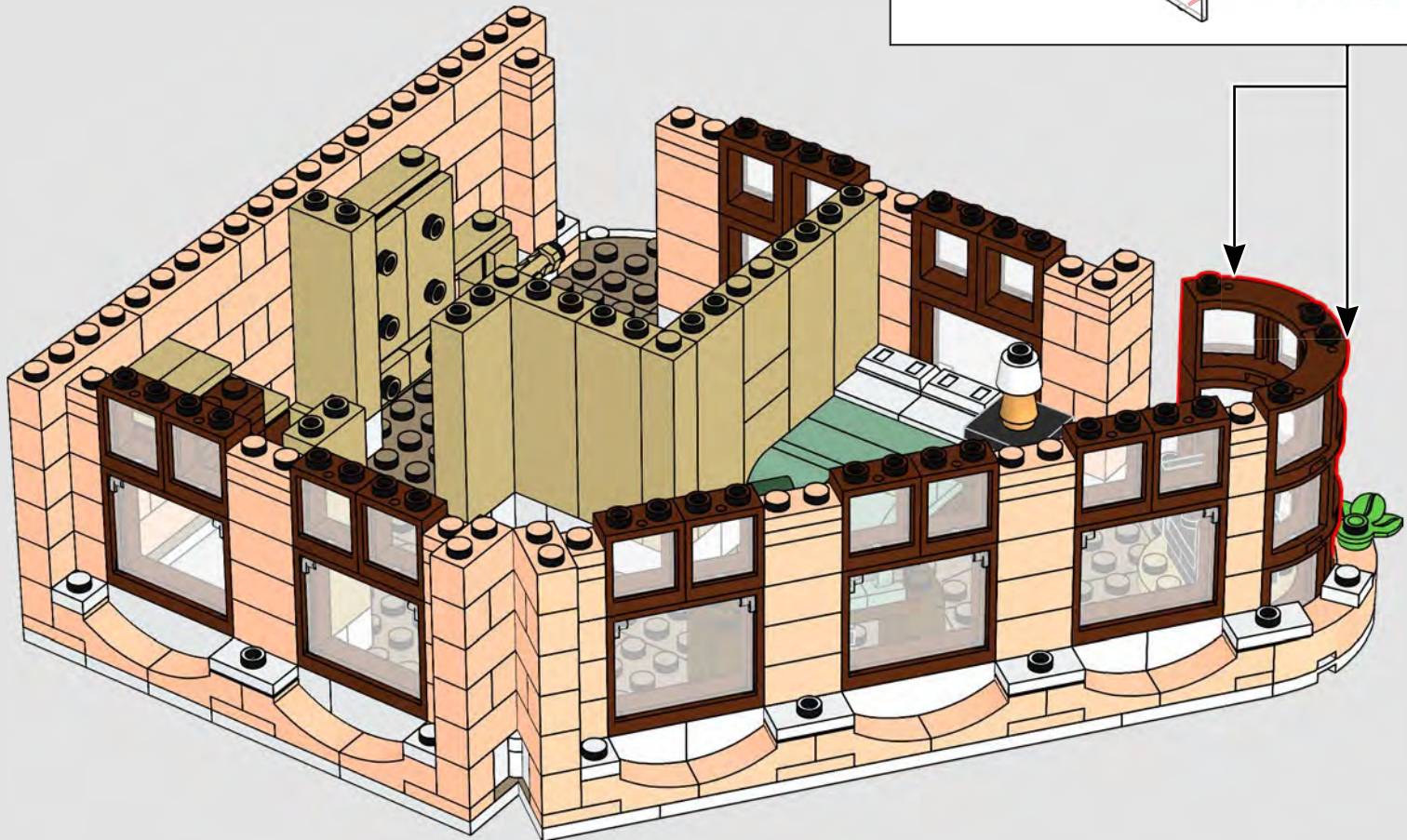
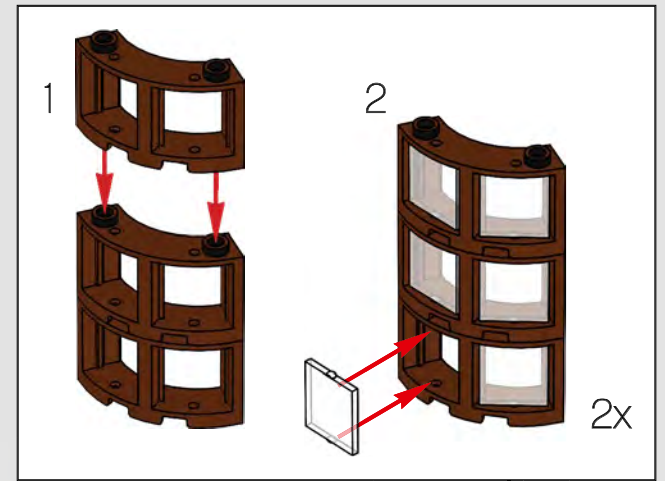

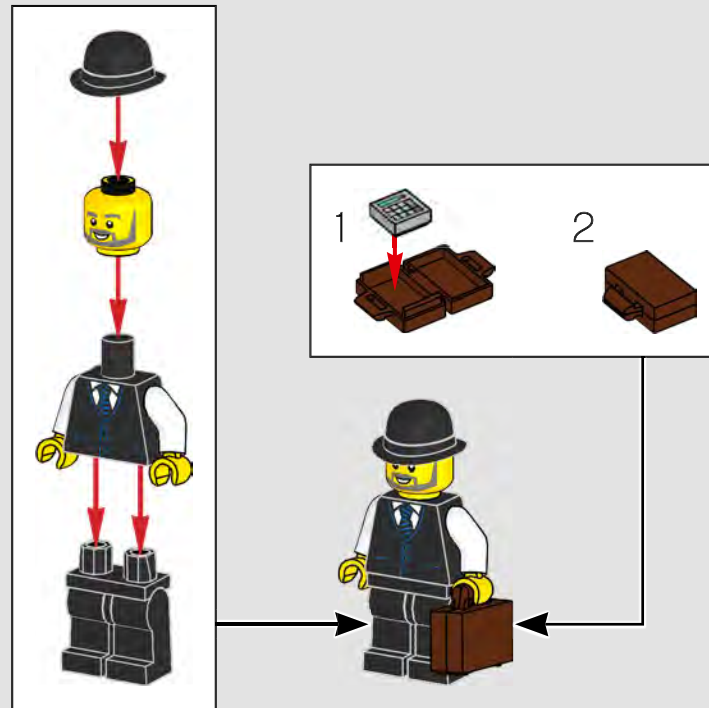
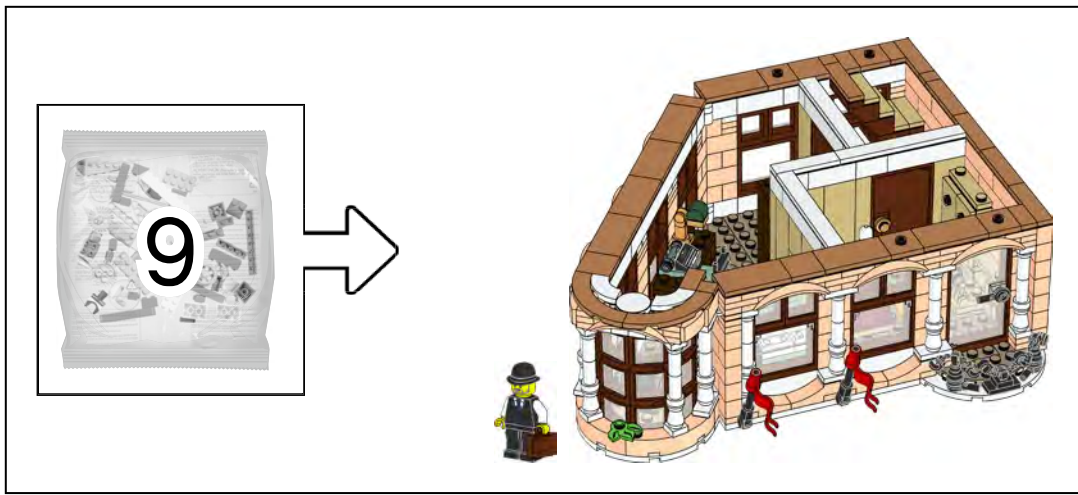

The Accountant is in town to assist with the sale of the Art Gallery's masterpieces. However, he's also been asked to audit the accounts from the 10251 Brick Bank set.

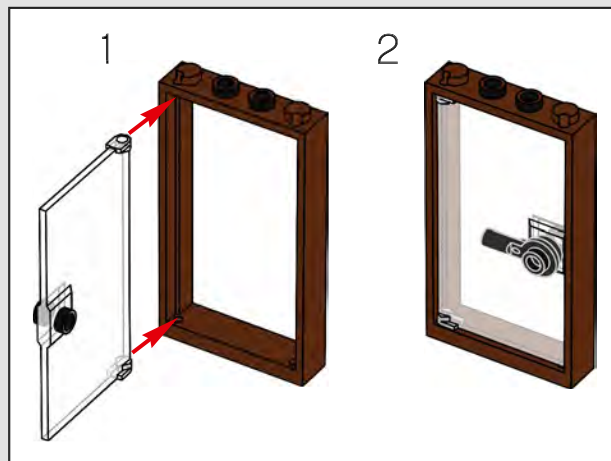
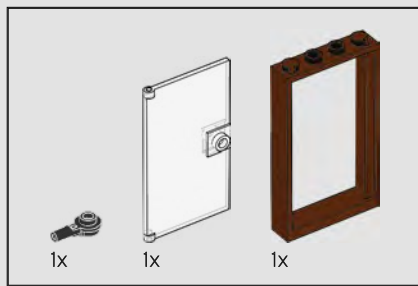

218

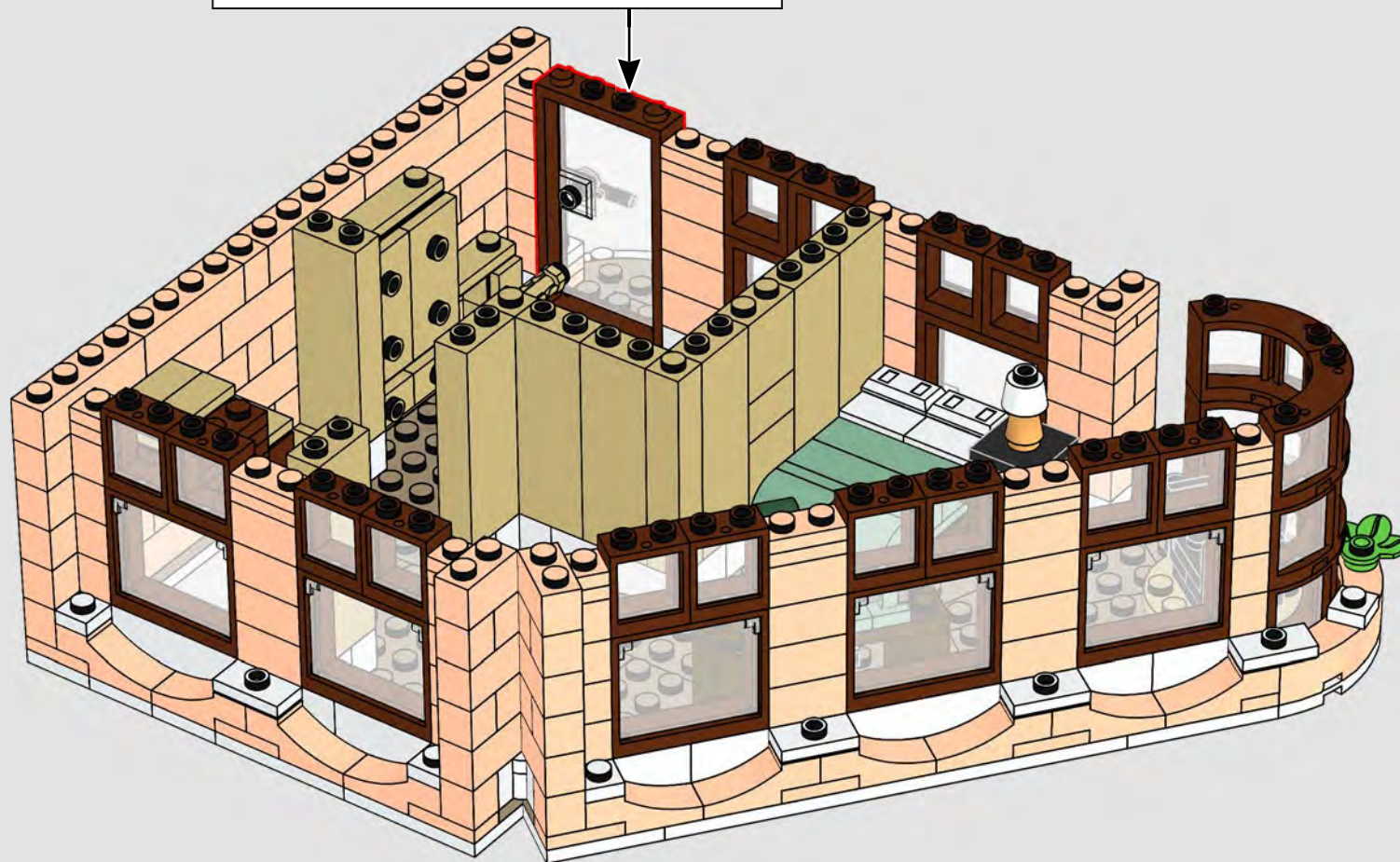

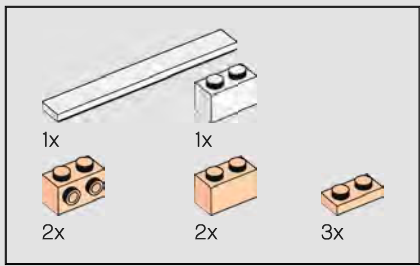

219

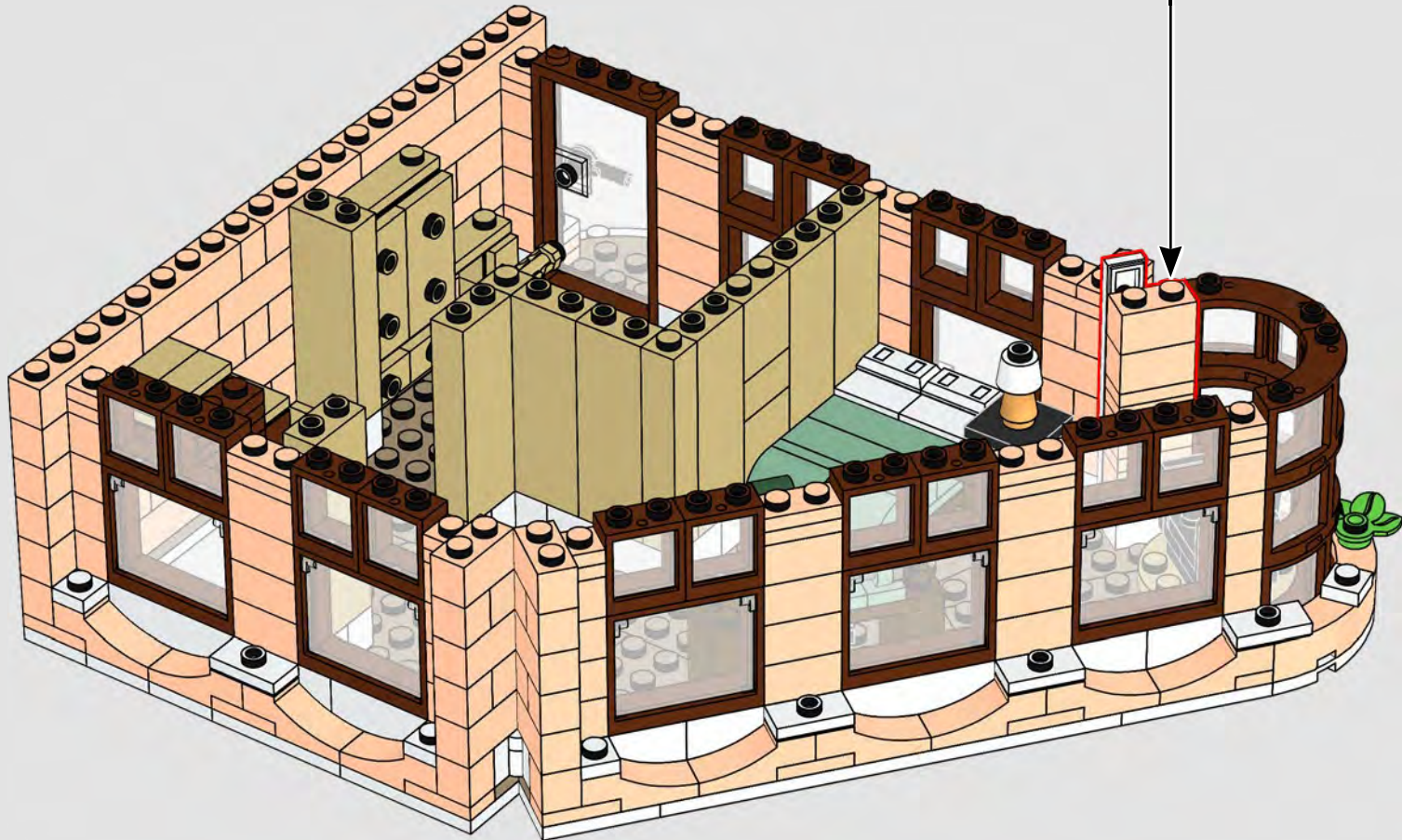
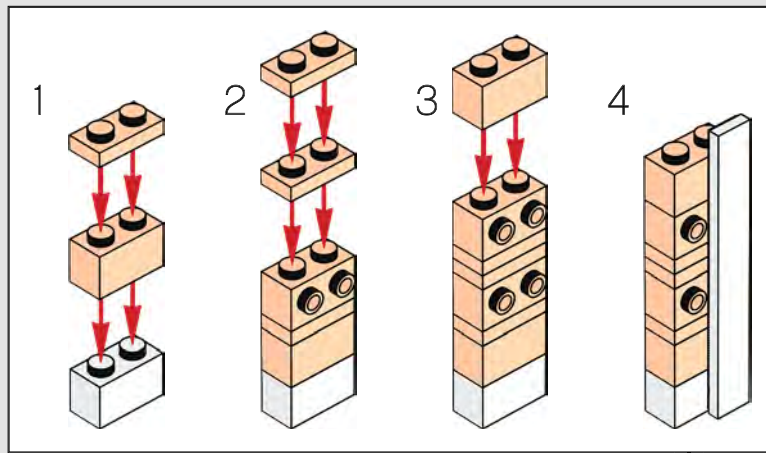

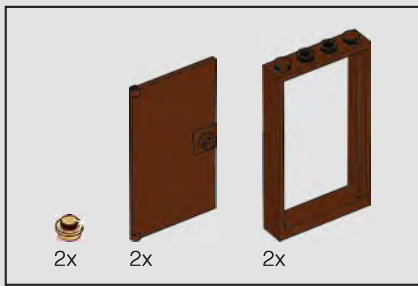

220

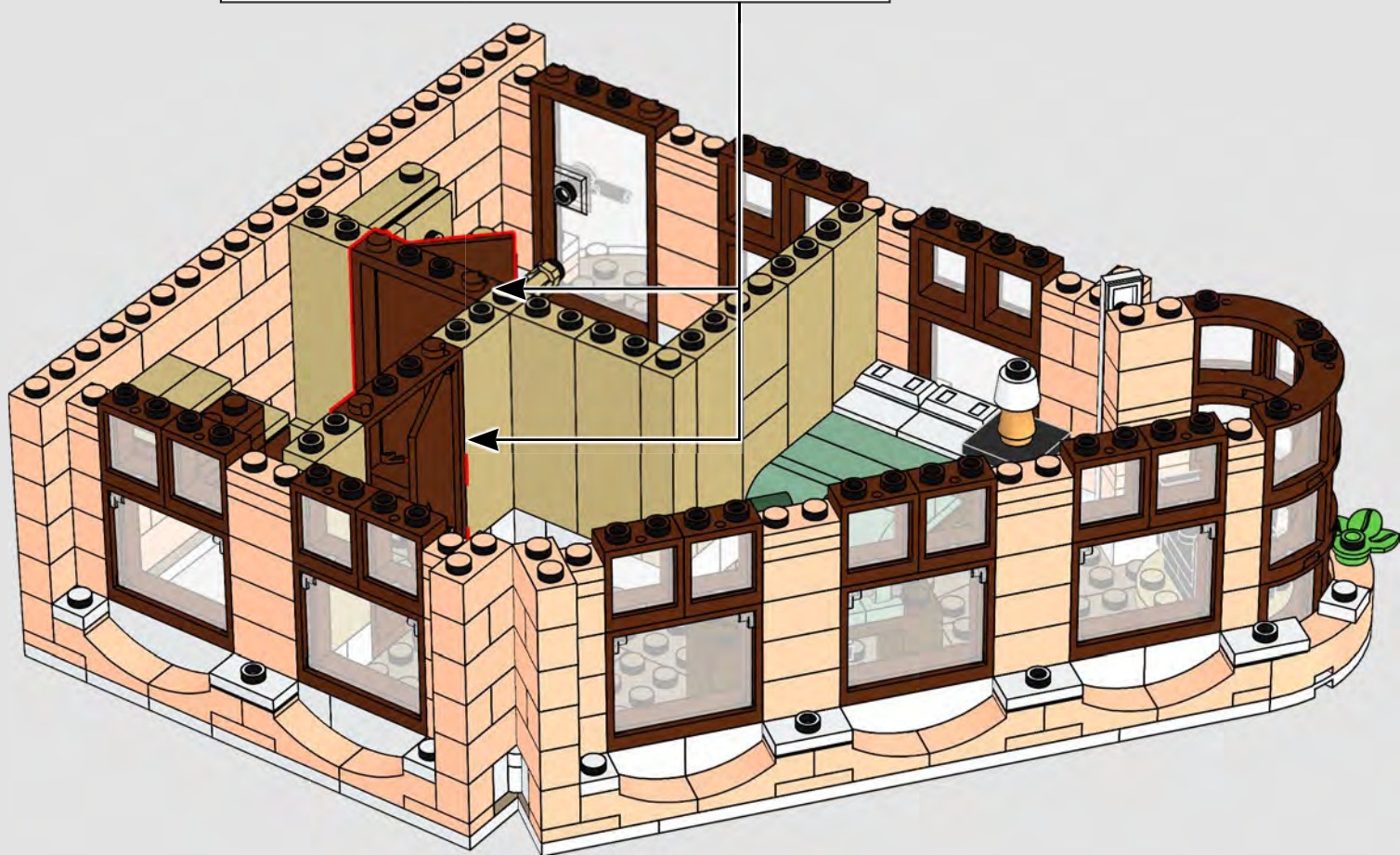
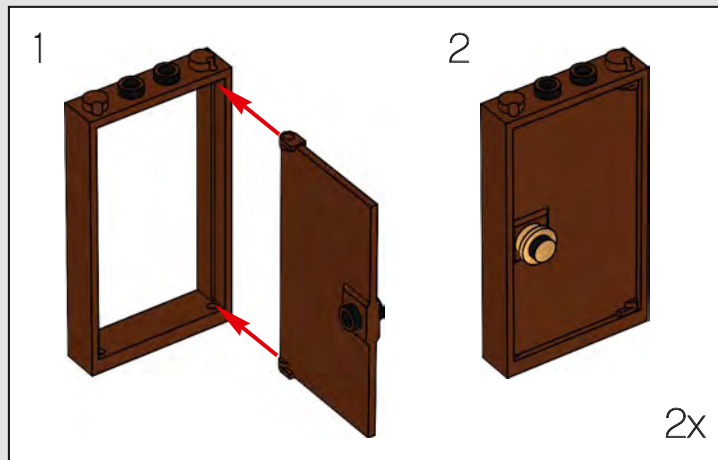

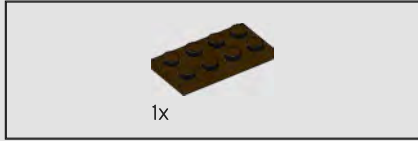

221



222

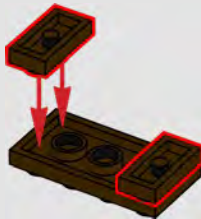

223

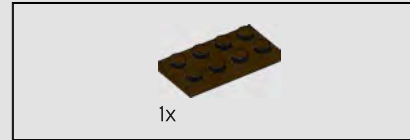
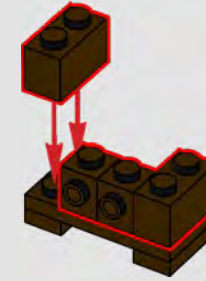
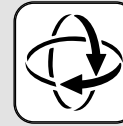

224

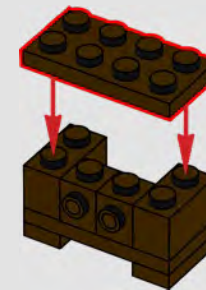



225

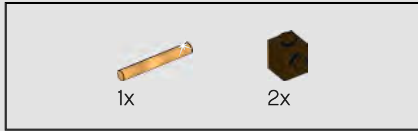
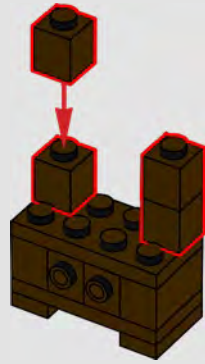

226

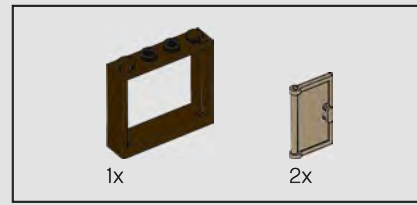
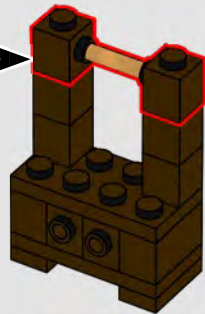
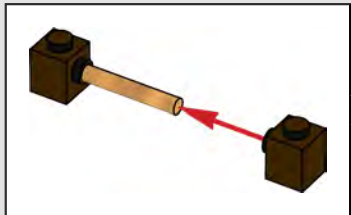

227

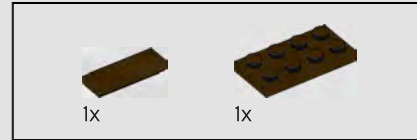
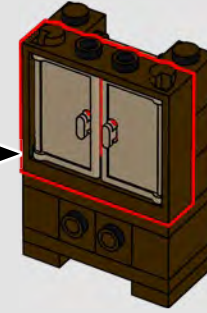
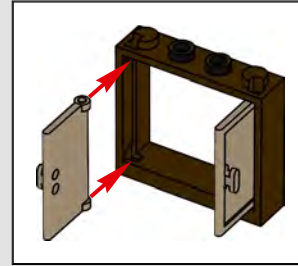

228

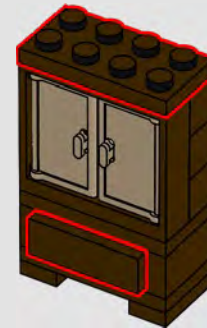

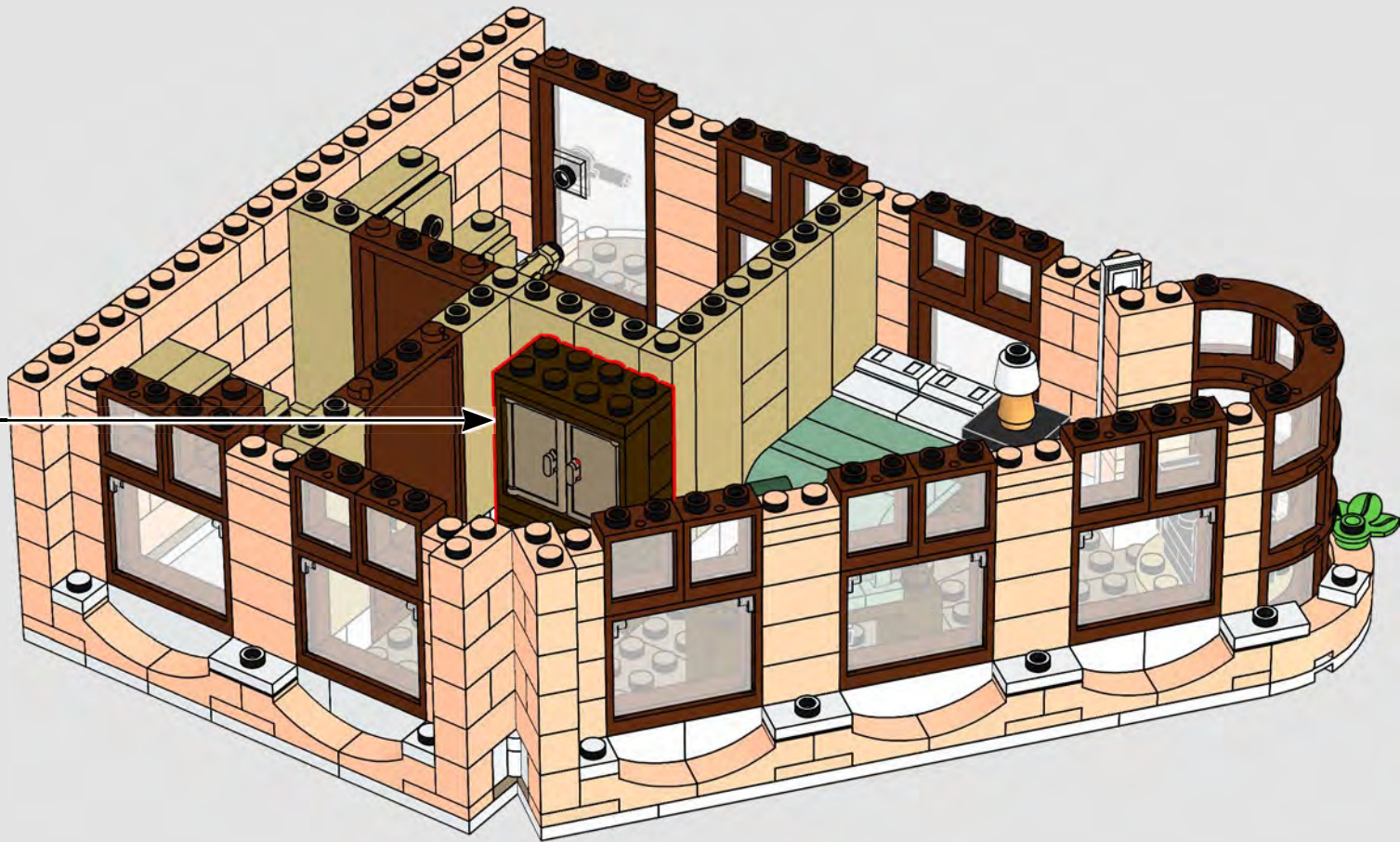



230

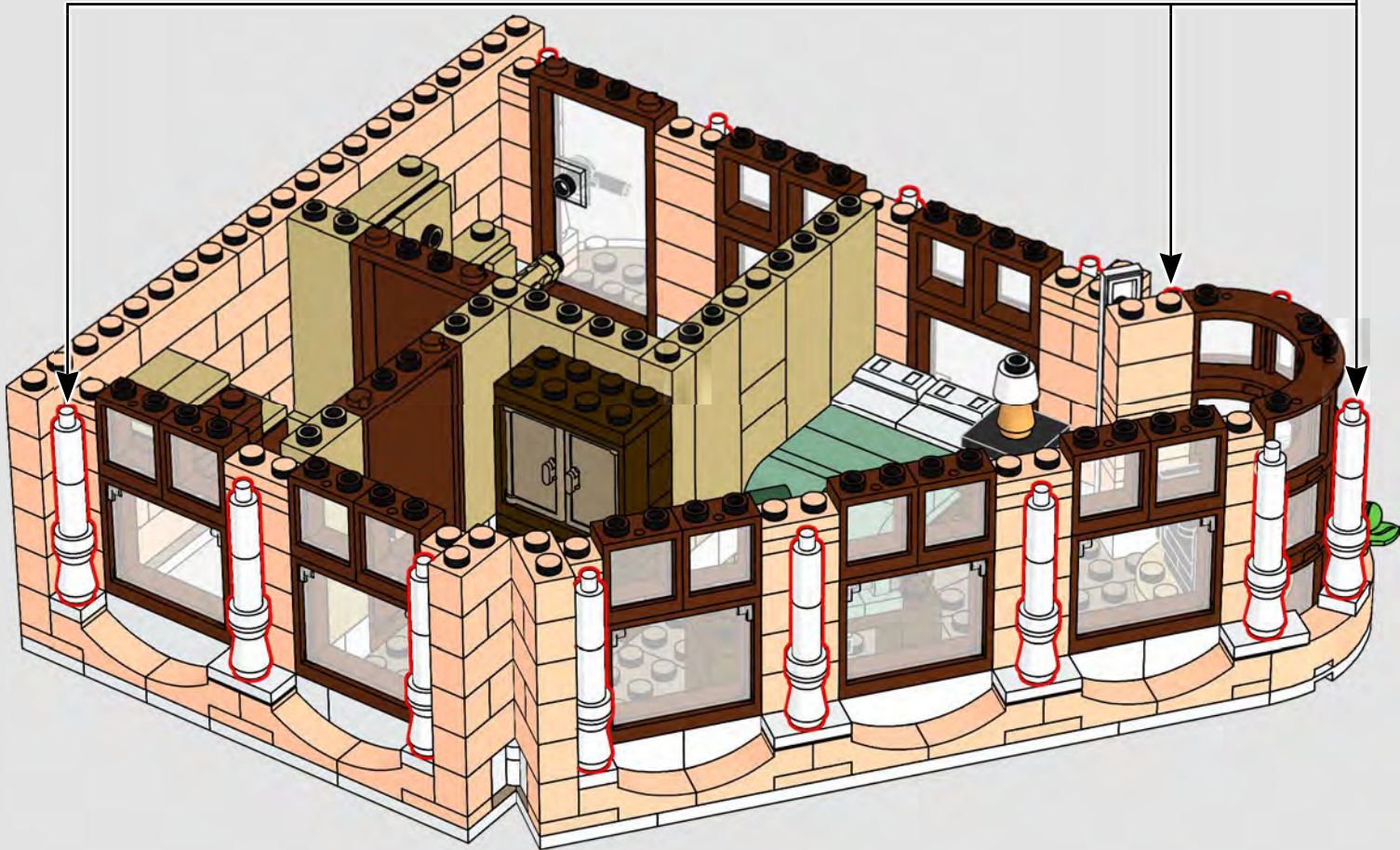
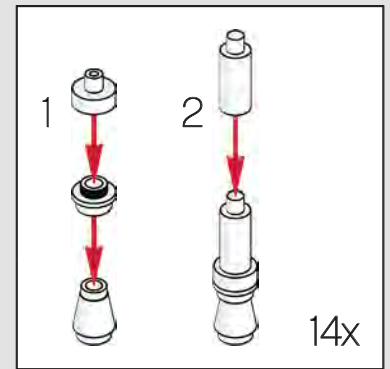



231

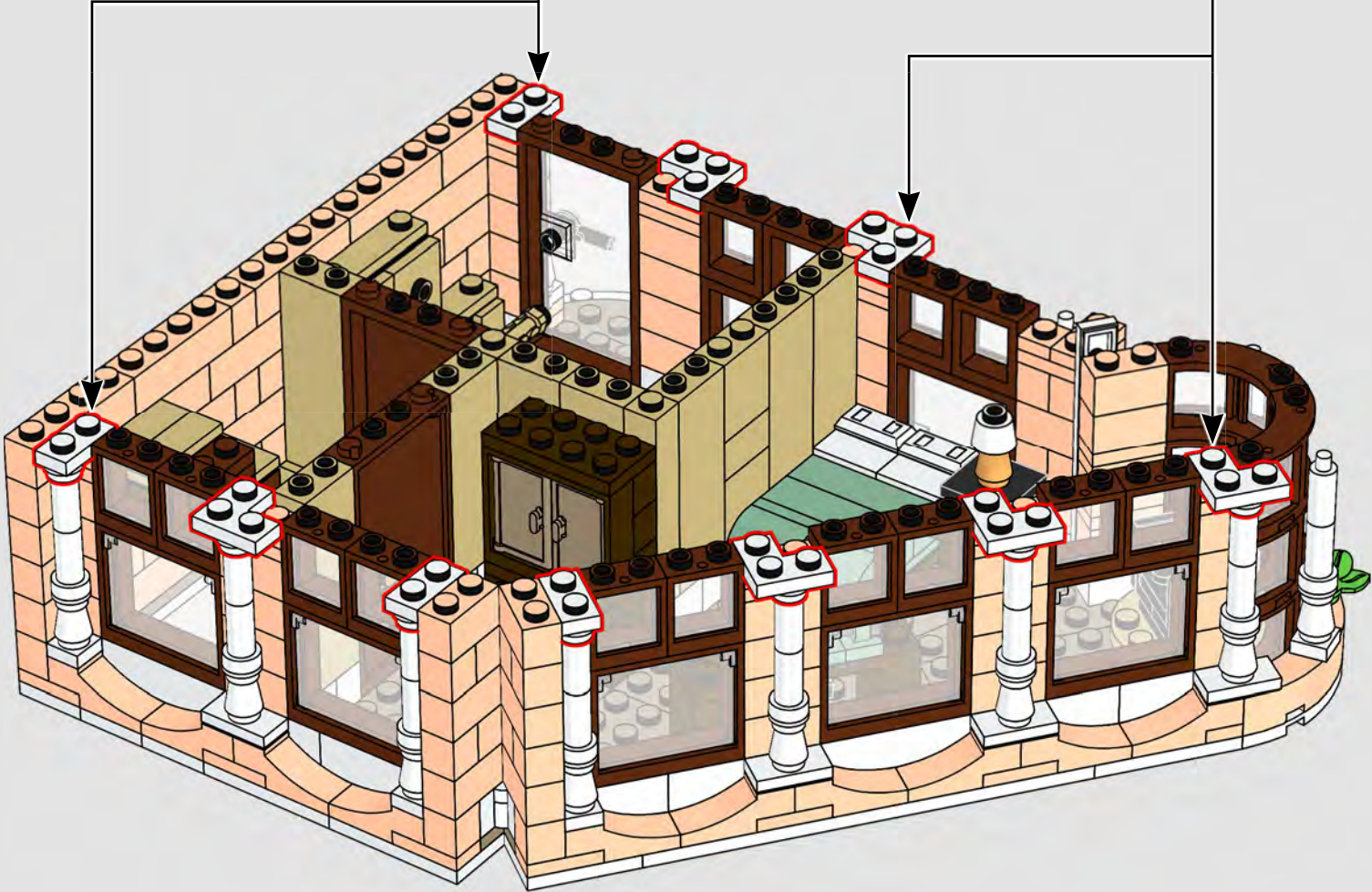
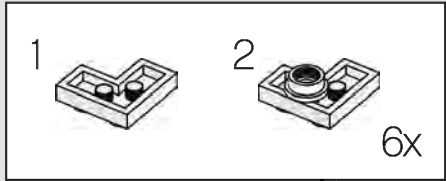
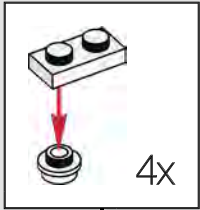



232

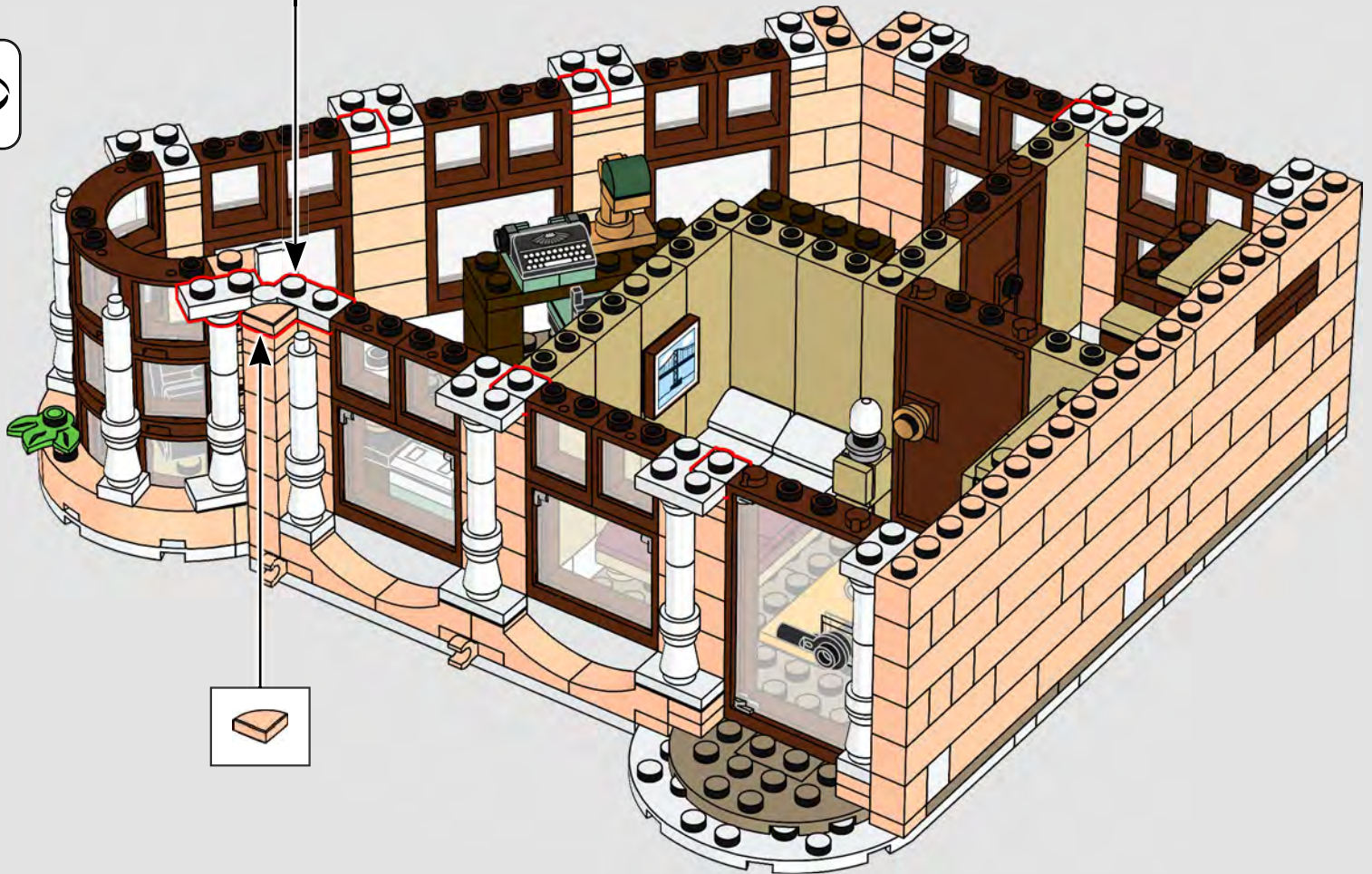
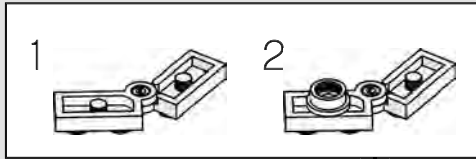

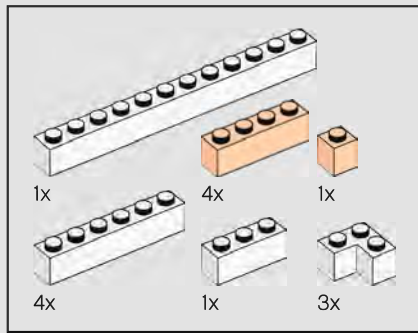

234



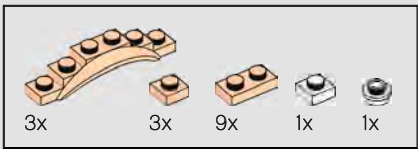

235

1



2

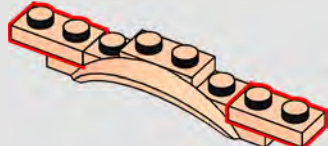

3

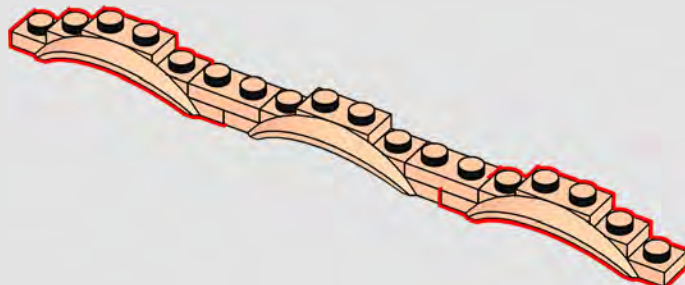

4

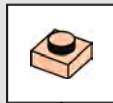
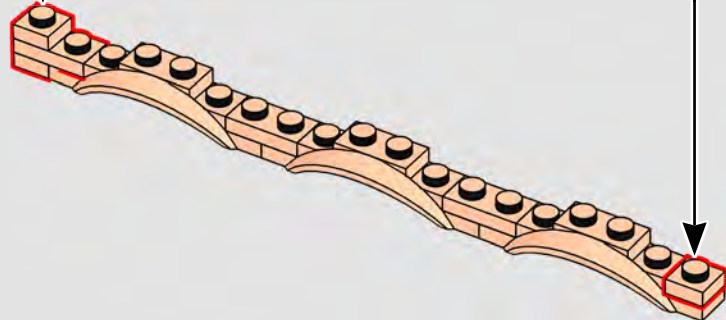
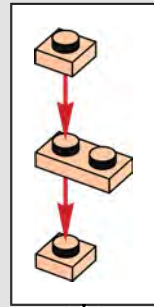

5

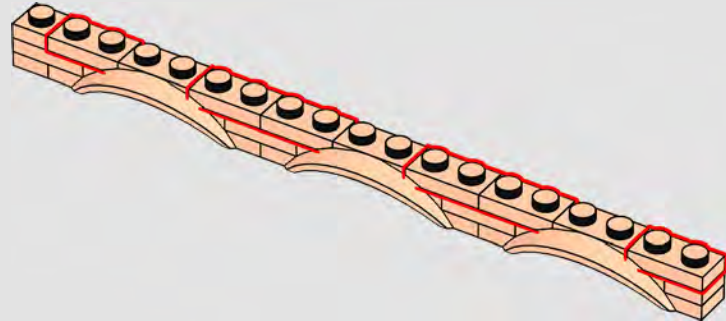

6

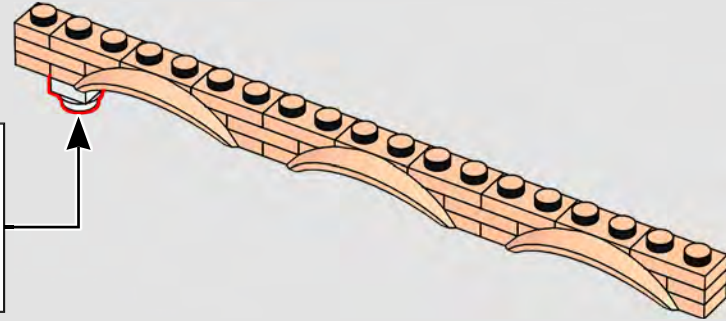
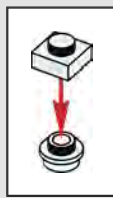





236

1

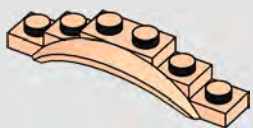

2

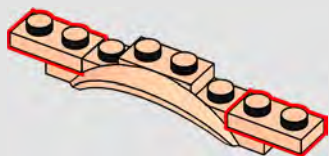

3

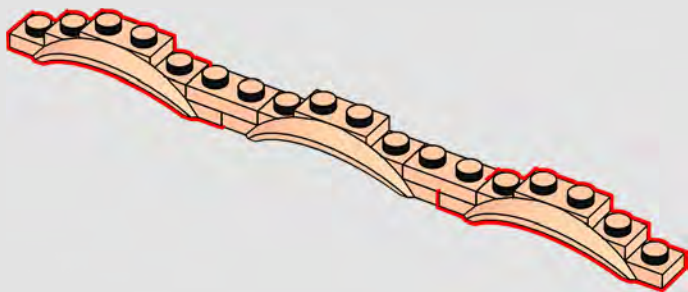

4

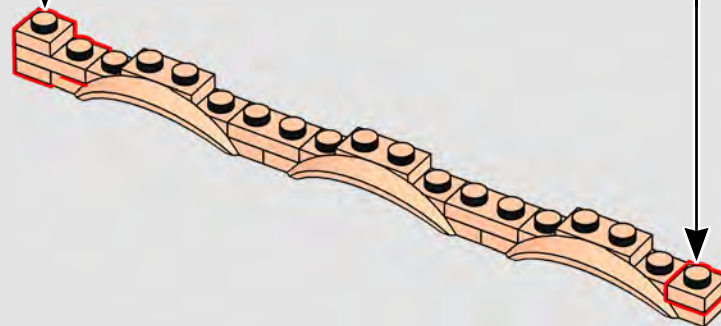
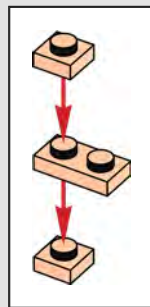

5

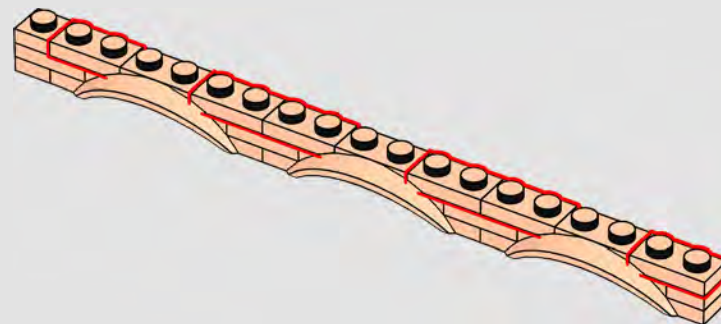



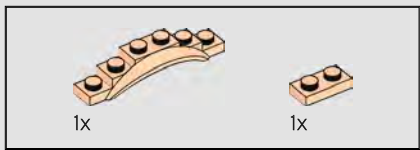

237

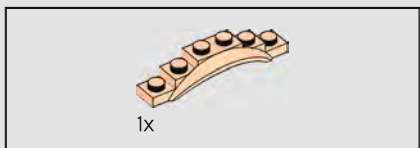
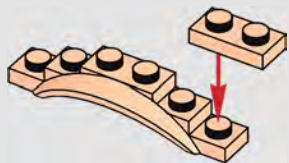

238

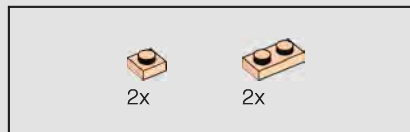
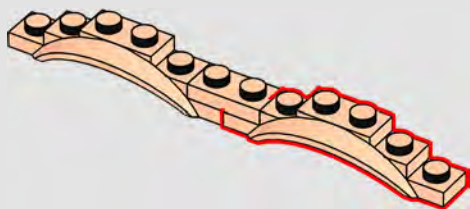

239

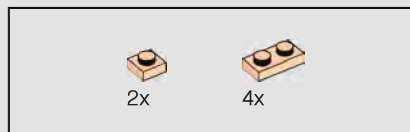
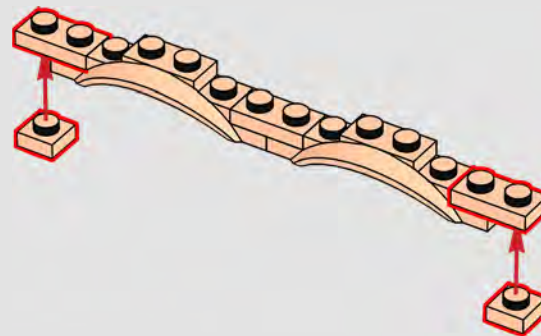

240

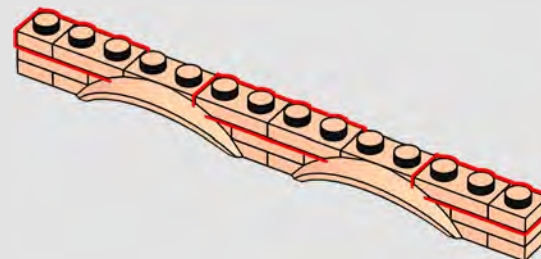



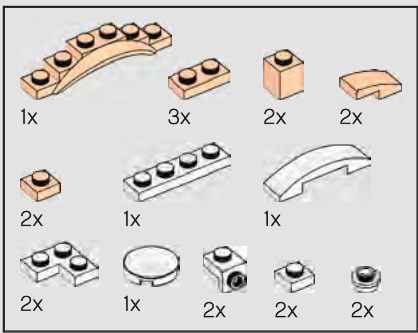

242

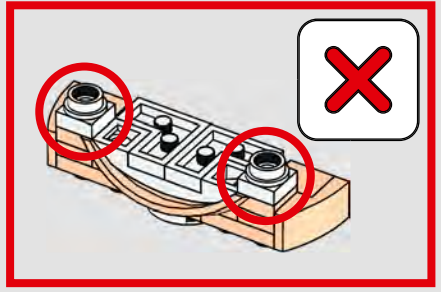
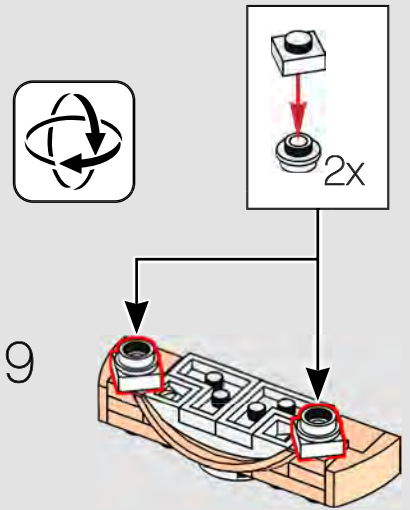
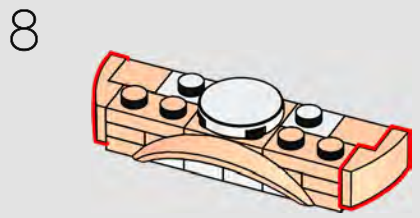
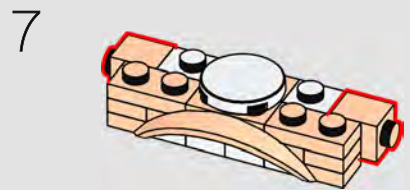
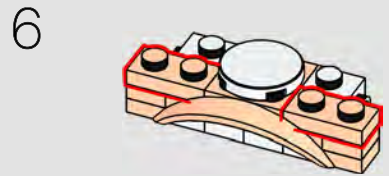
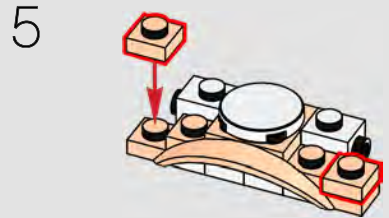
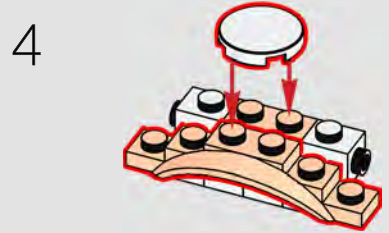
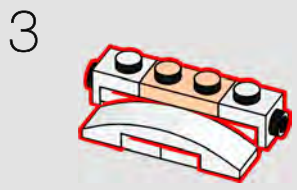
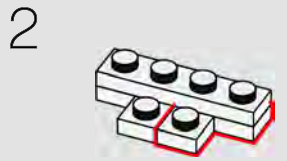
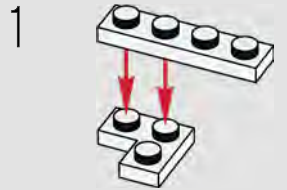



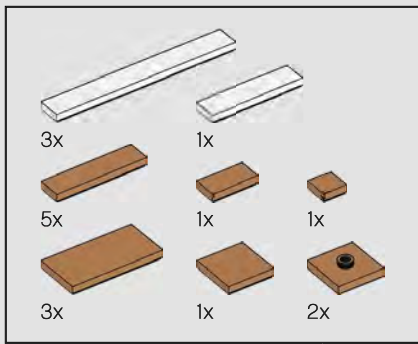

243



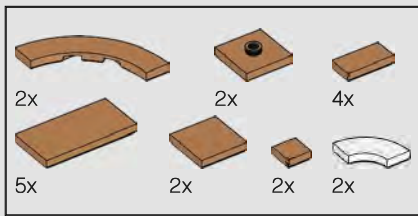

244



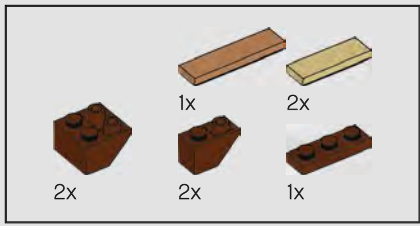

245

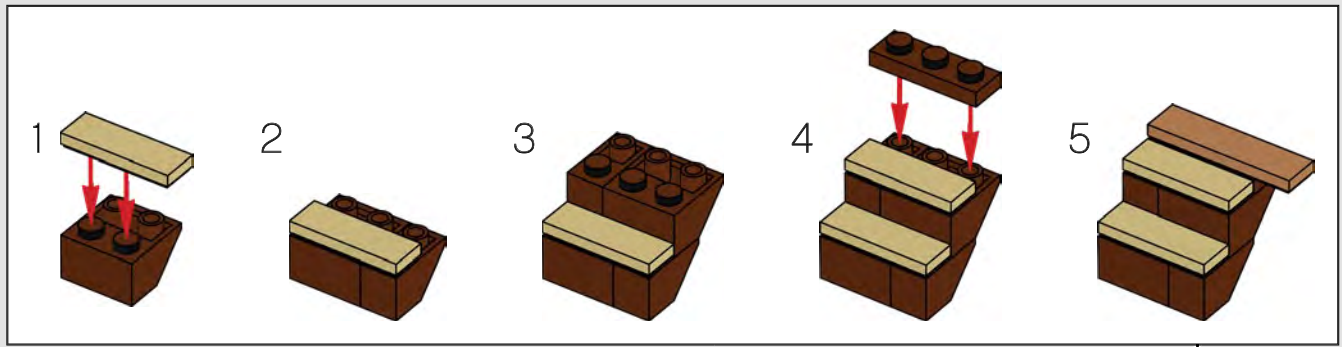

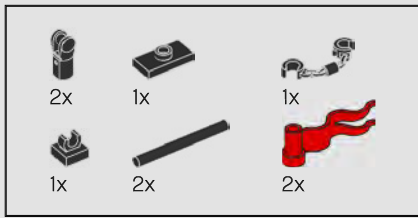

246

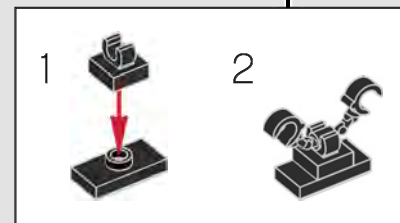
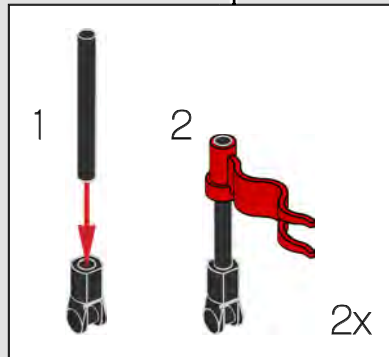



★ ★ ★ ★ ★
Minifigure skeleton legs were first used
as a balcony detail in the 10185 Greengrocer set.

247

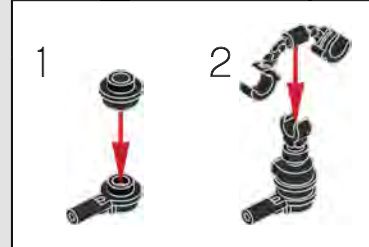
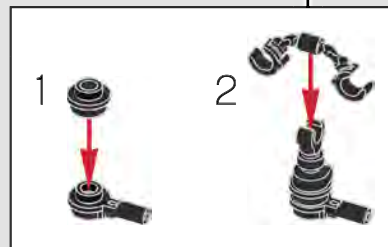
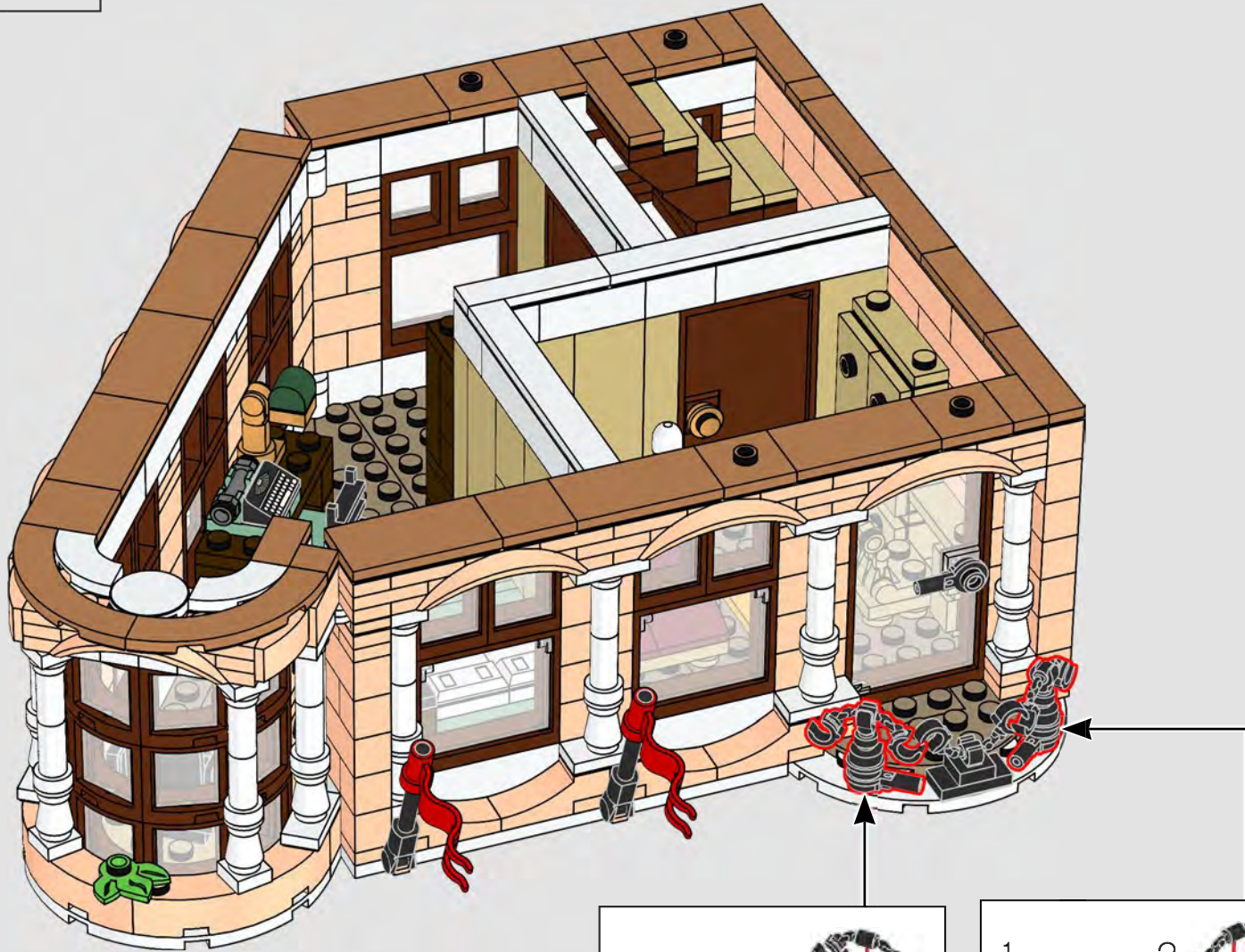

248



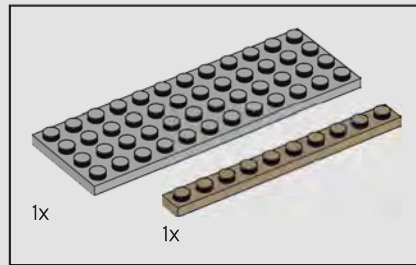
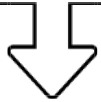

249

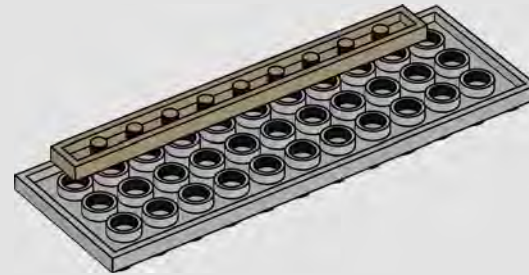

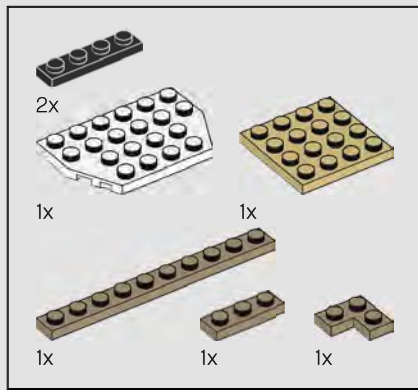

250

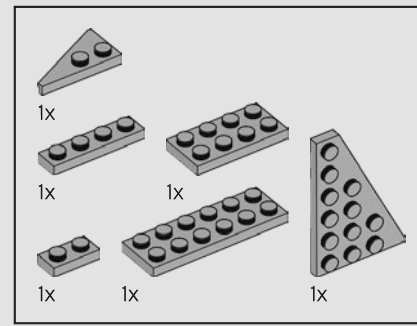
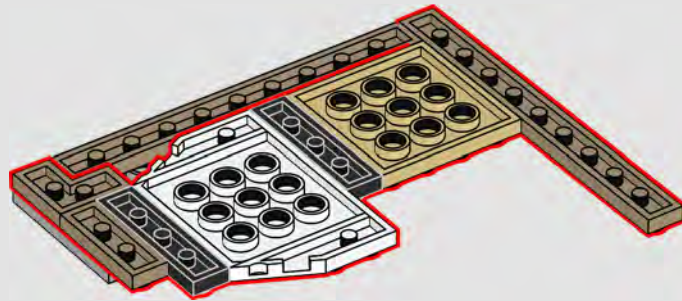

251

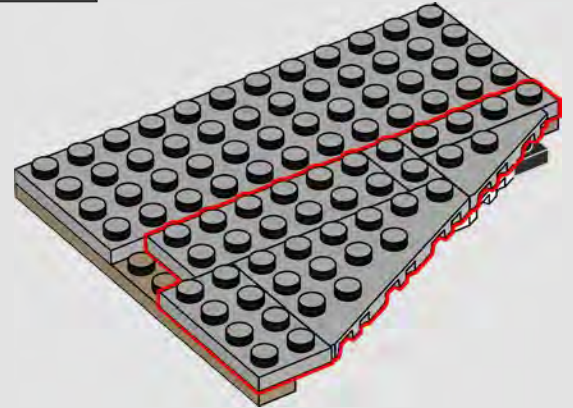
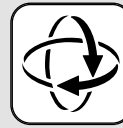

252

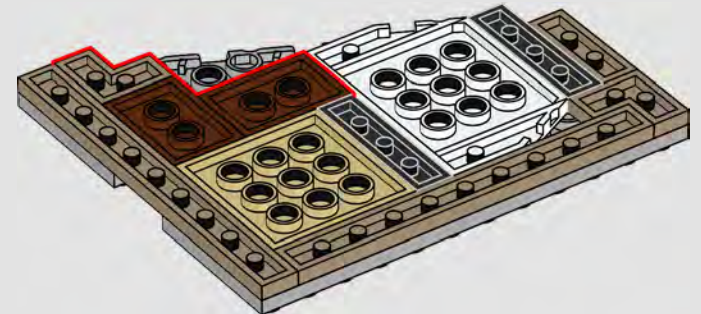

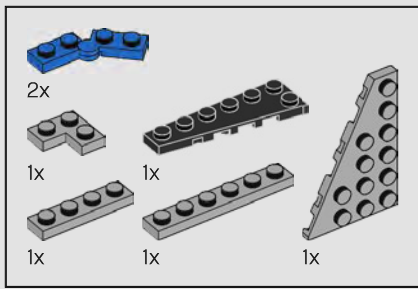

253

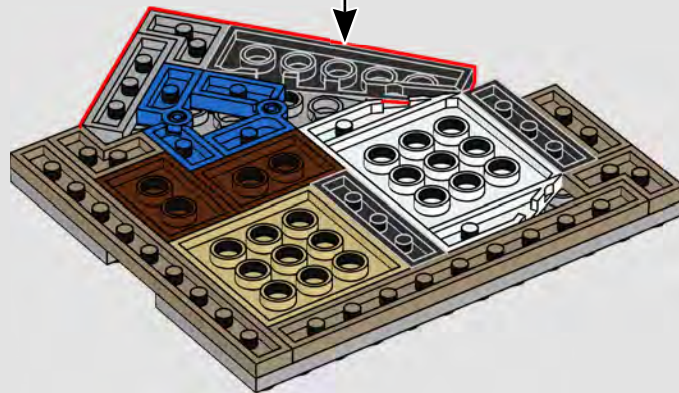
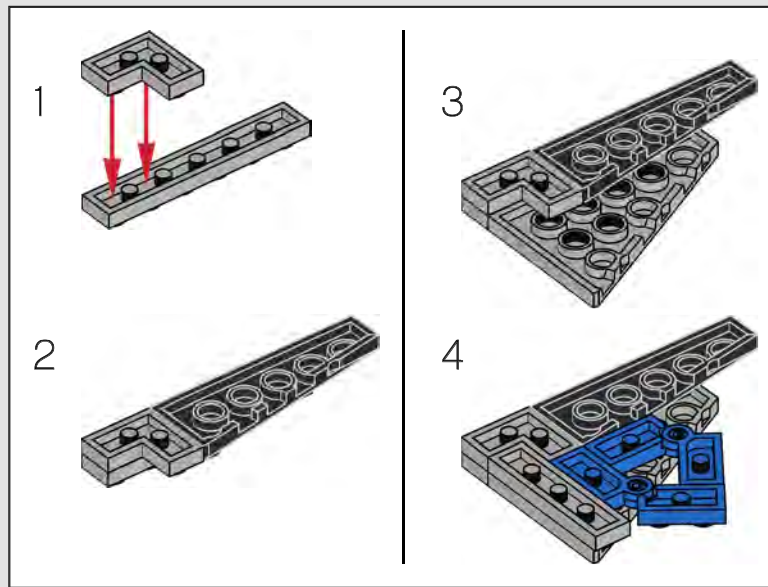

The terrace is built using reflected triangle geometry. Combined with the Hotel building itself, this creates Pythagorean triangles that align perfectly with the LEGO® grid system.

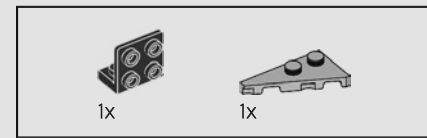

254

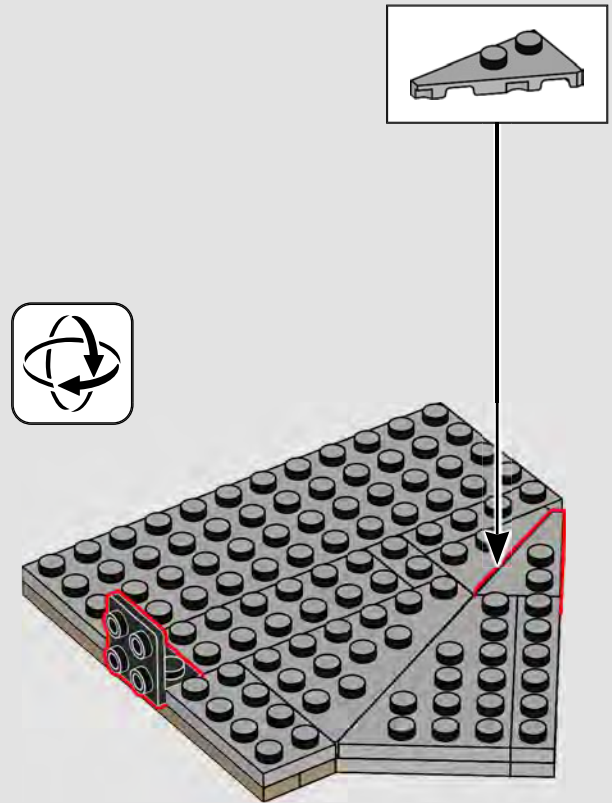
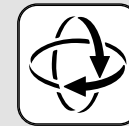

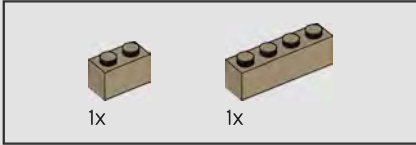

255

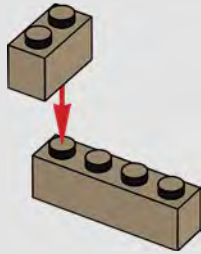

256

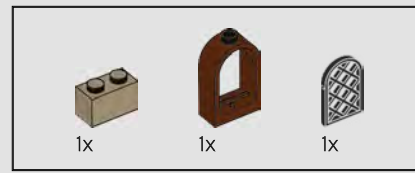
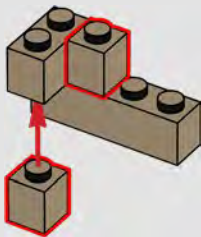

257

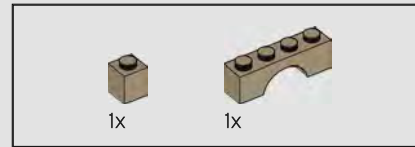
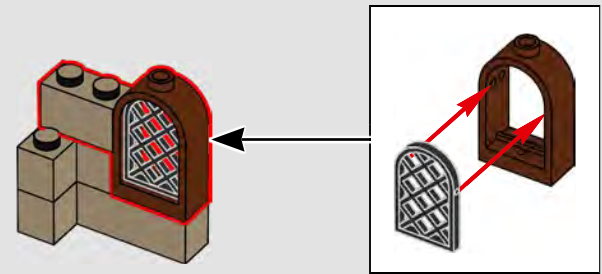

258

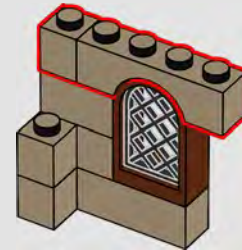



259

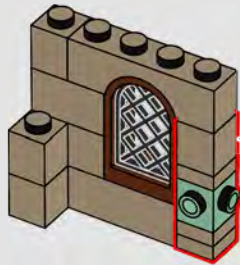
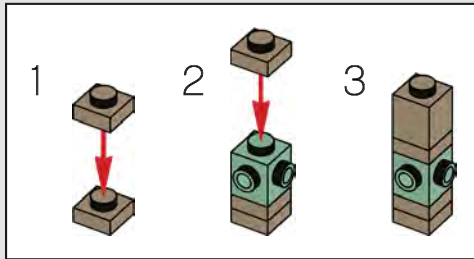

260

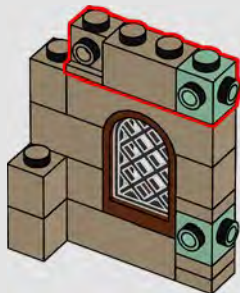

261

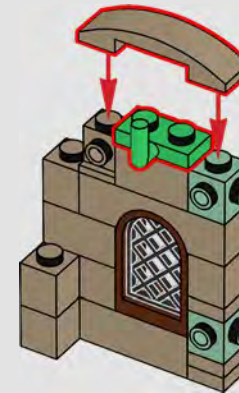

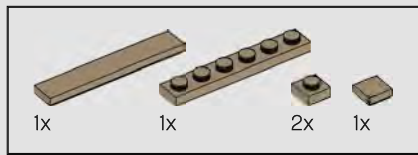

262

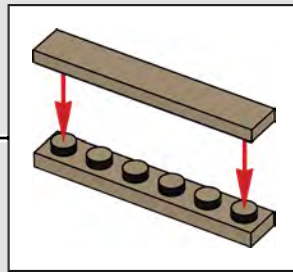
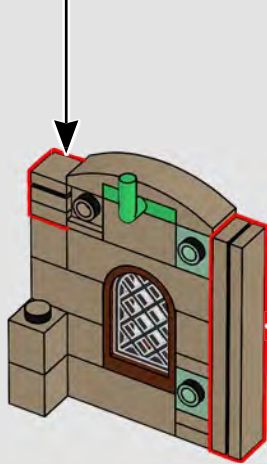
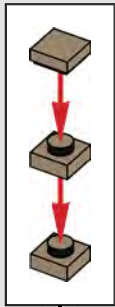

263

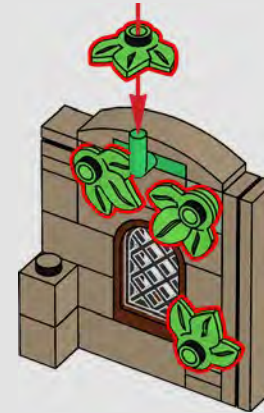

264

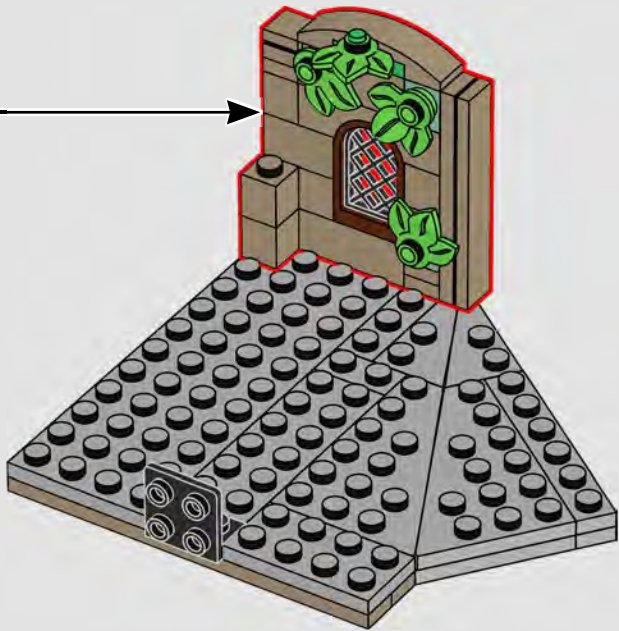

265



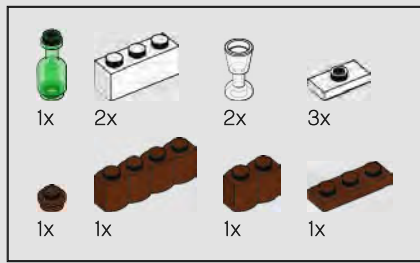

266

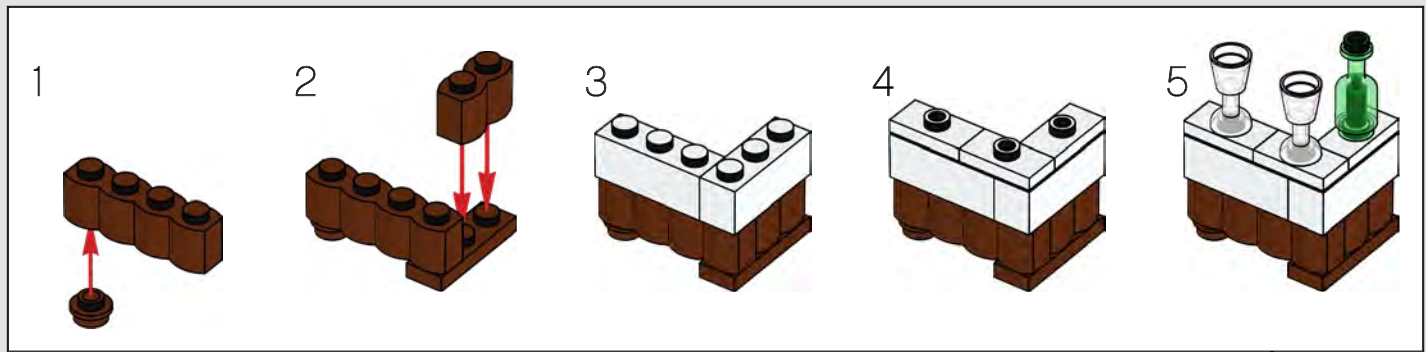

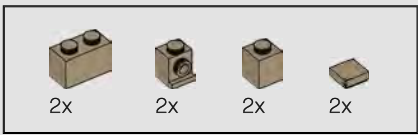

267

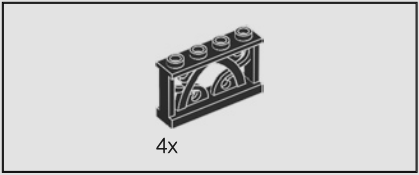
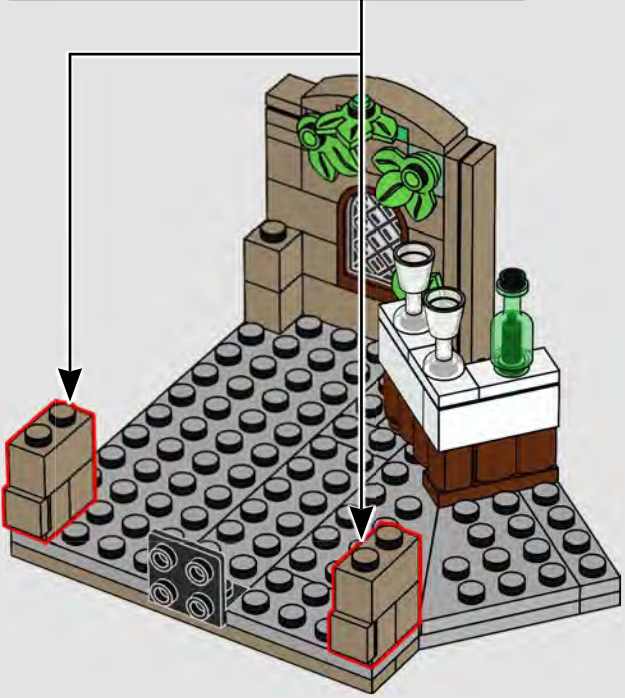
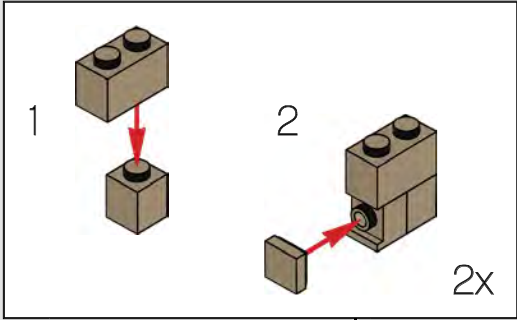

268



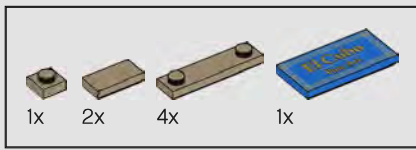

269

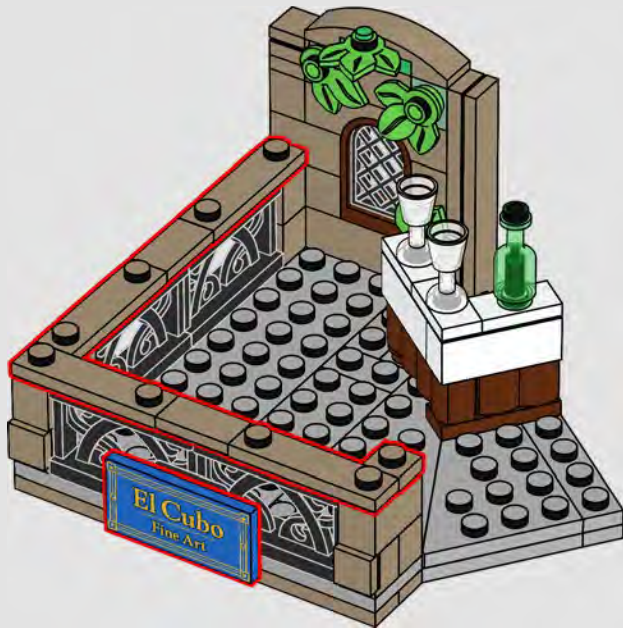

270

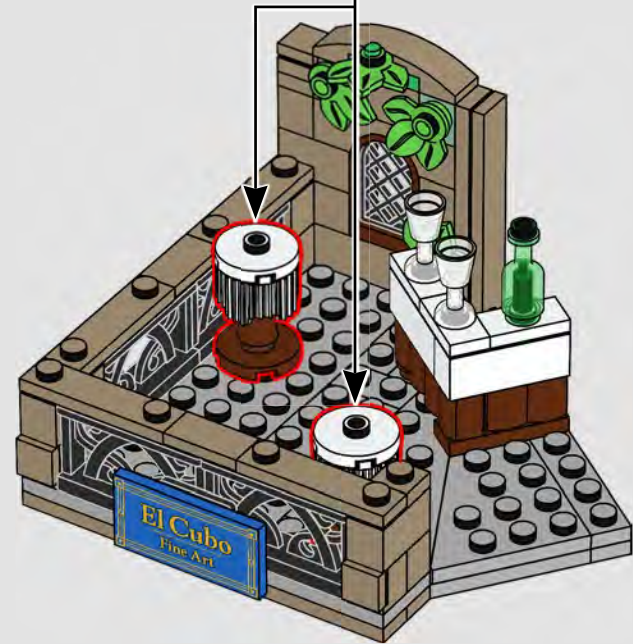
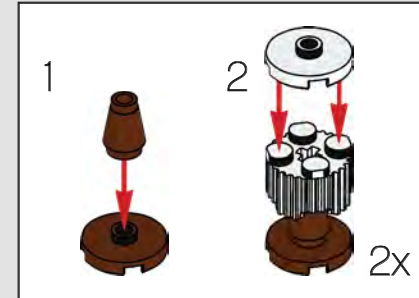

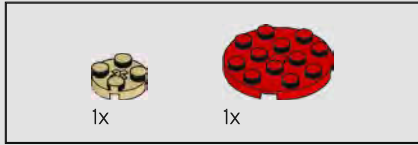

271

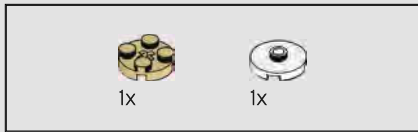

272



273

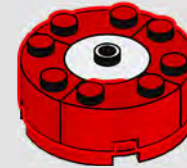

274

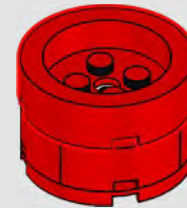



275

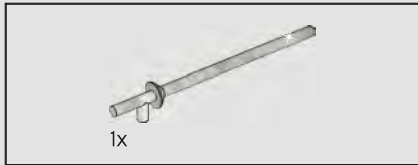
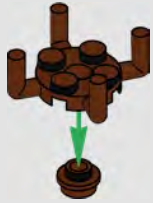

276

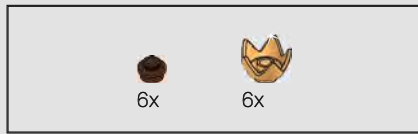

277

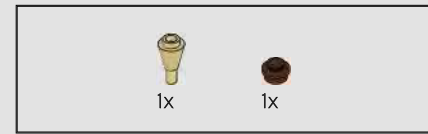
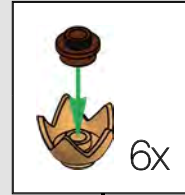

278

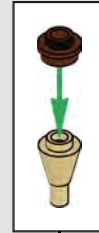

279



280

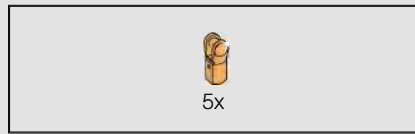

281

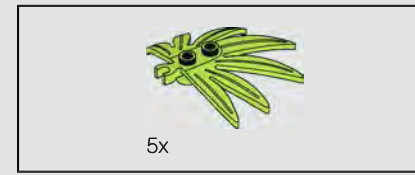

The elements used to make the trunk of the palm tree first appeared as the crown of Queen Watevra Wa'nabe from *The LEGO® Movie 2™*.

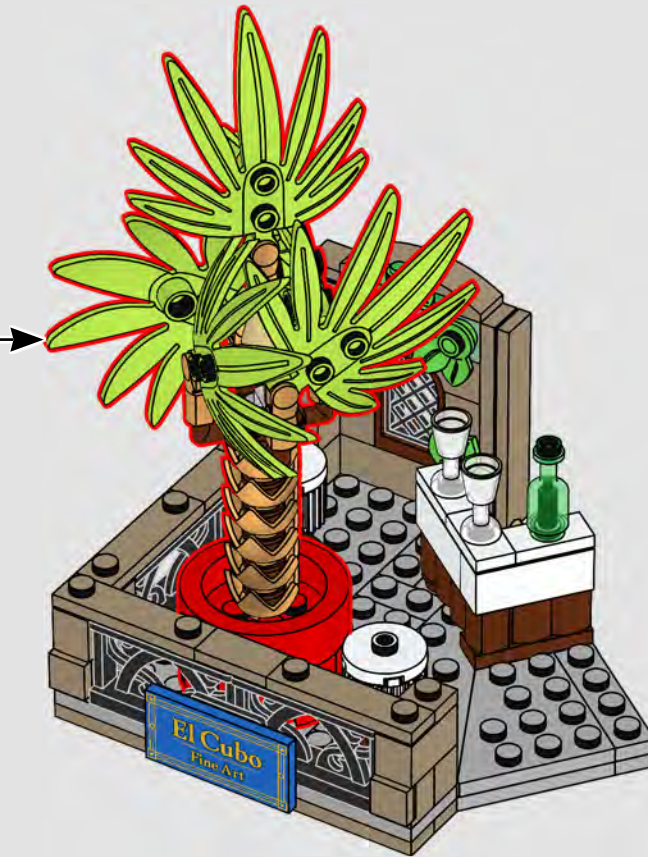



283

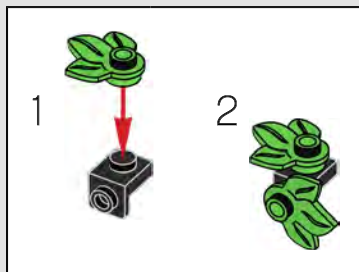
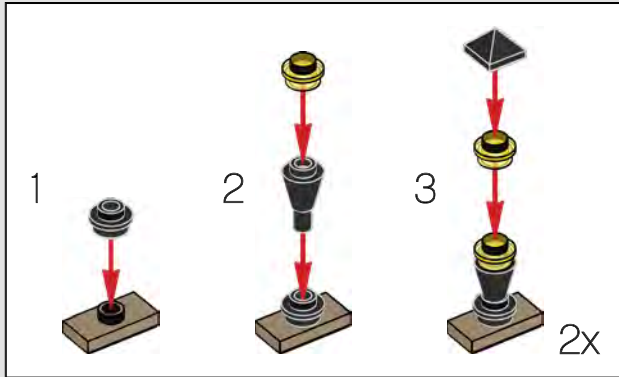

284



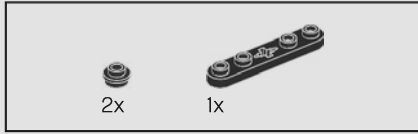
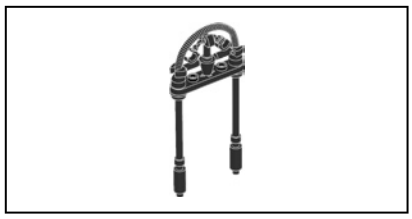

285



286



287

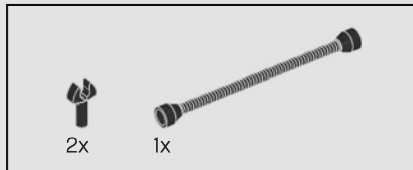

288

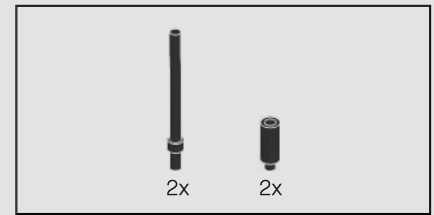
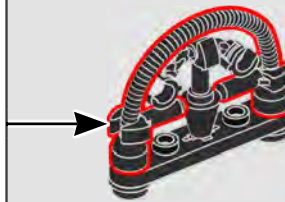
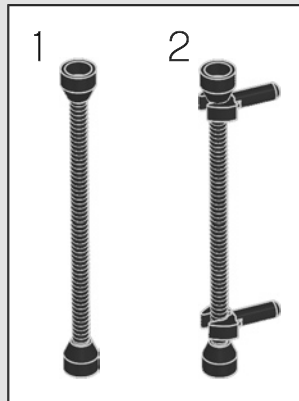

289

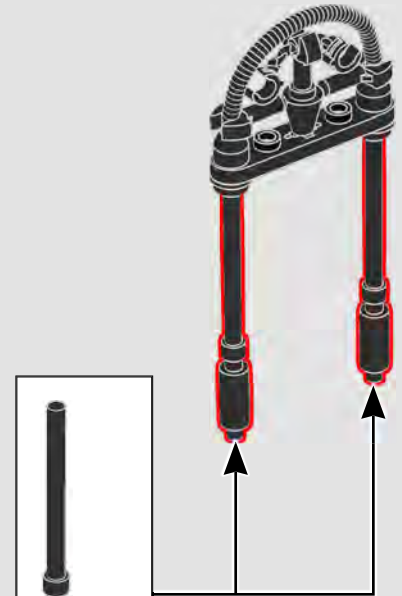



A wrought-iron gate first appeared in the 10190 Market Street set. It was notable for its use of minifigure whips to make organic curving details.

290



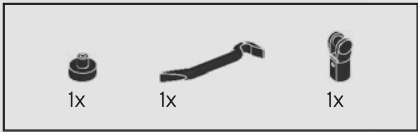

291

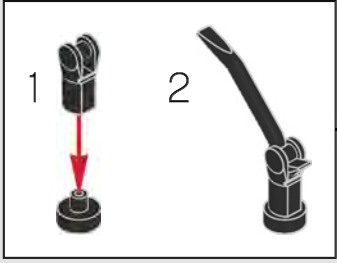

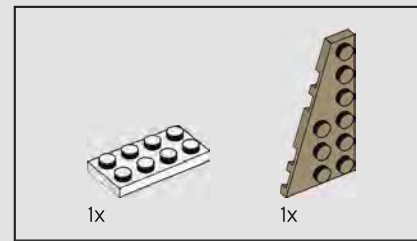
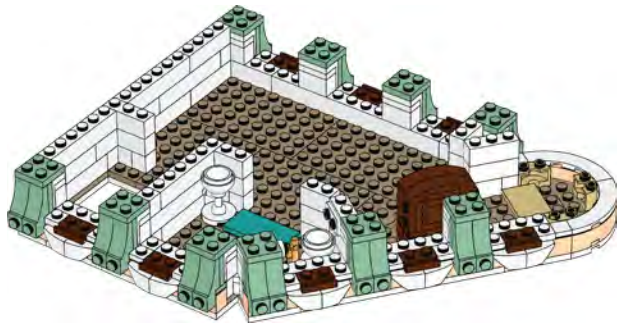
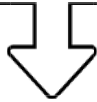

292

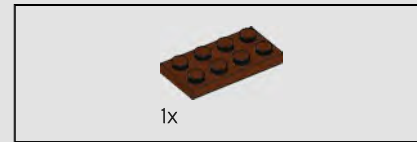
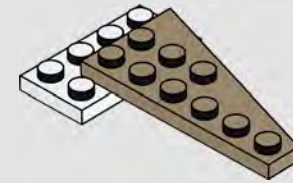

293

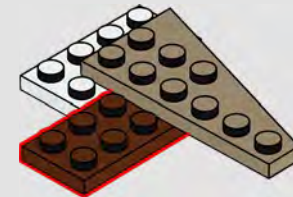

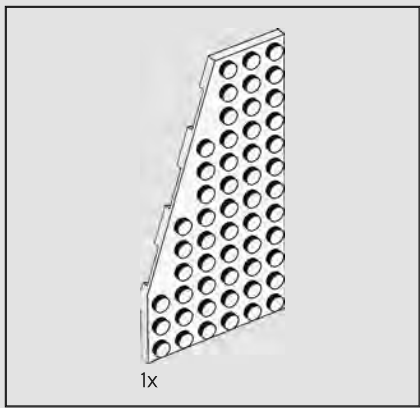

294

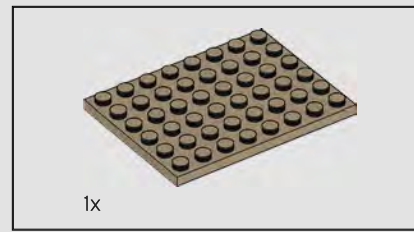
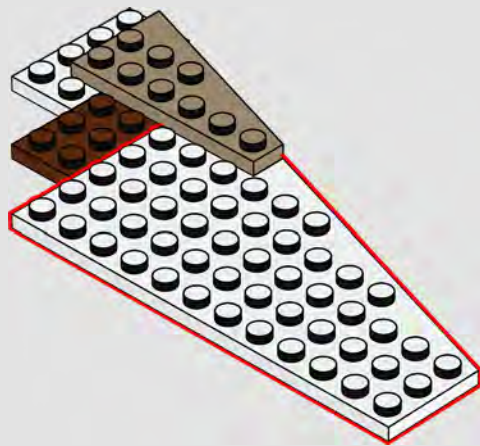

295

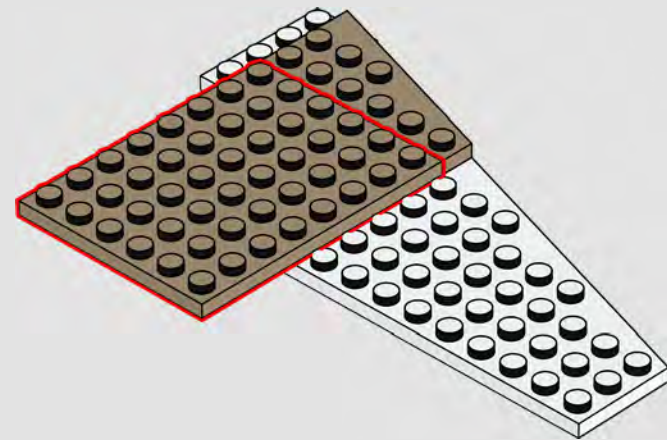

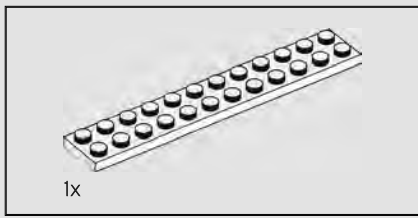

296

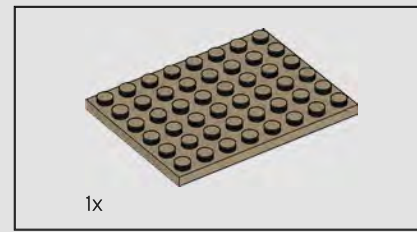
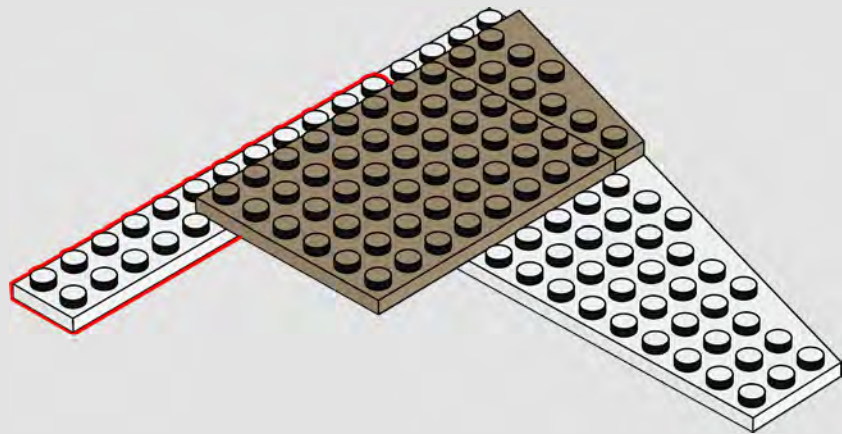

297

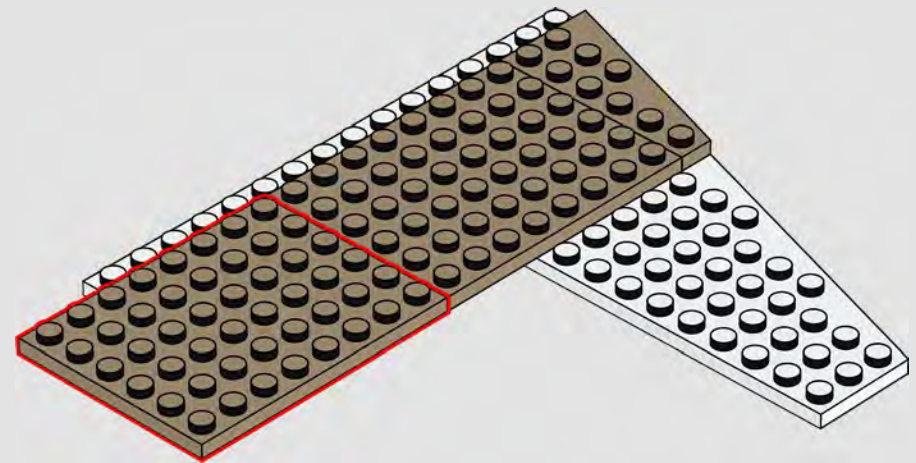

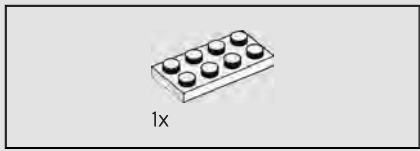

298

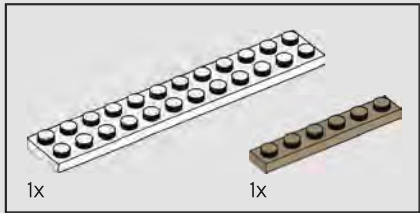
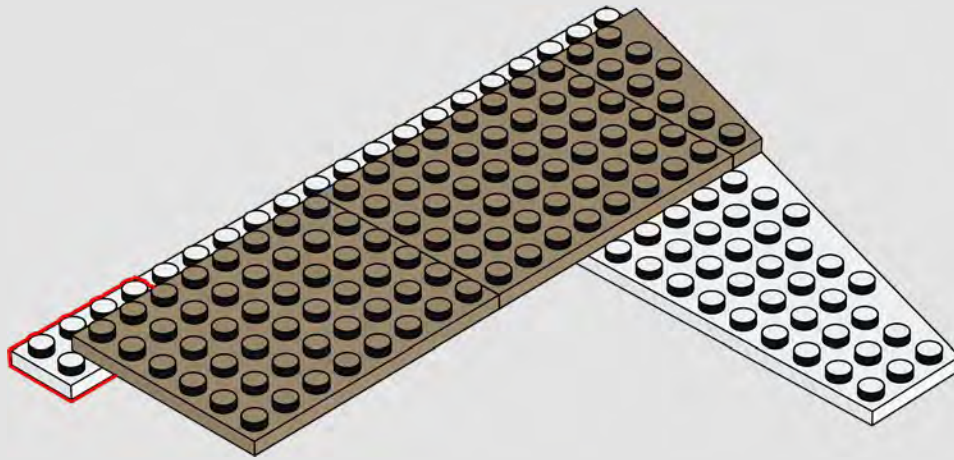

299

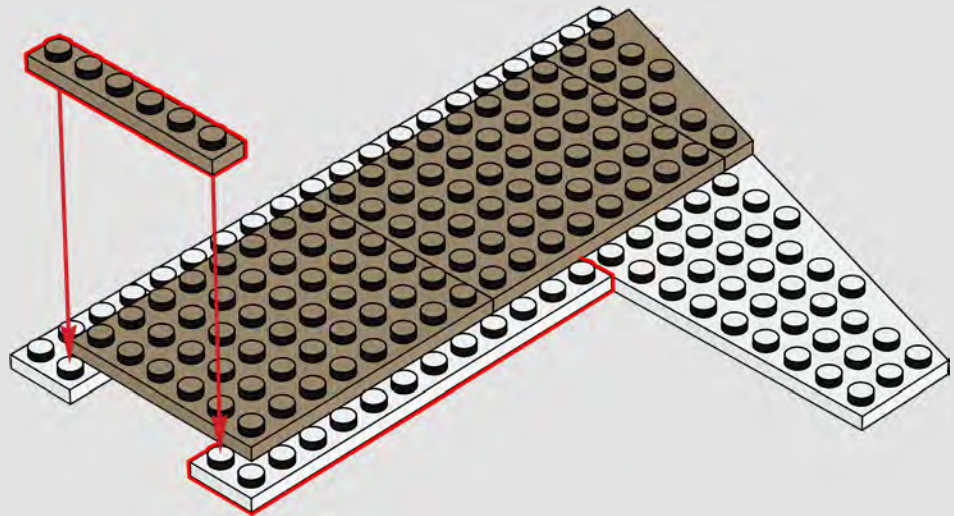

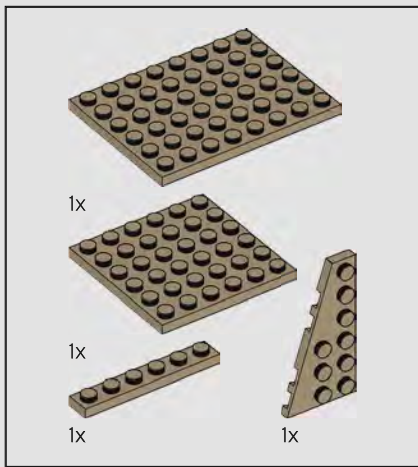

300

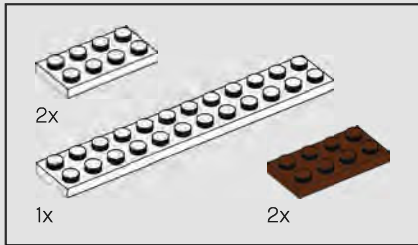
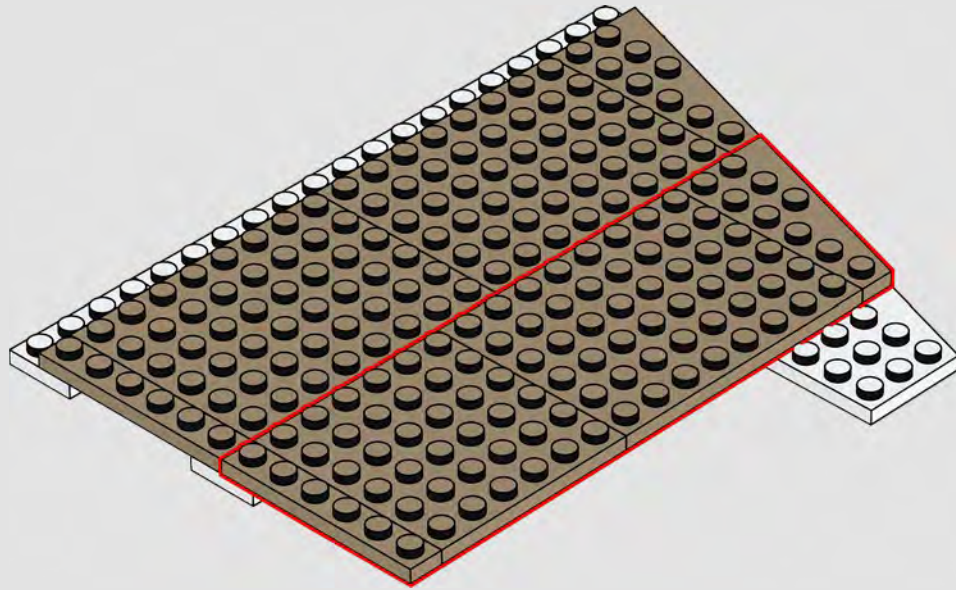

301

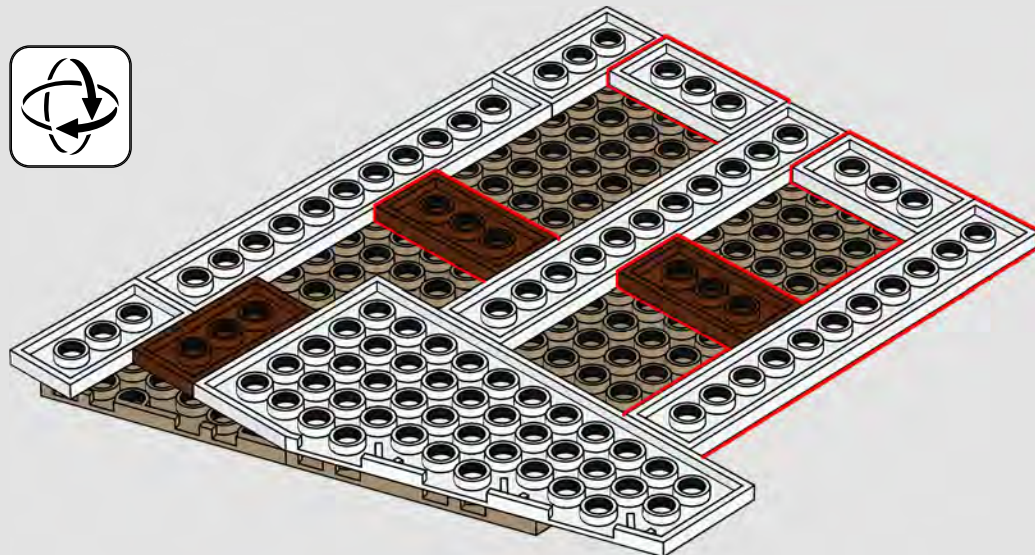

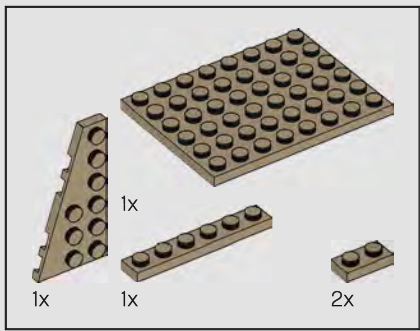

302

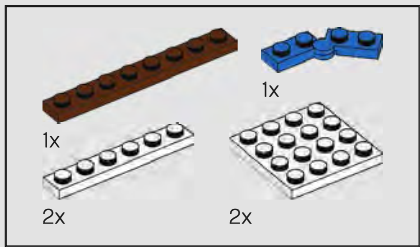
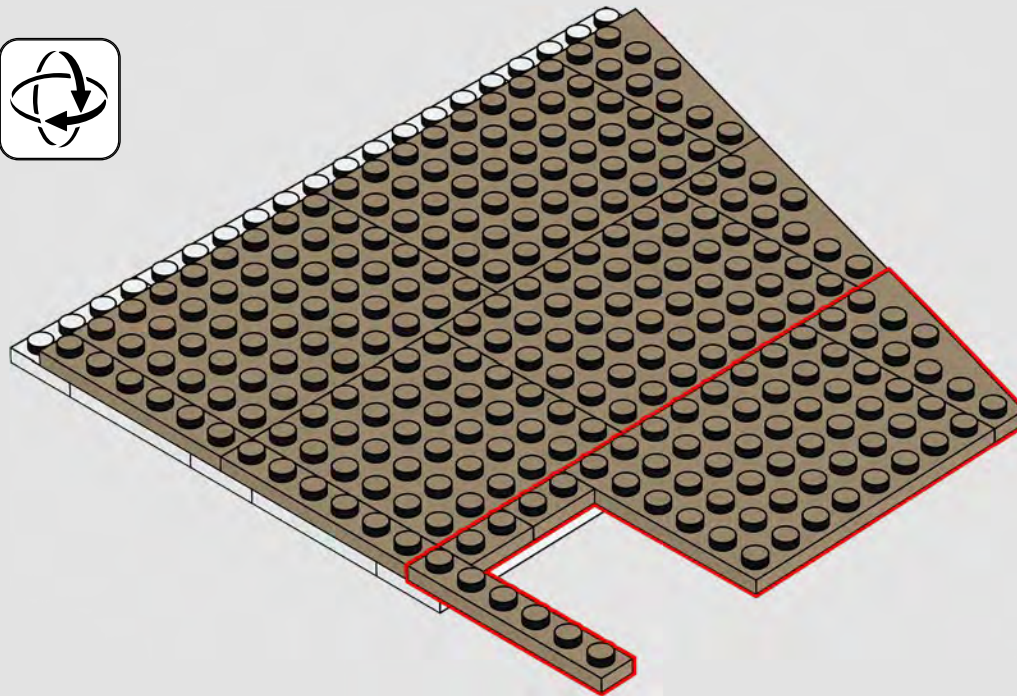

303

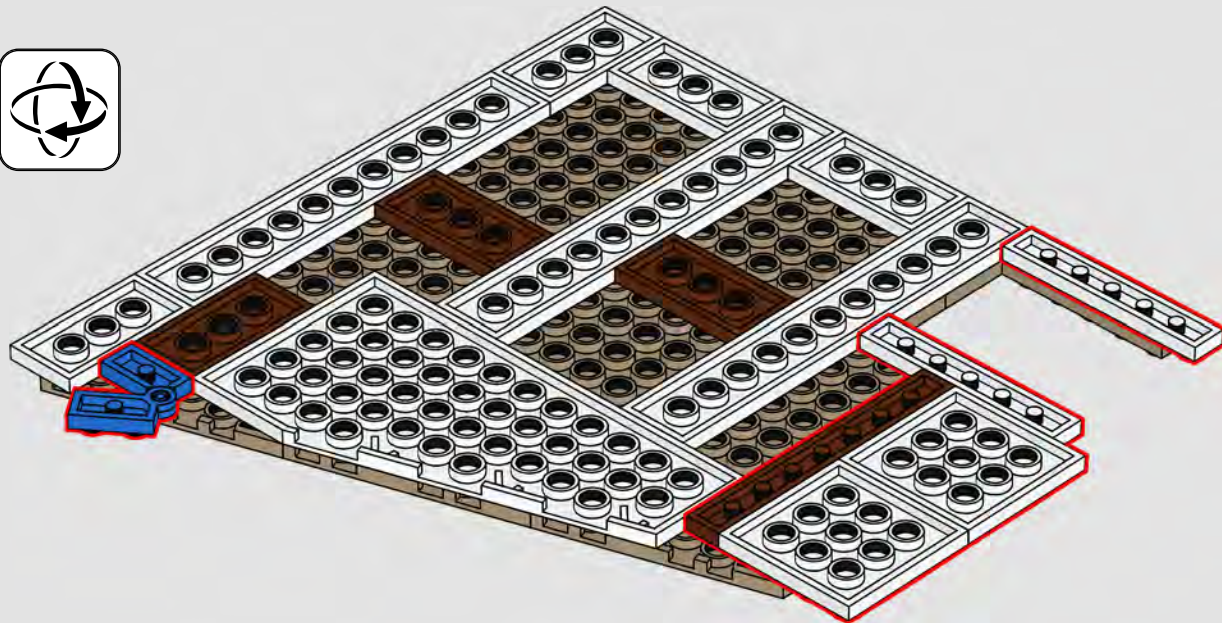

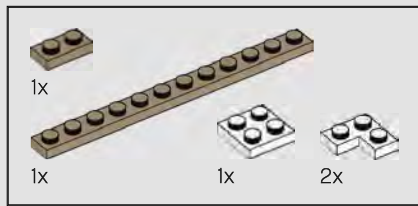

304

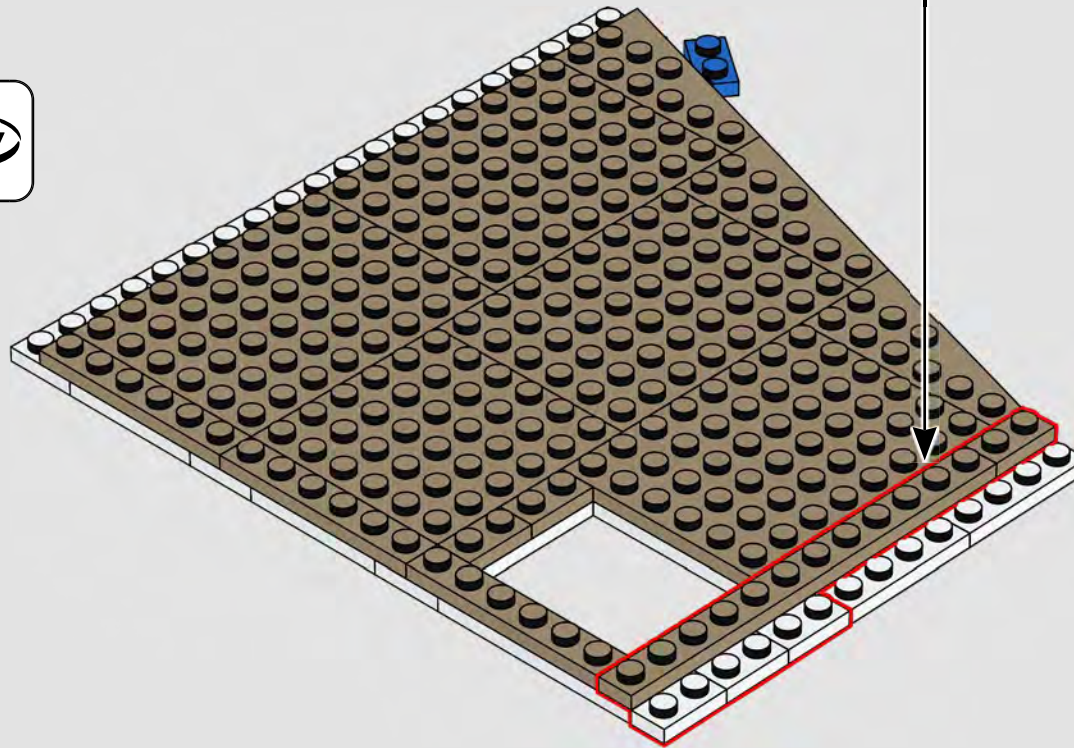
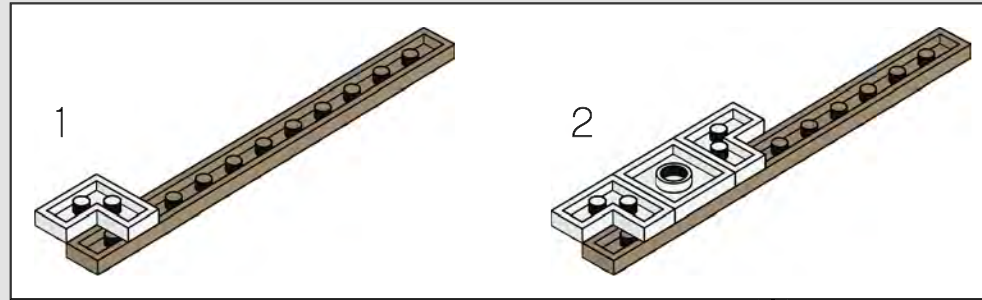

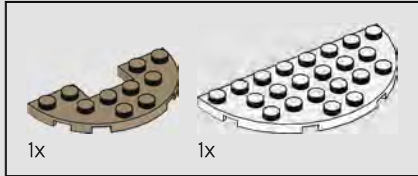
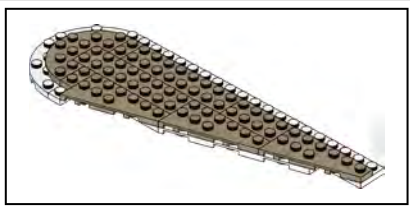

305

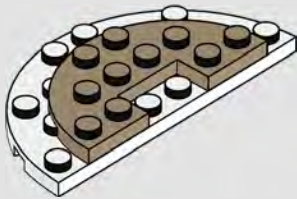

306

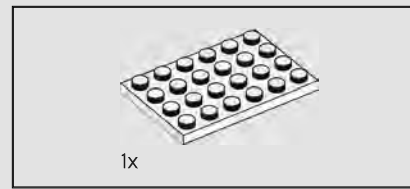
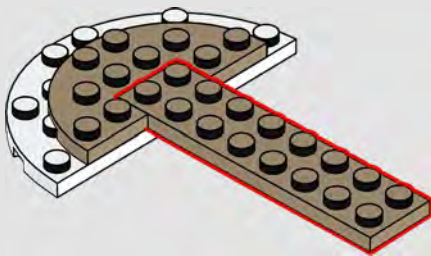

307

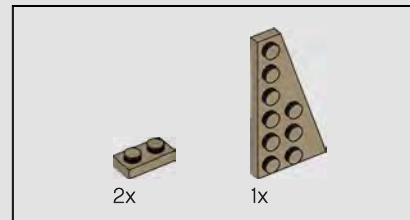

308

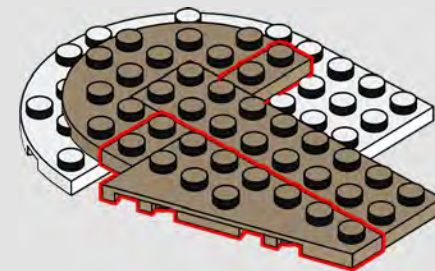
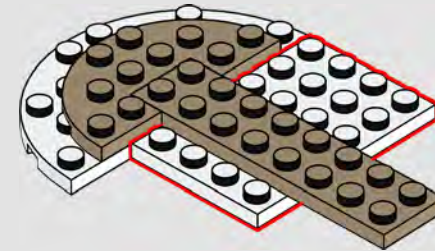

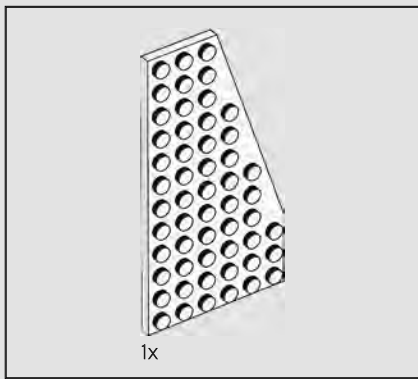

309

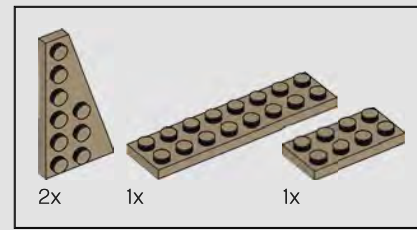
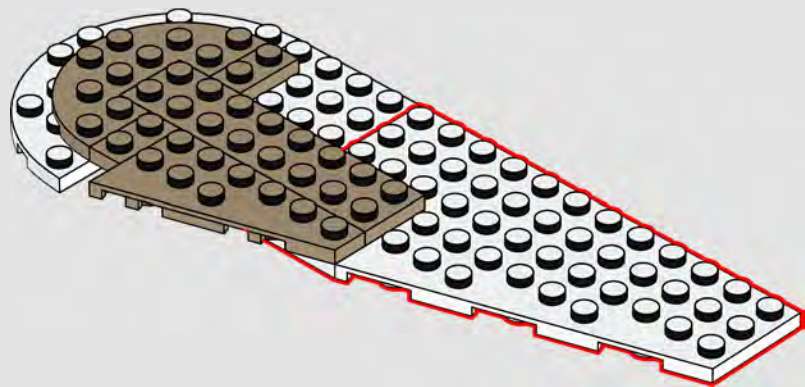

310

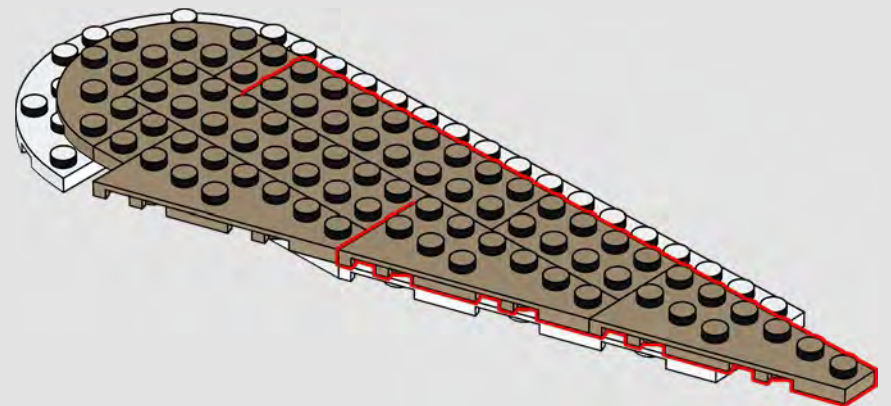

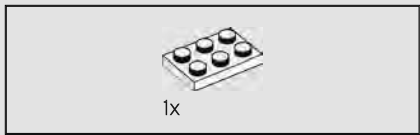

311

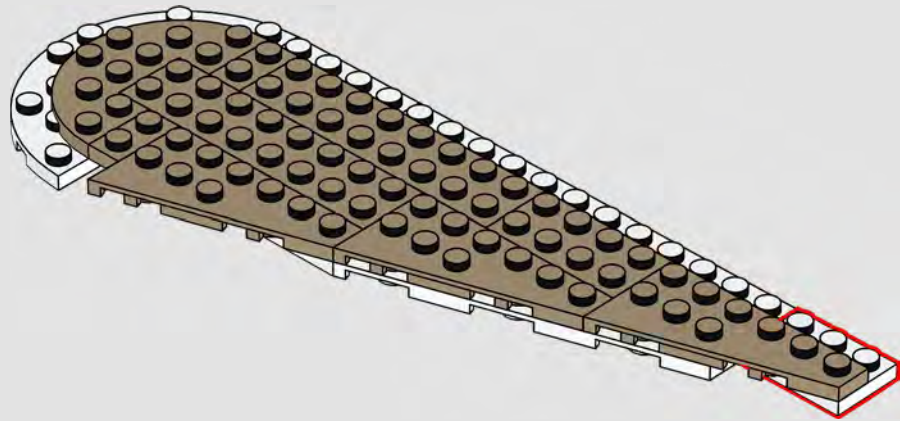

312

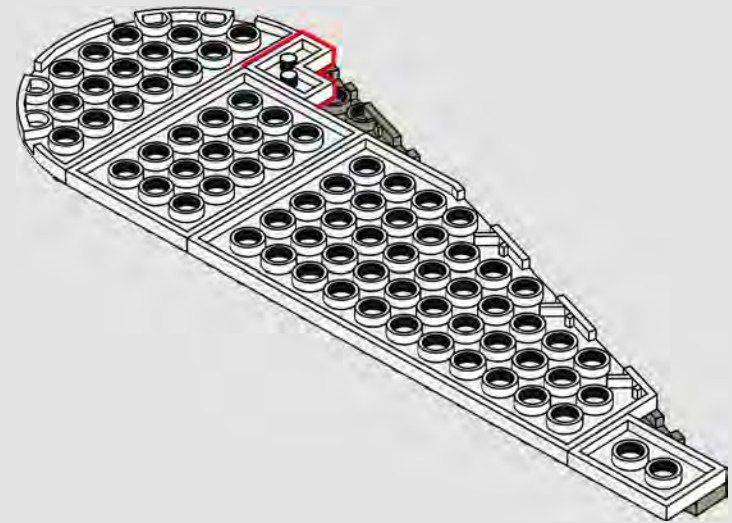
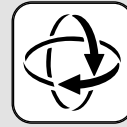

313



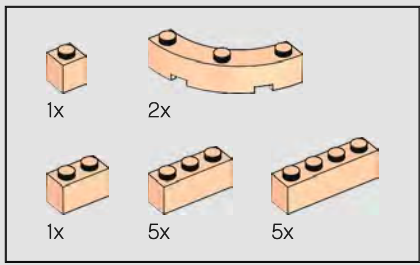

314

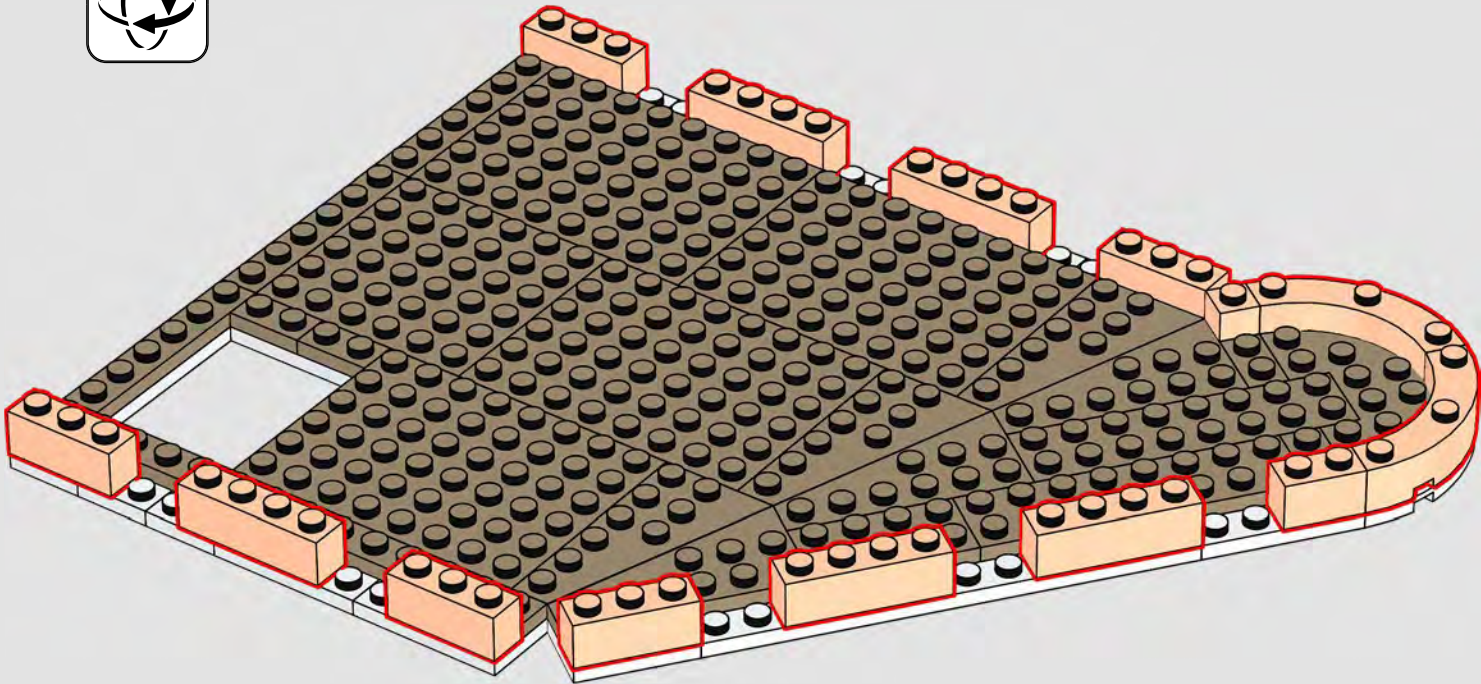

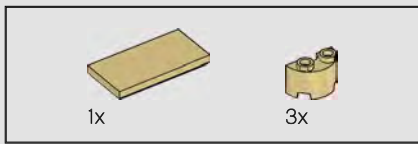

315

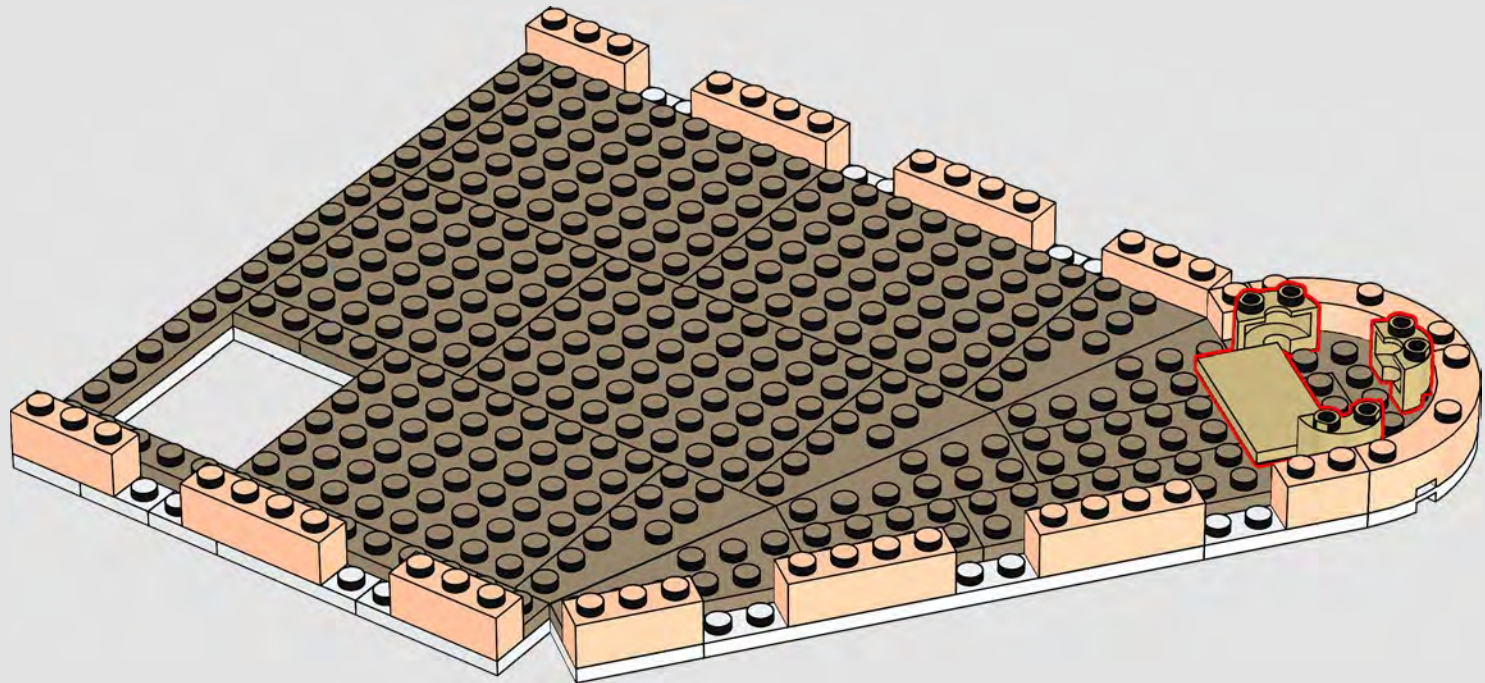



316

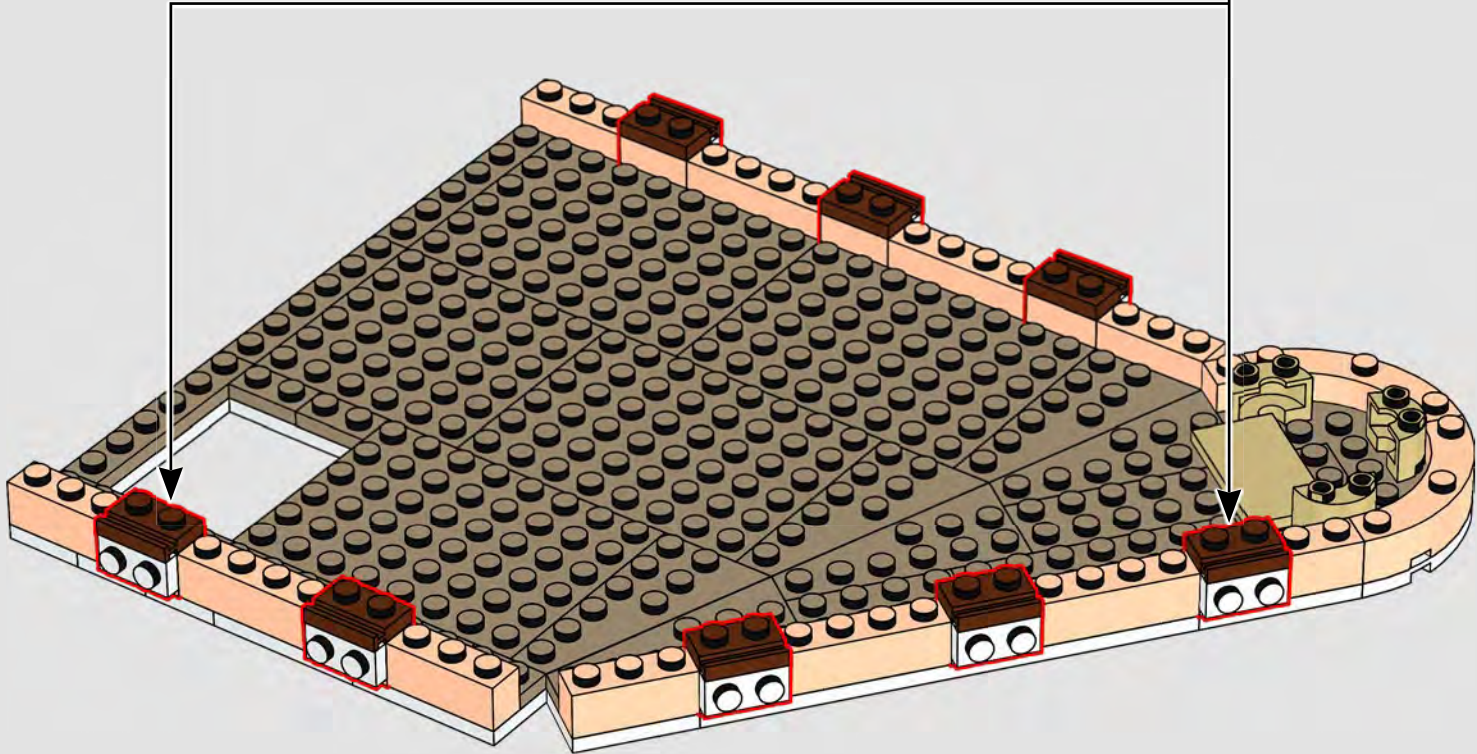
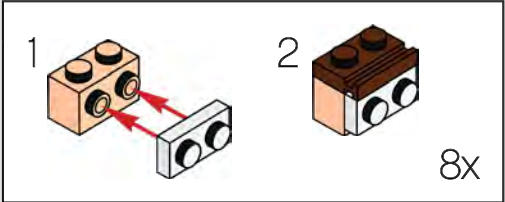

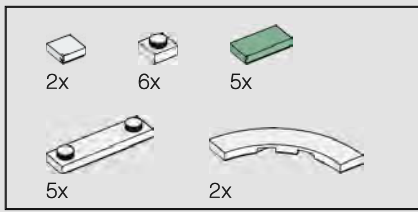

317

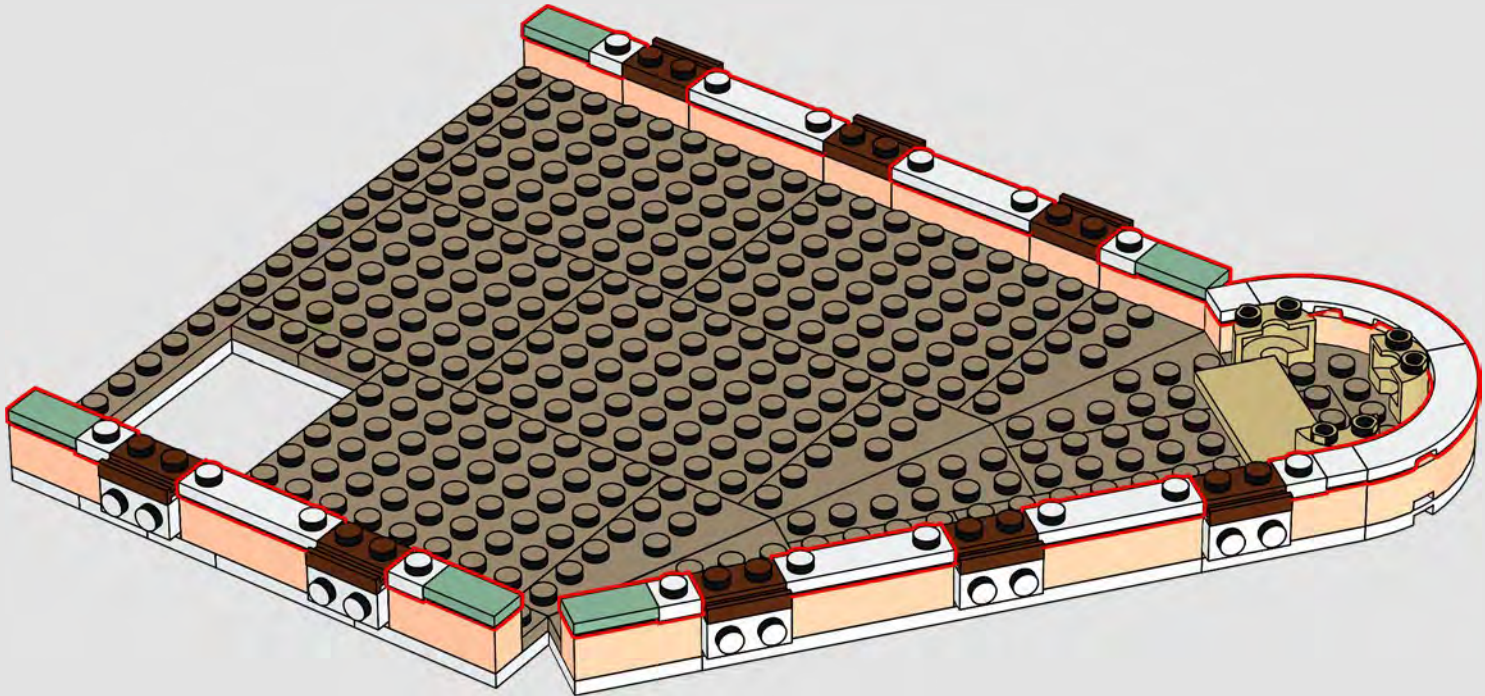

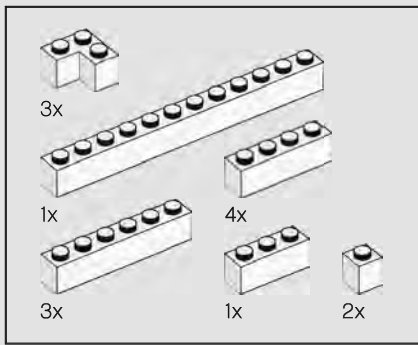

318

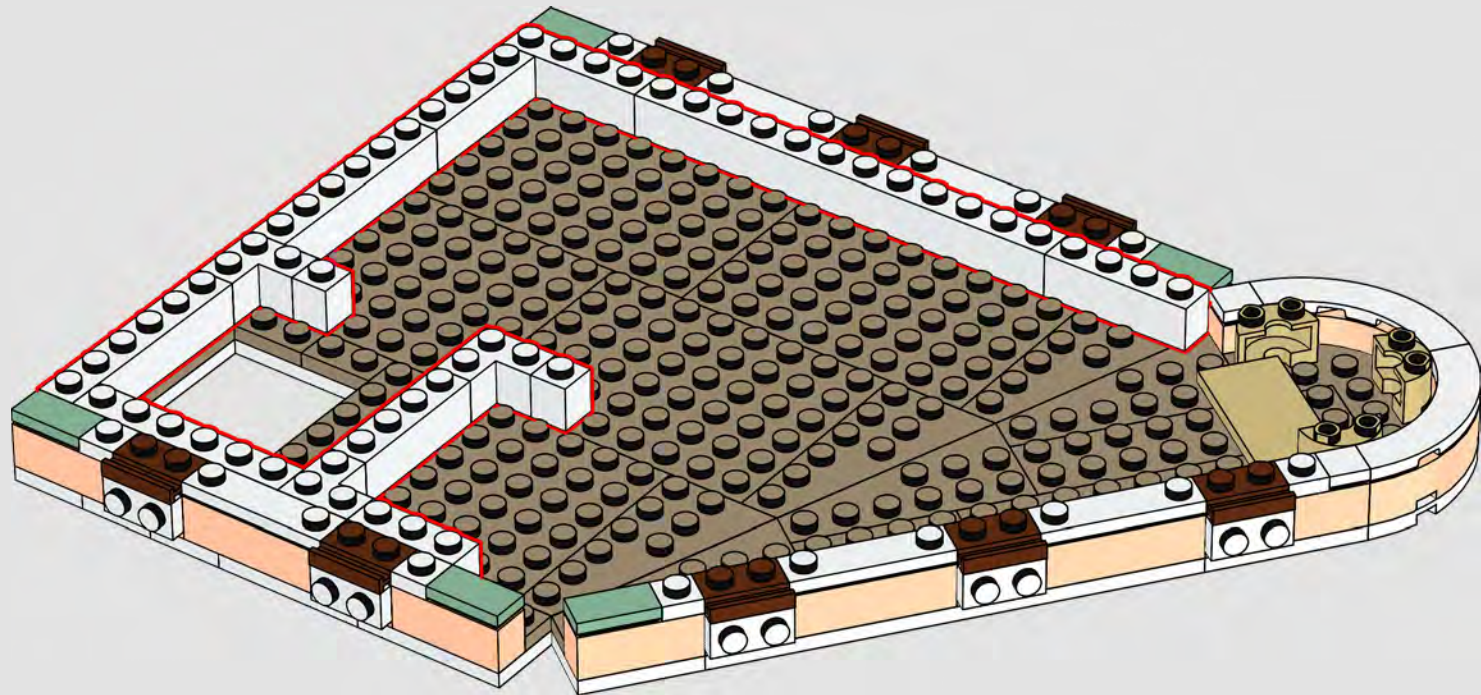

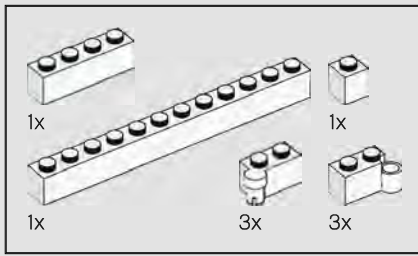

319

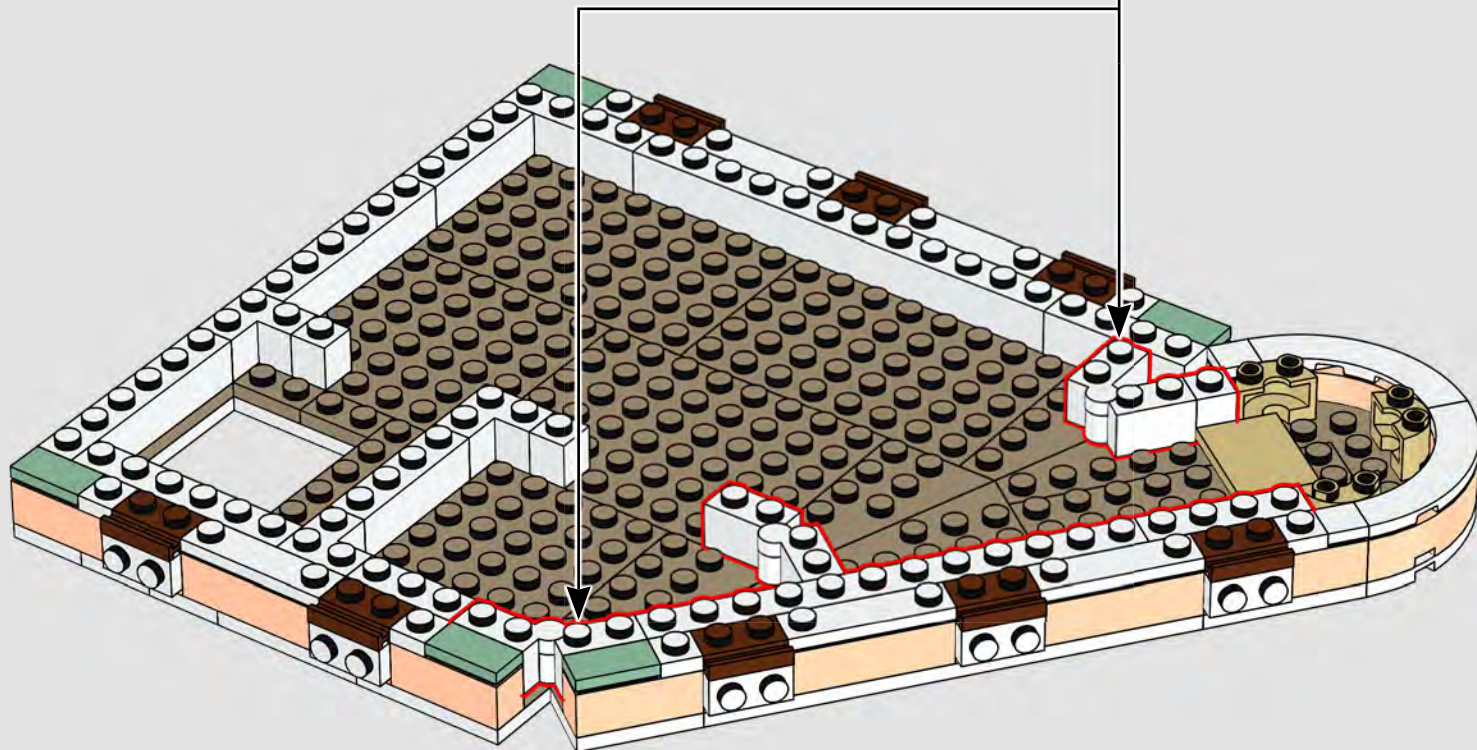
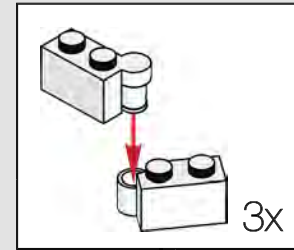

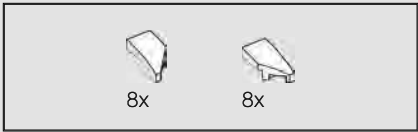

320

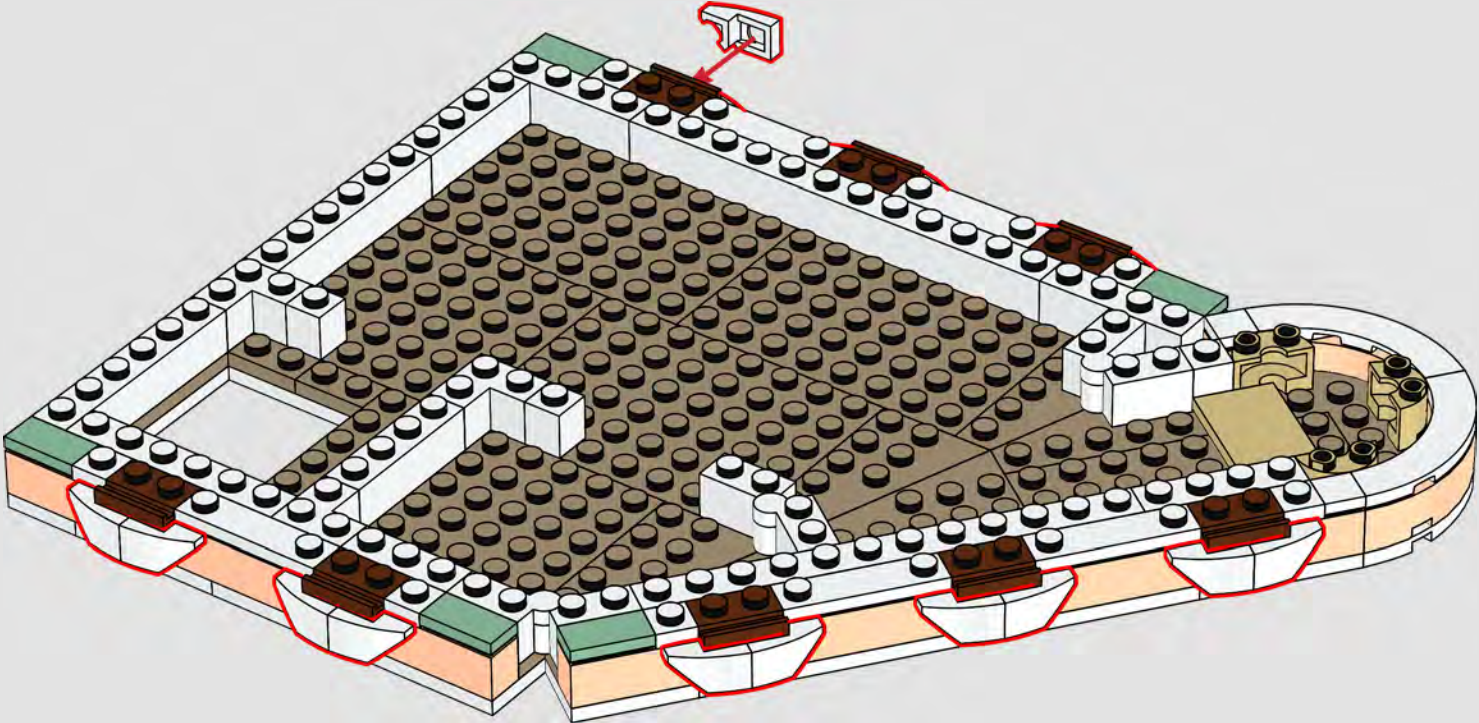



321

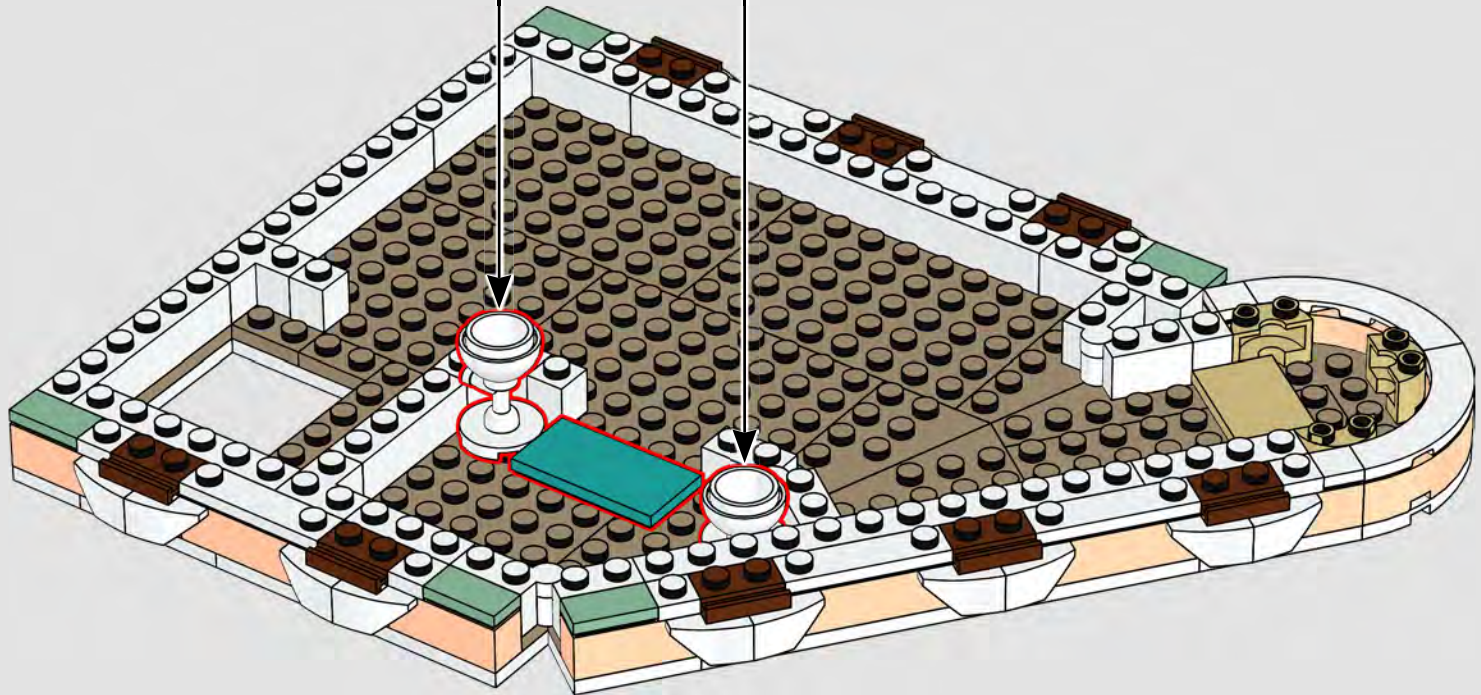

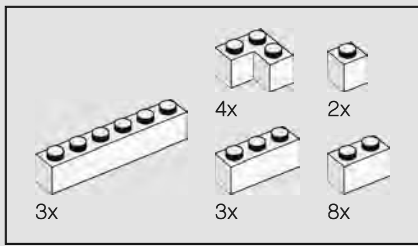

322

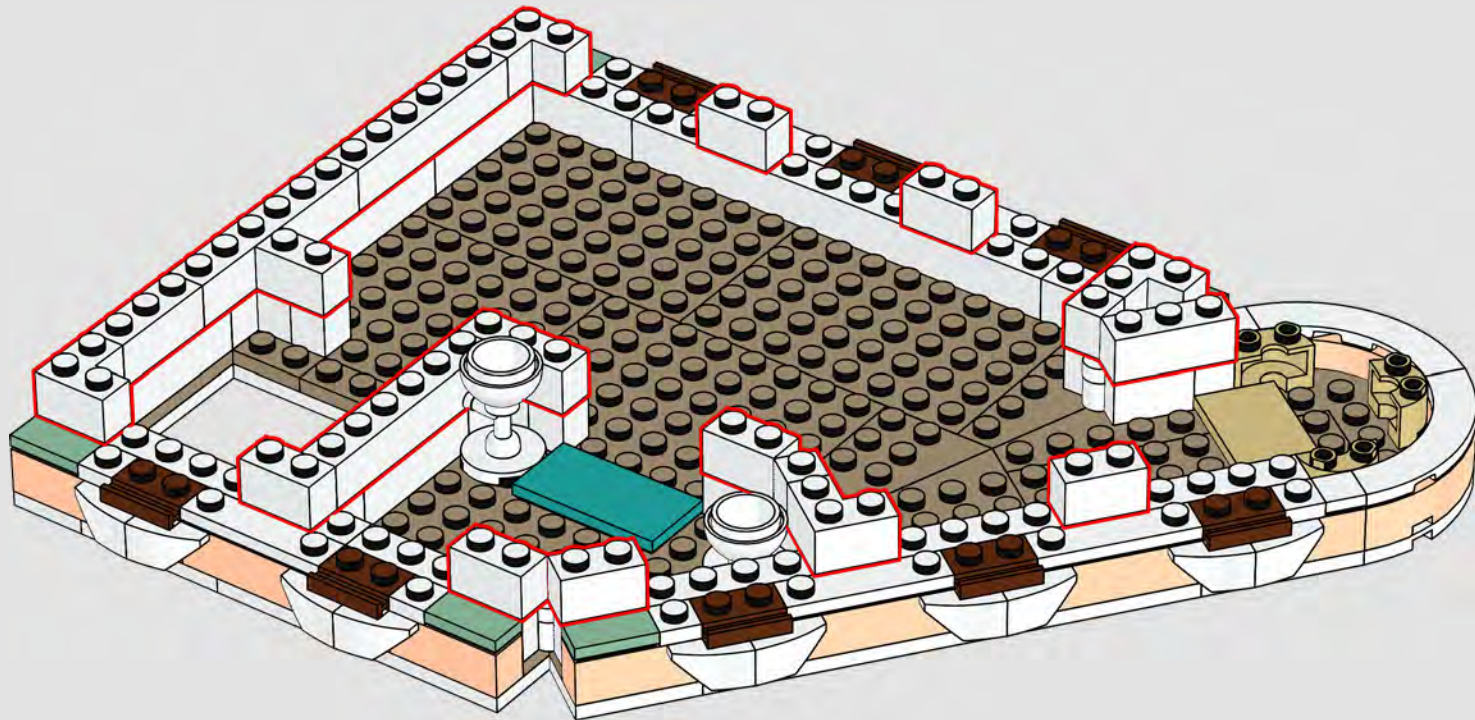

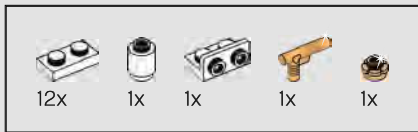

323

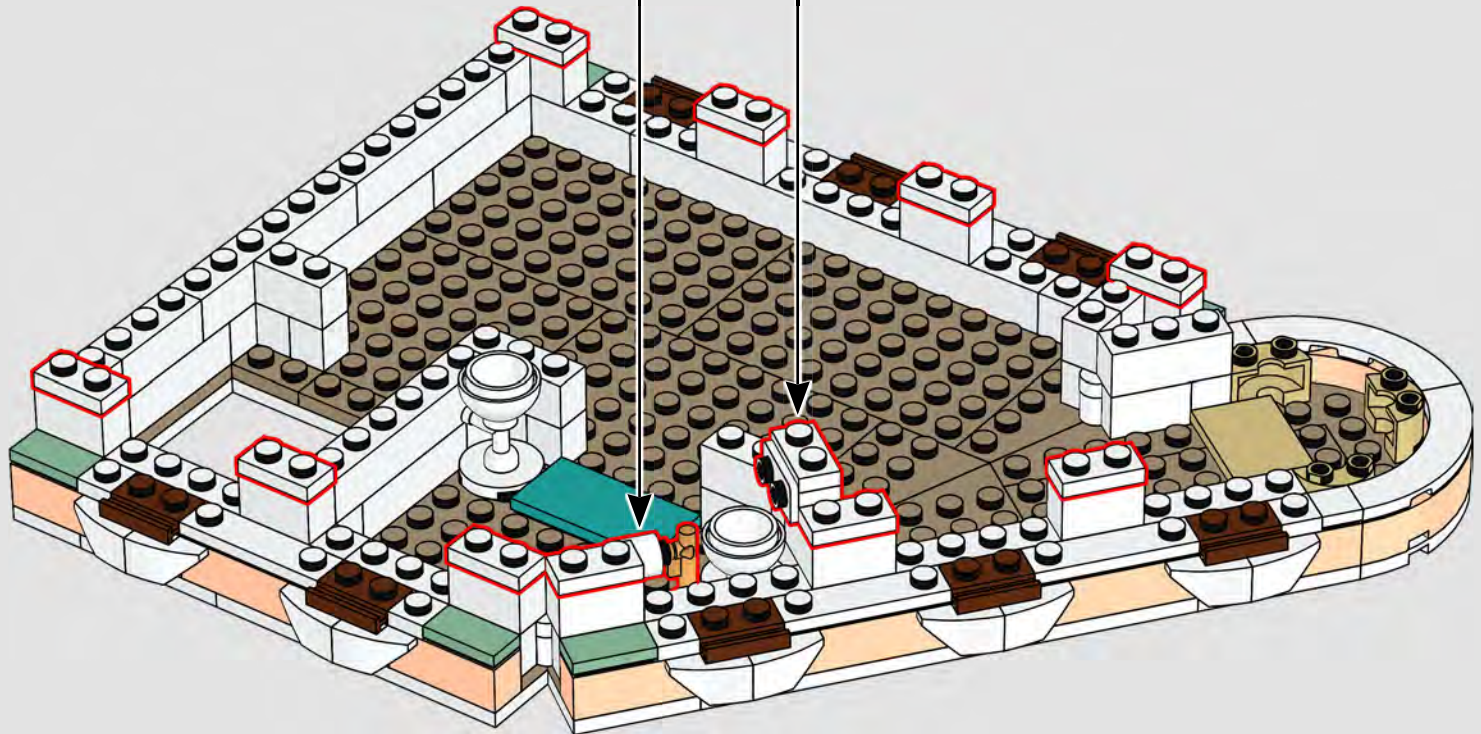
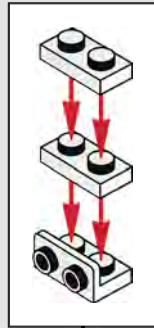
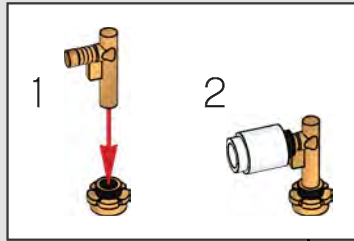

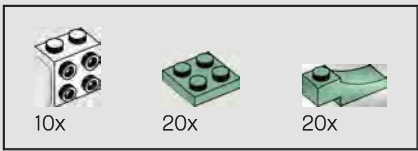

324

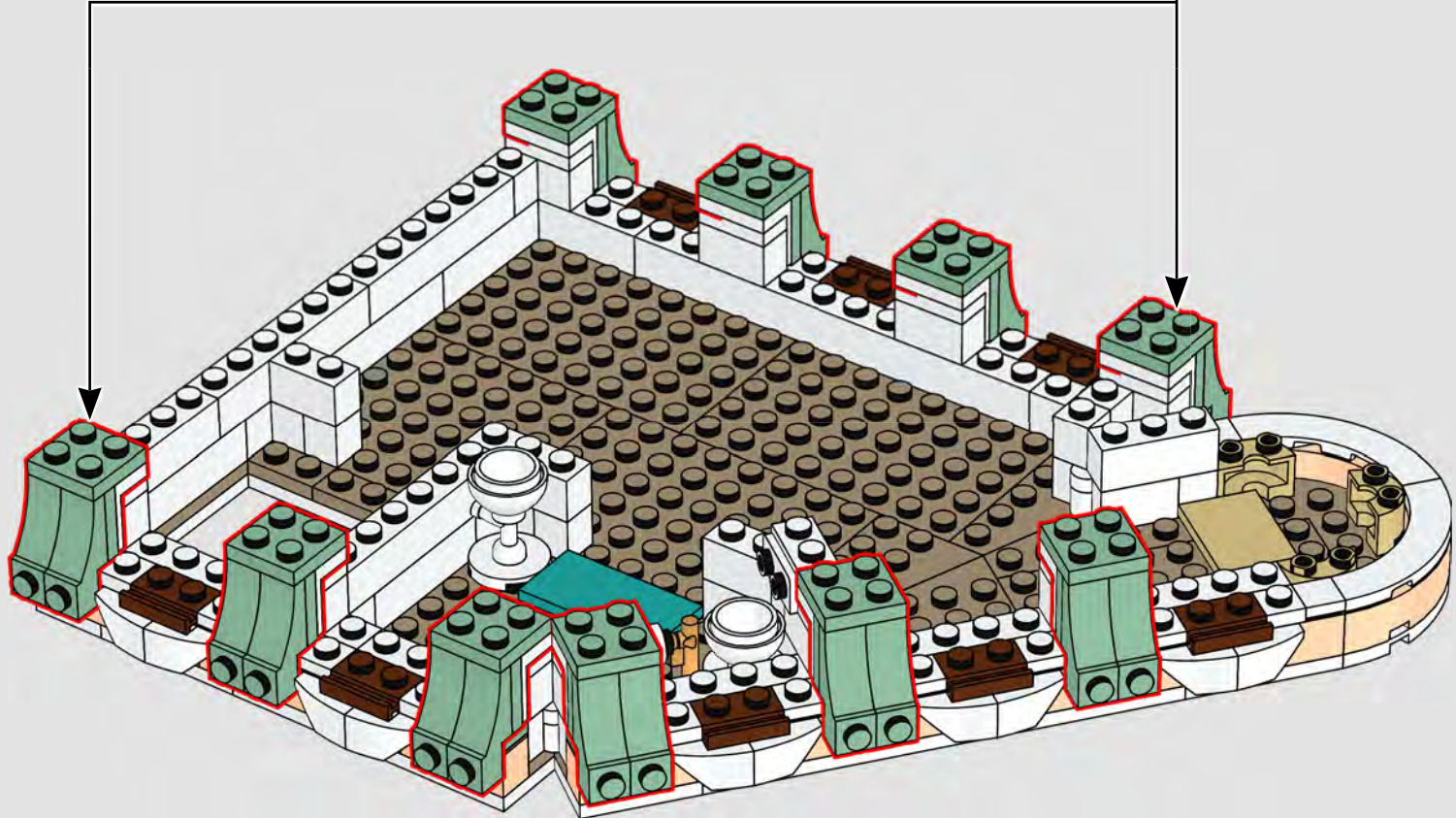
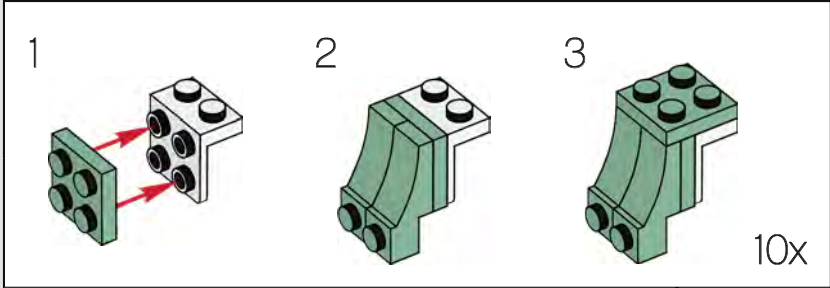

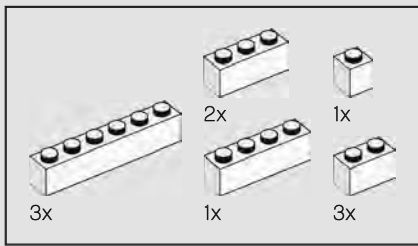

325

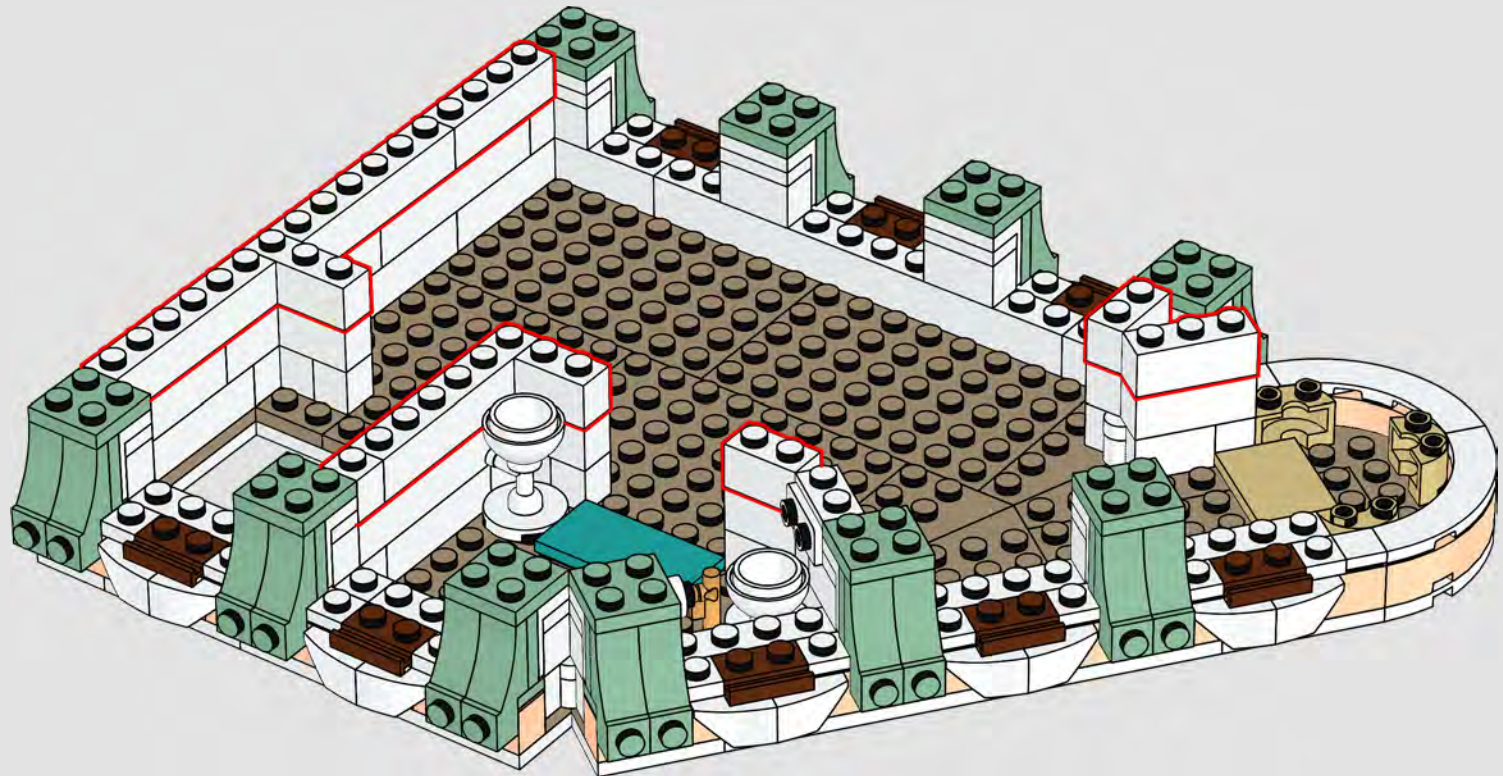

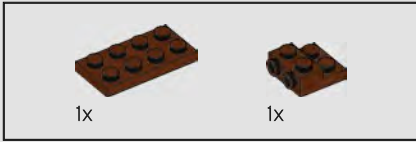

326

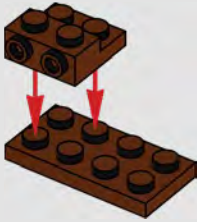

327

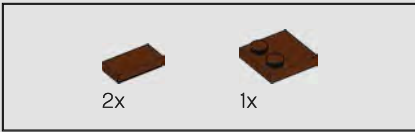
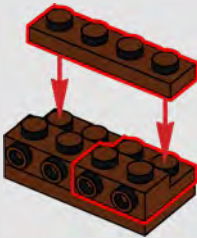

328

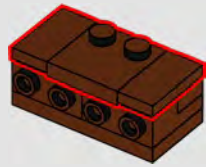

329

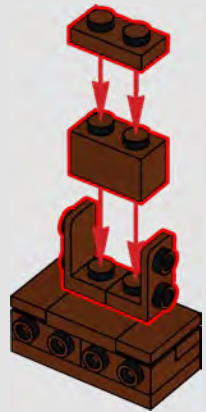

334

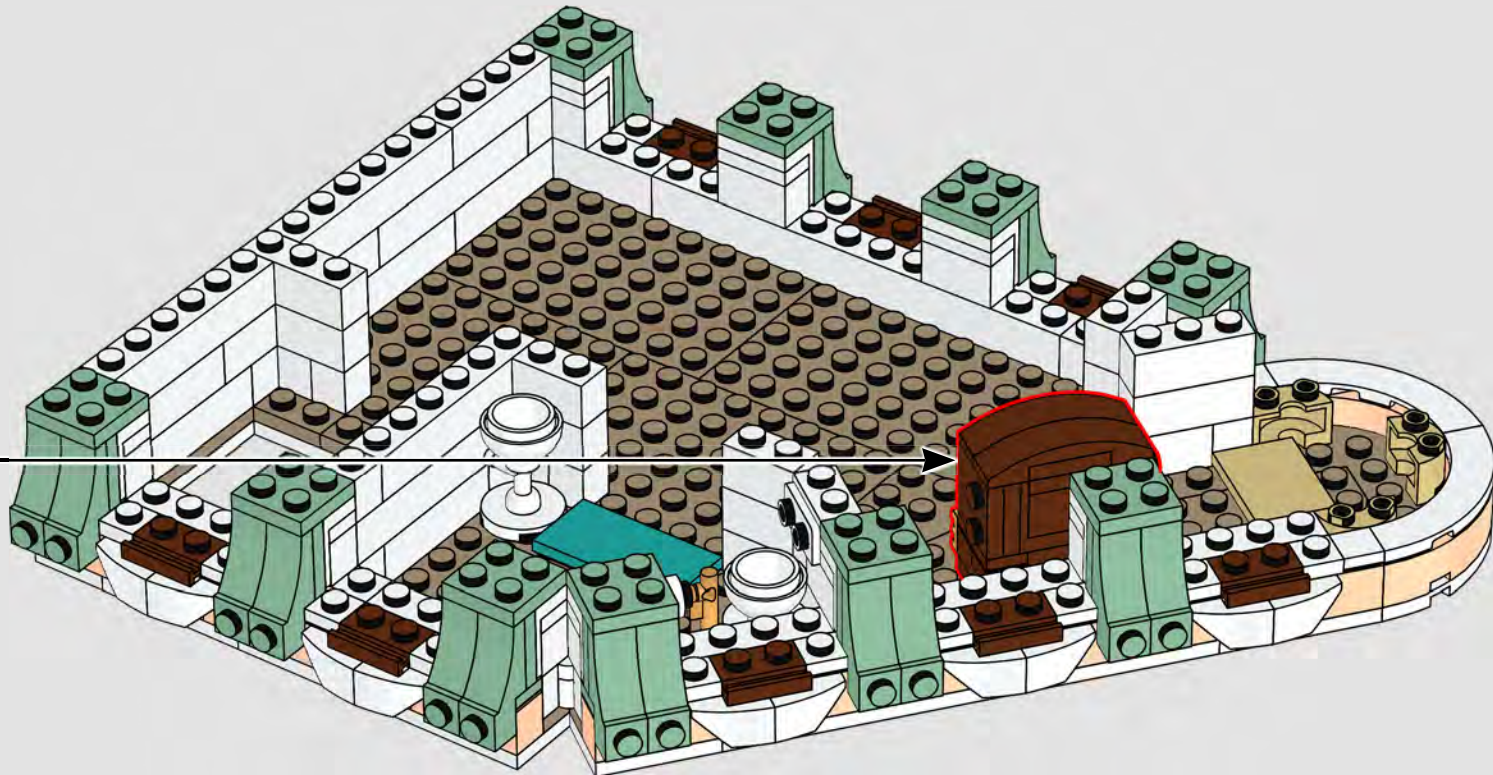



The Globetrotter has been all over the world, but always loves to come back to the Boutique Hotel for a relaxing stay.

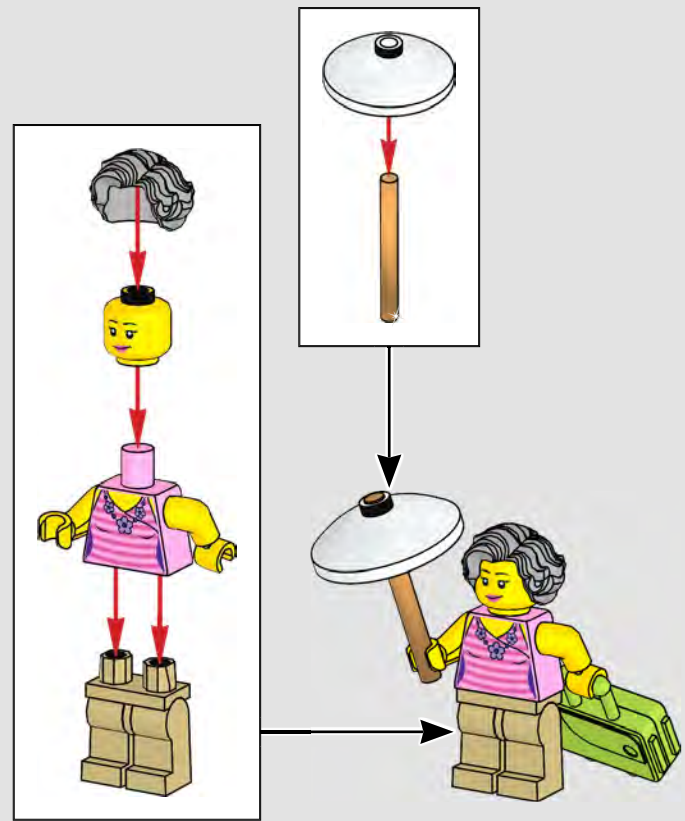
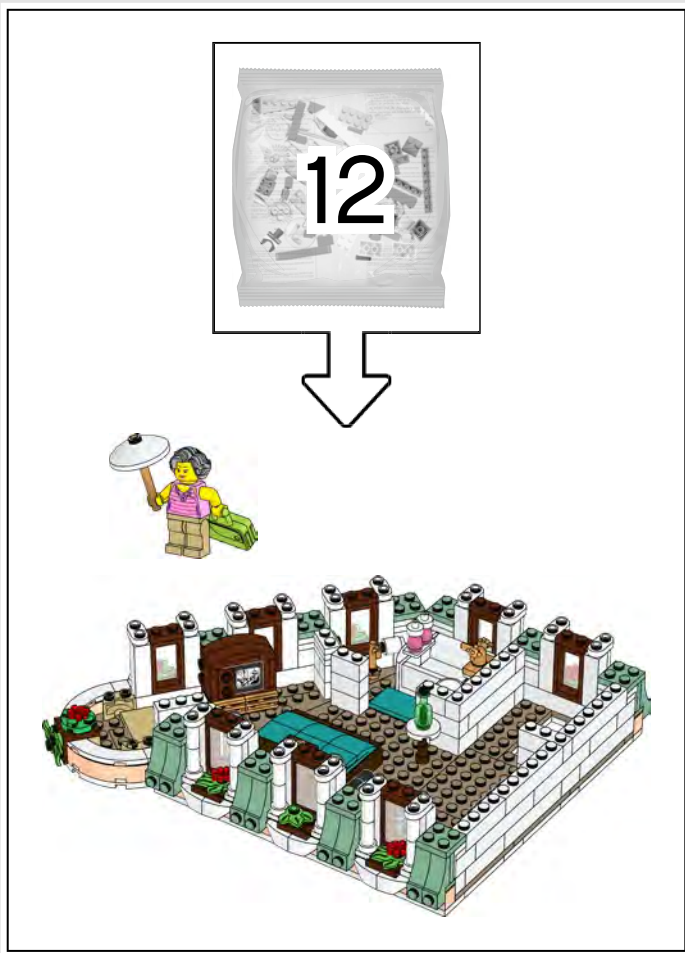

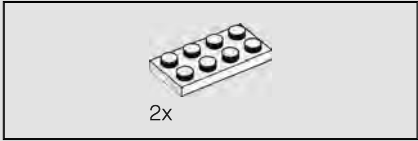

2x

335

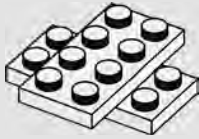

4x

336

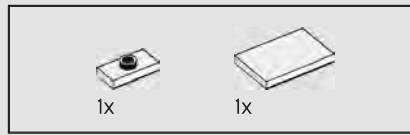
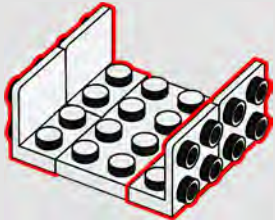

1x

1x

337

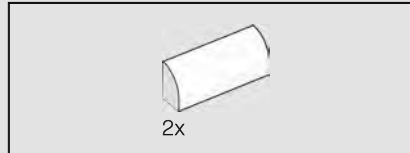
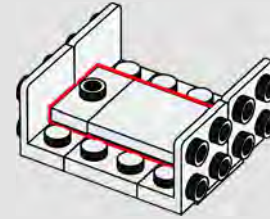

2x

338

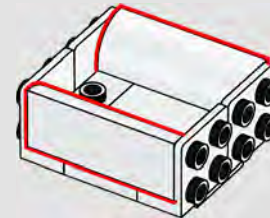

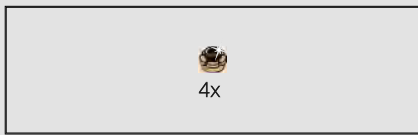

339

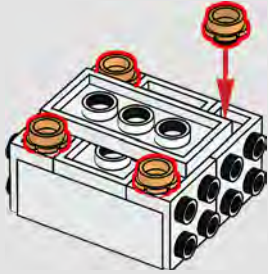

340

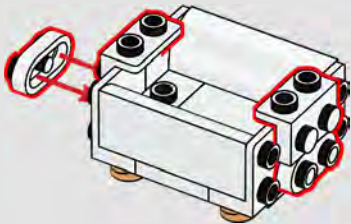

341

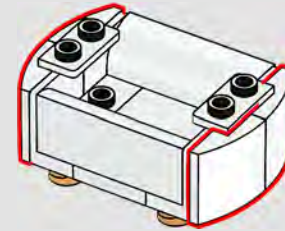

342

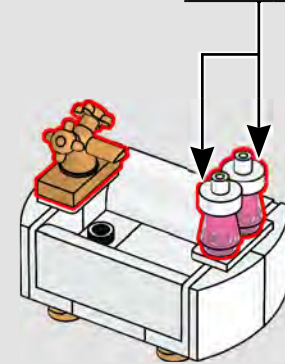

343

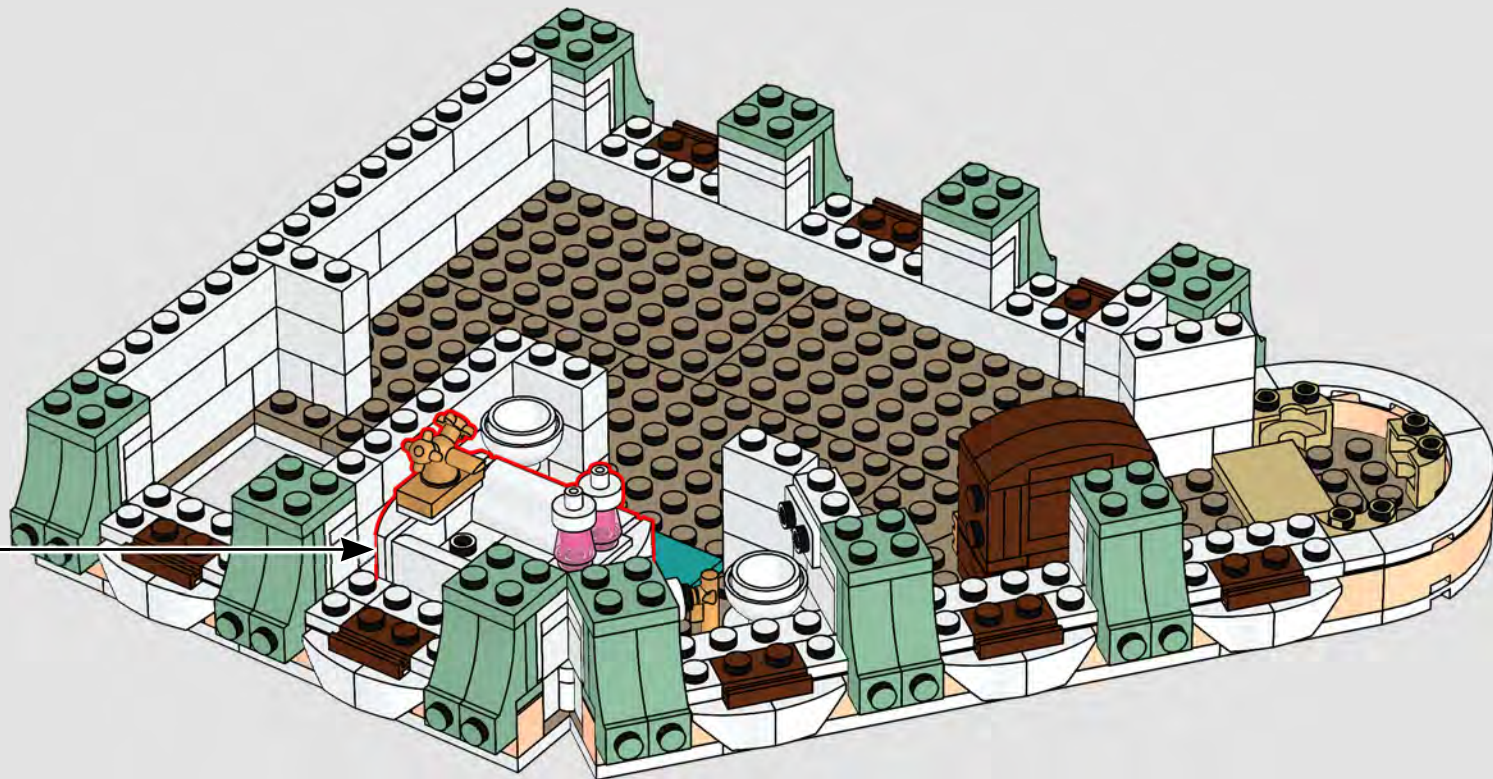

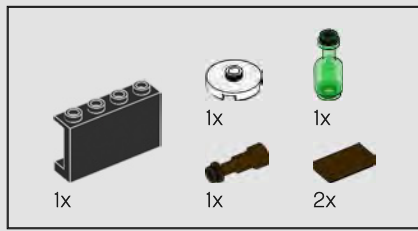

344

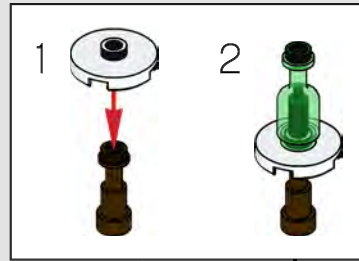

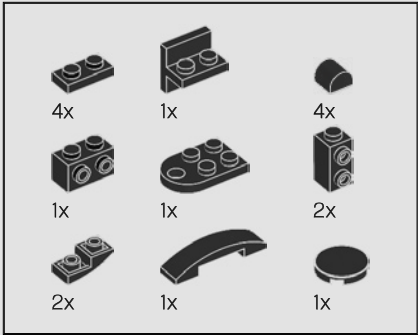

345

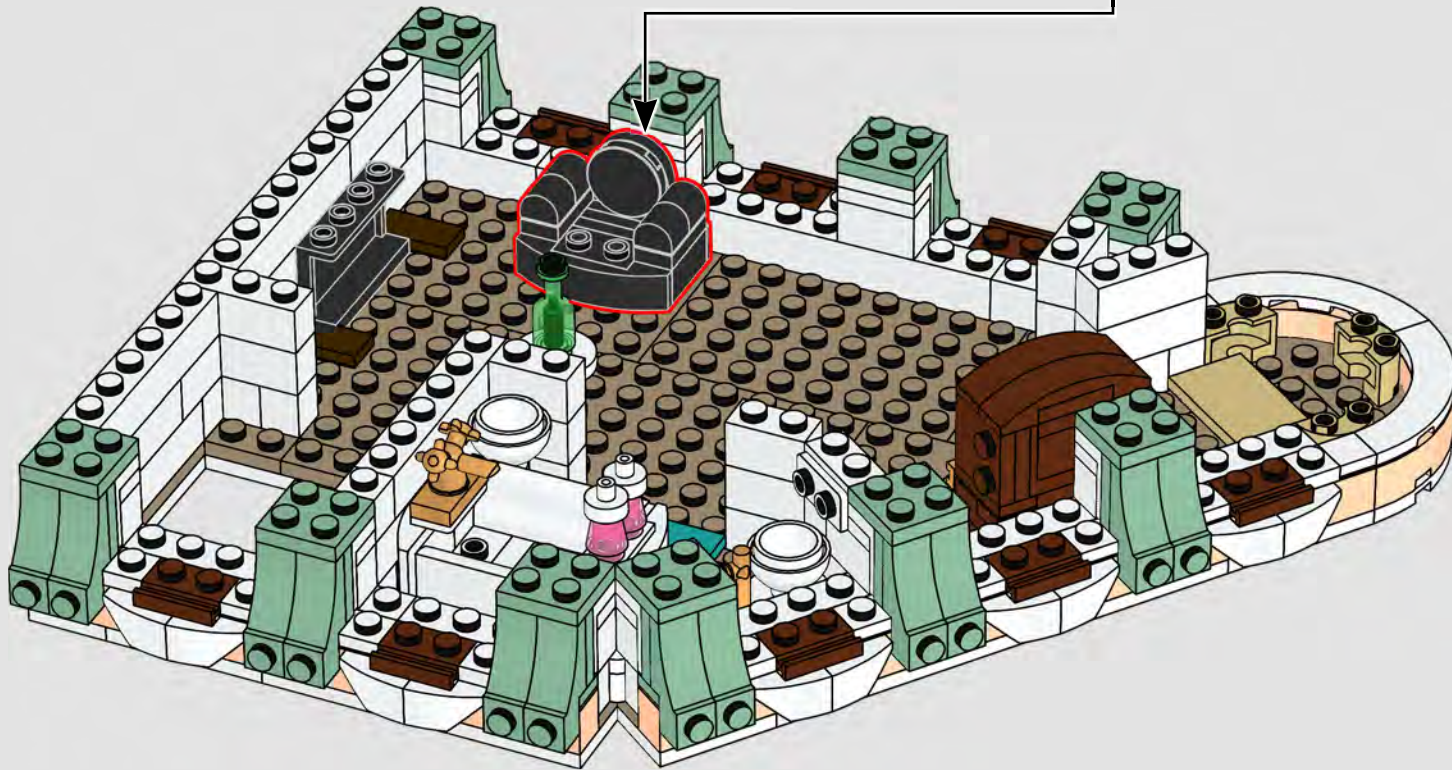
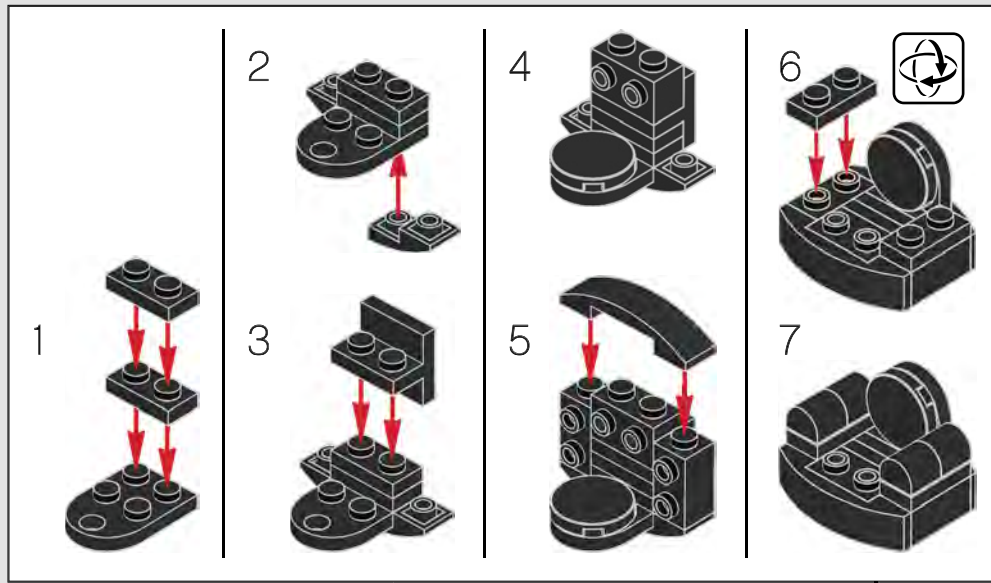



The lampshade element here is actually a cupcake element from LEGO® Friends.

346

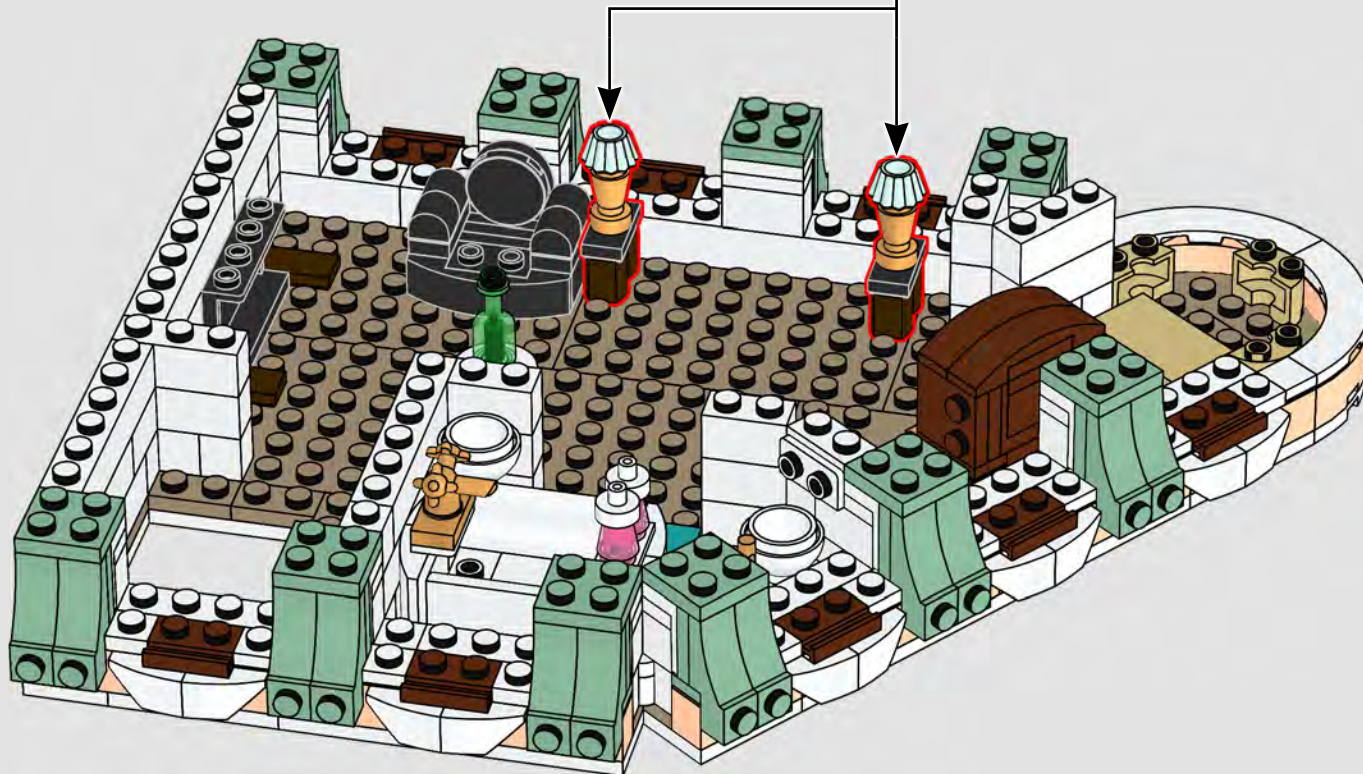
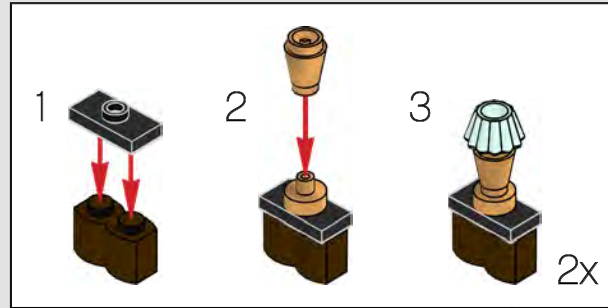

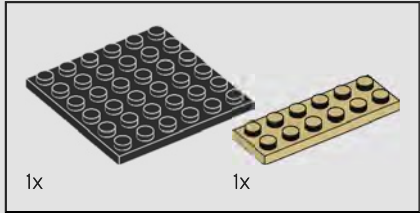
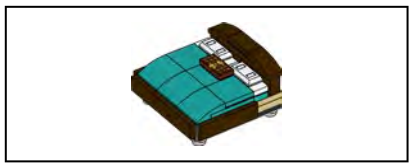

347

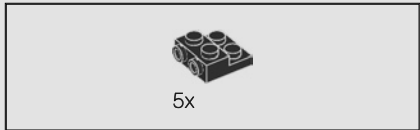
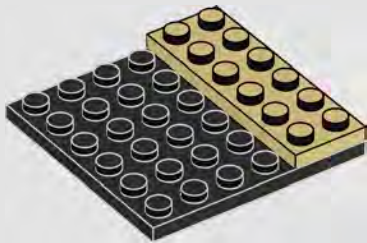

348

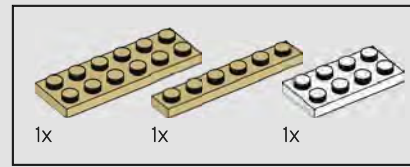
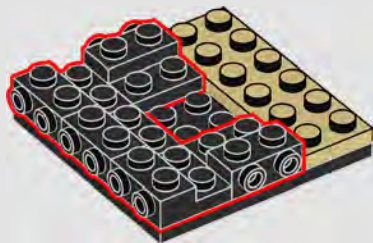

349

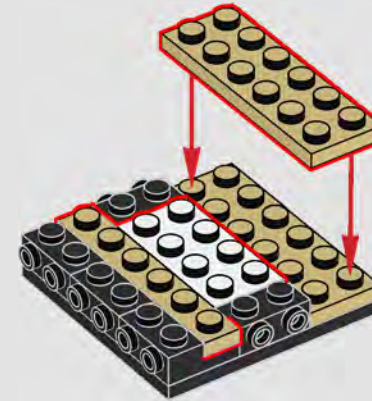

350

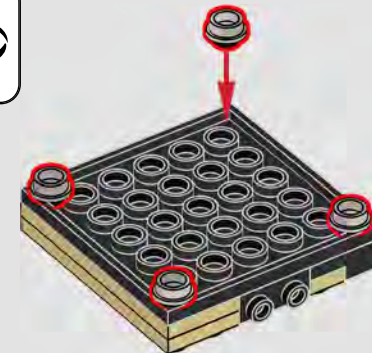
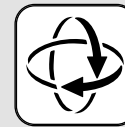

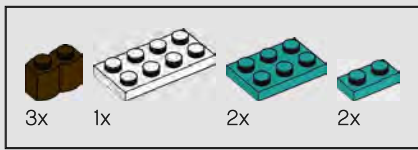

351

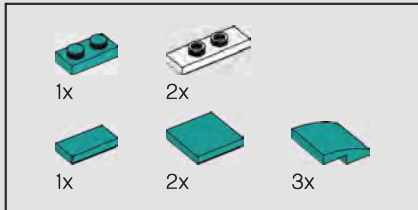
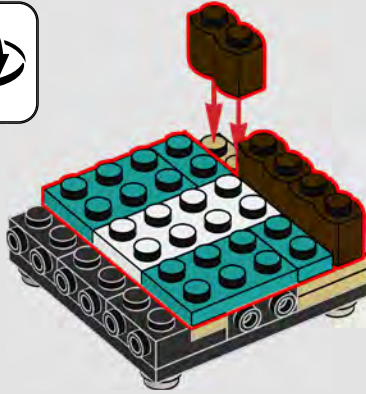

352

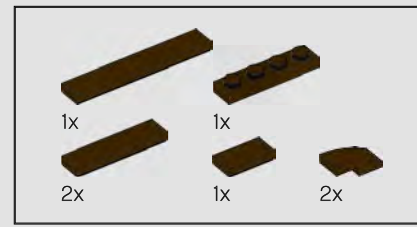
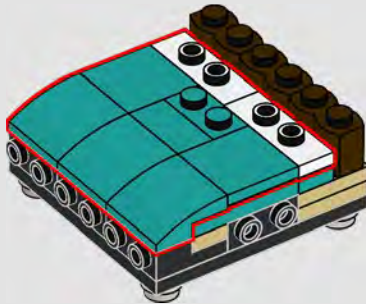

353

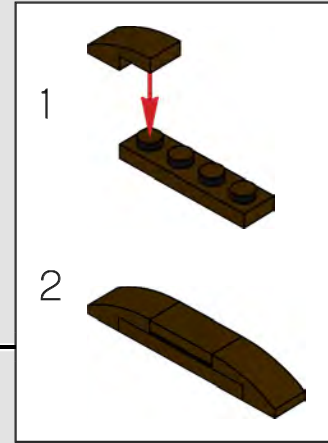
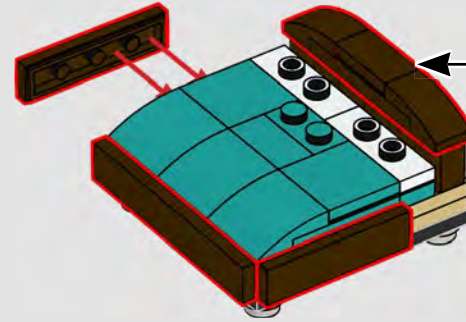

354

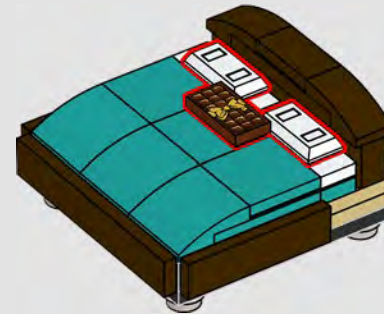

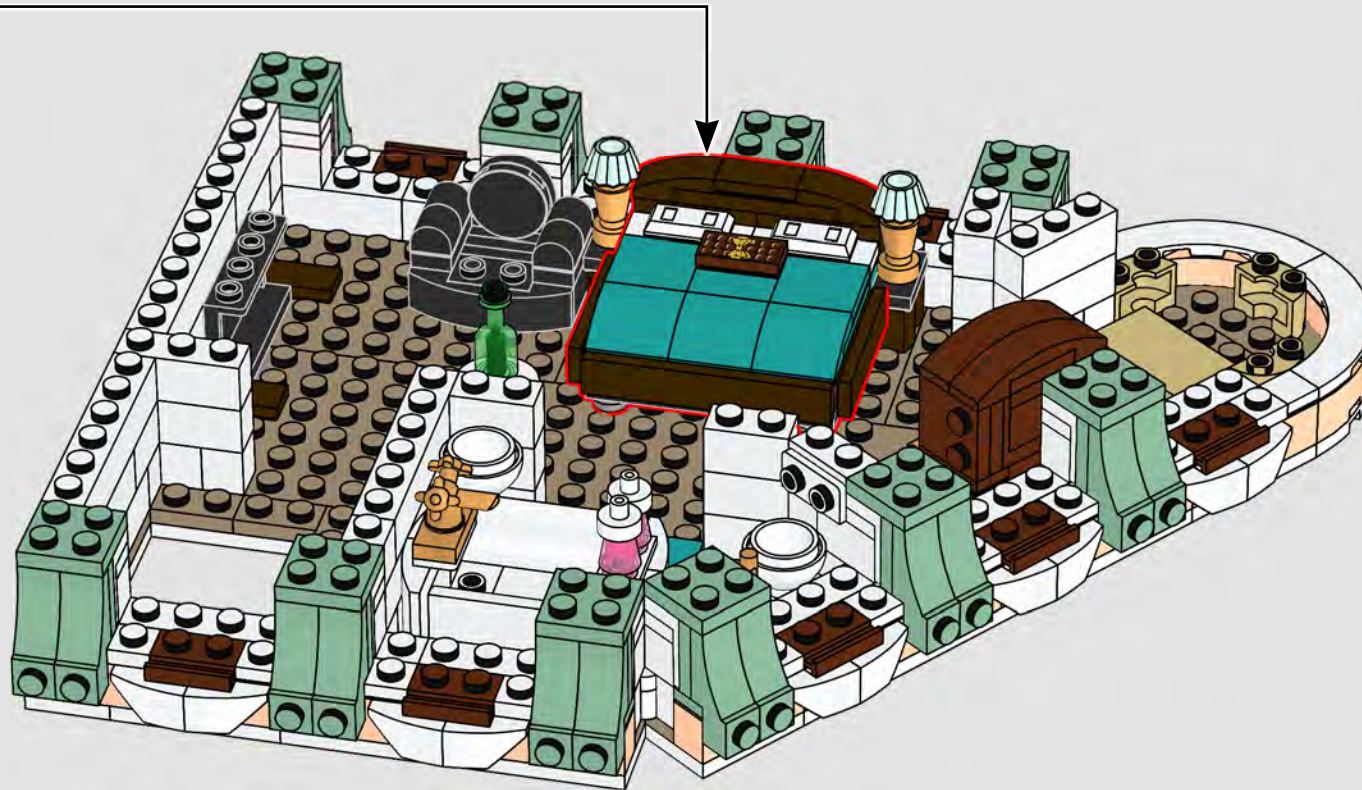



356

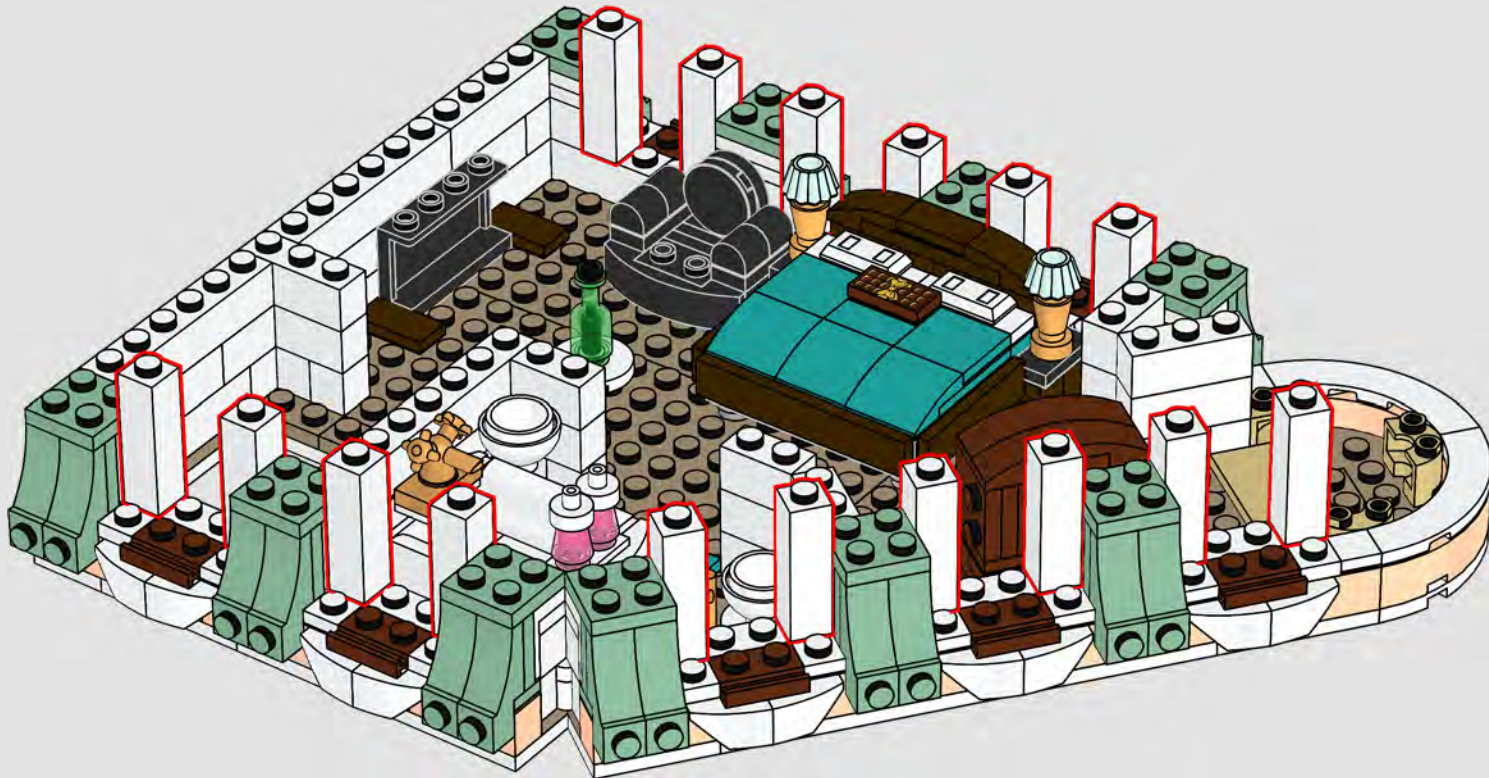



357

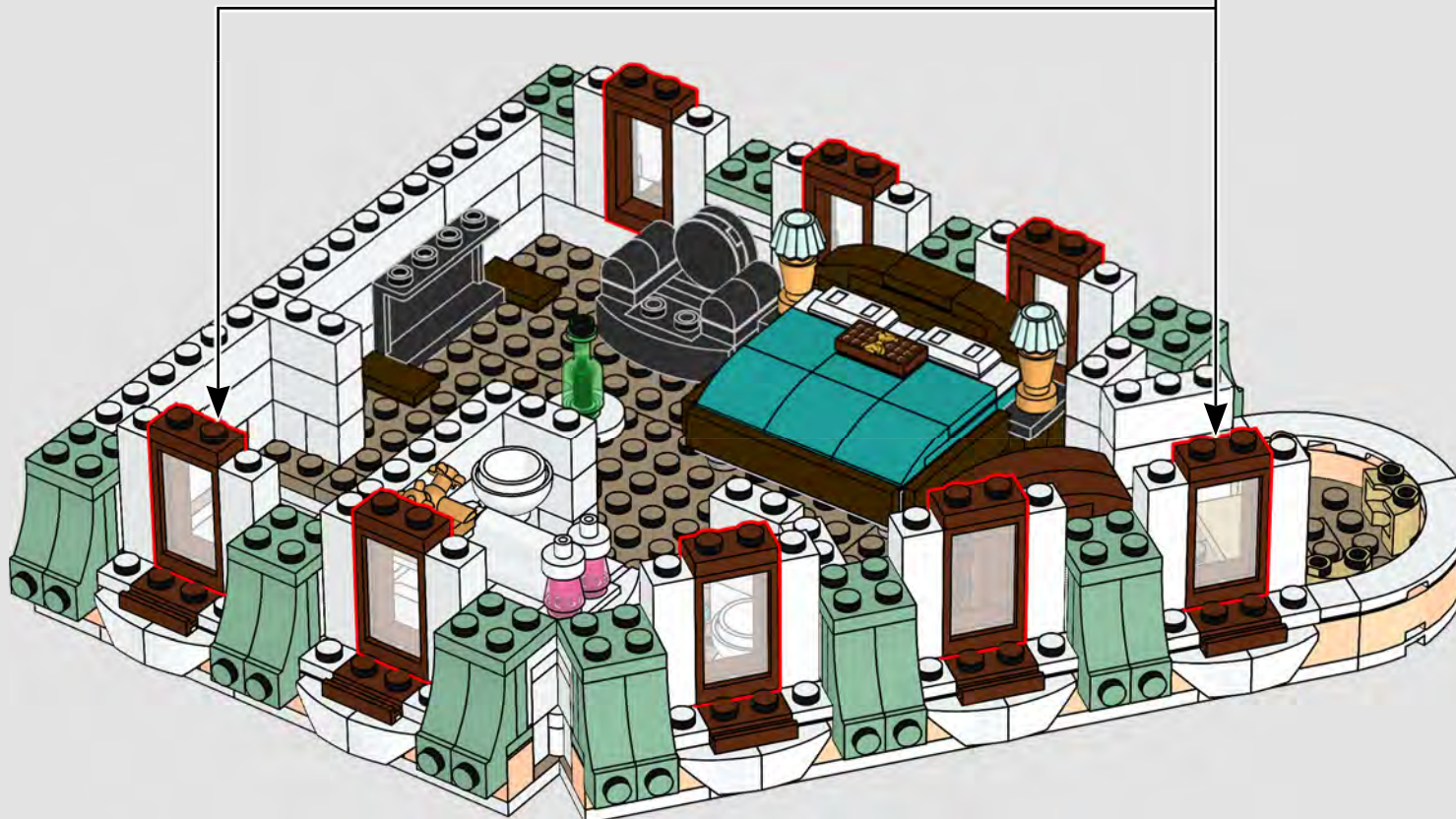
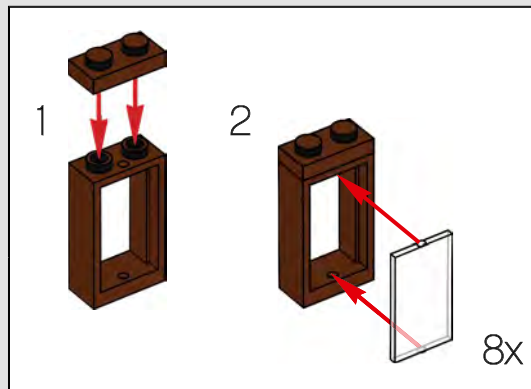



358

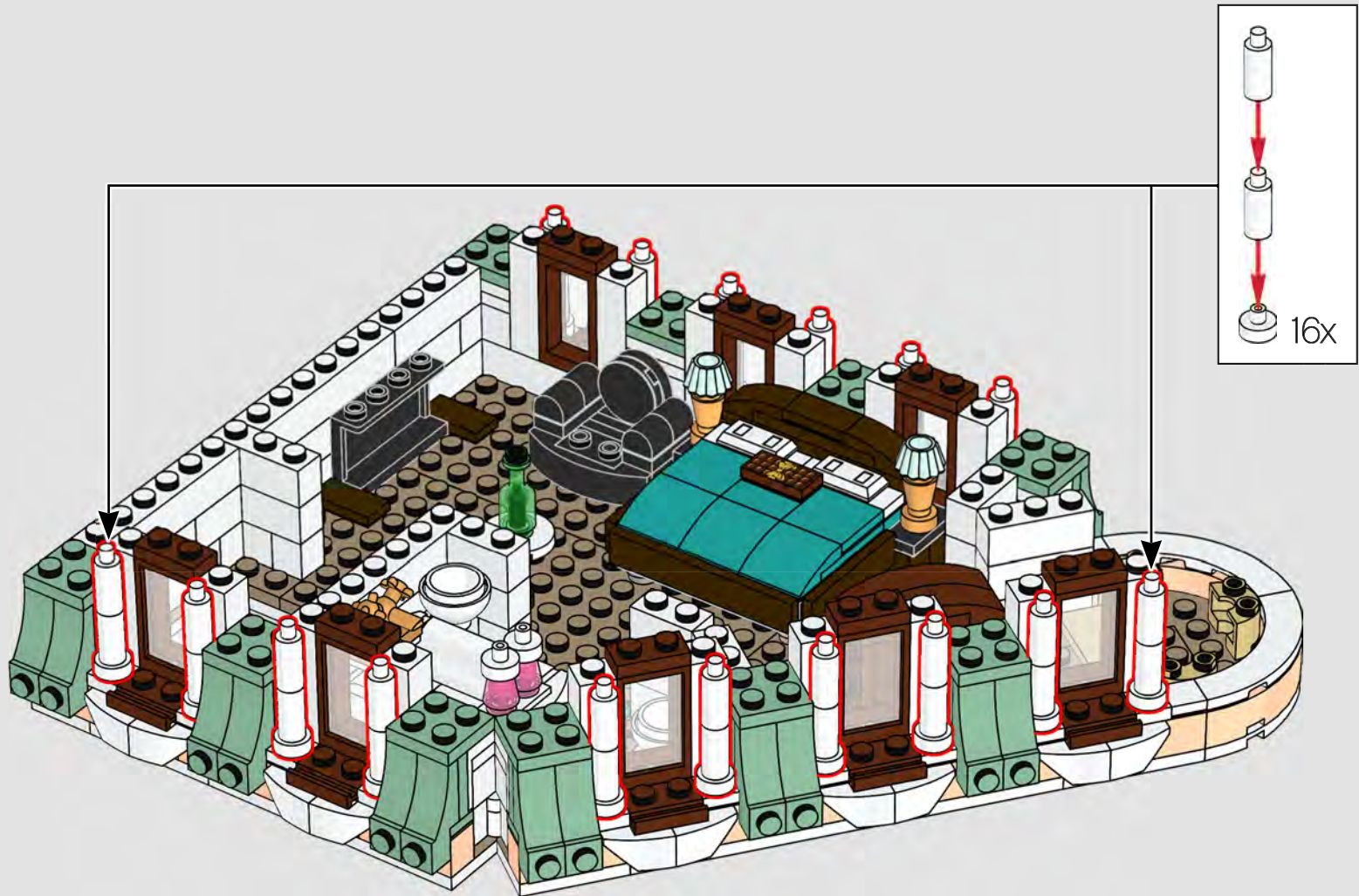



16x

359

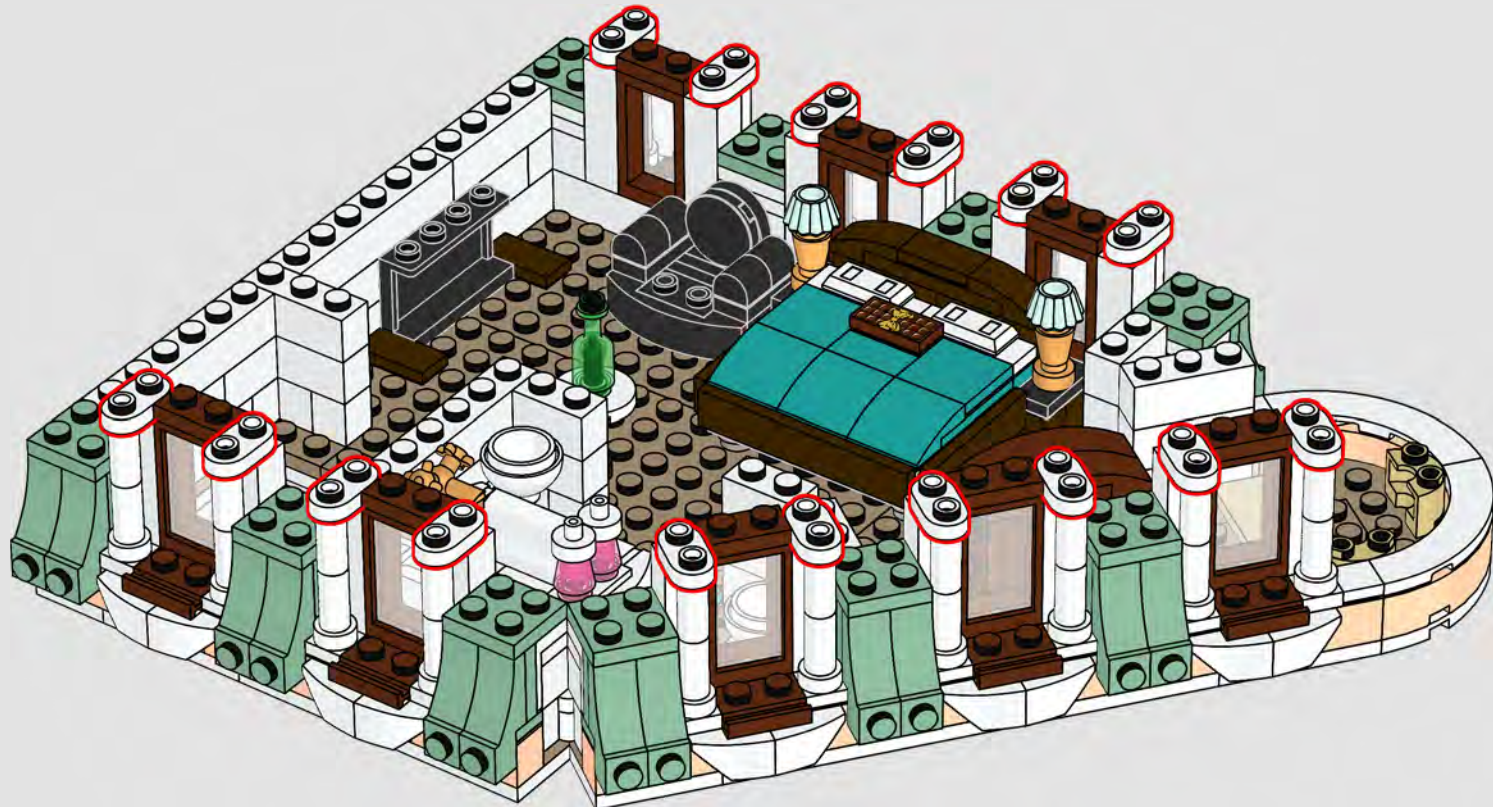

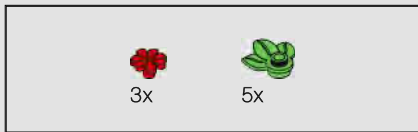

360

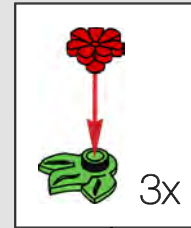

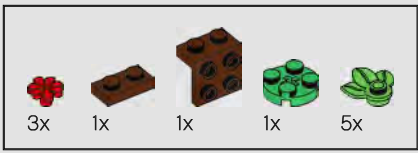

361

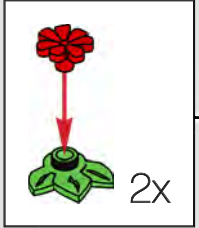
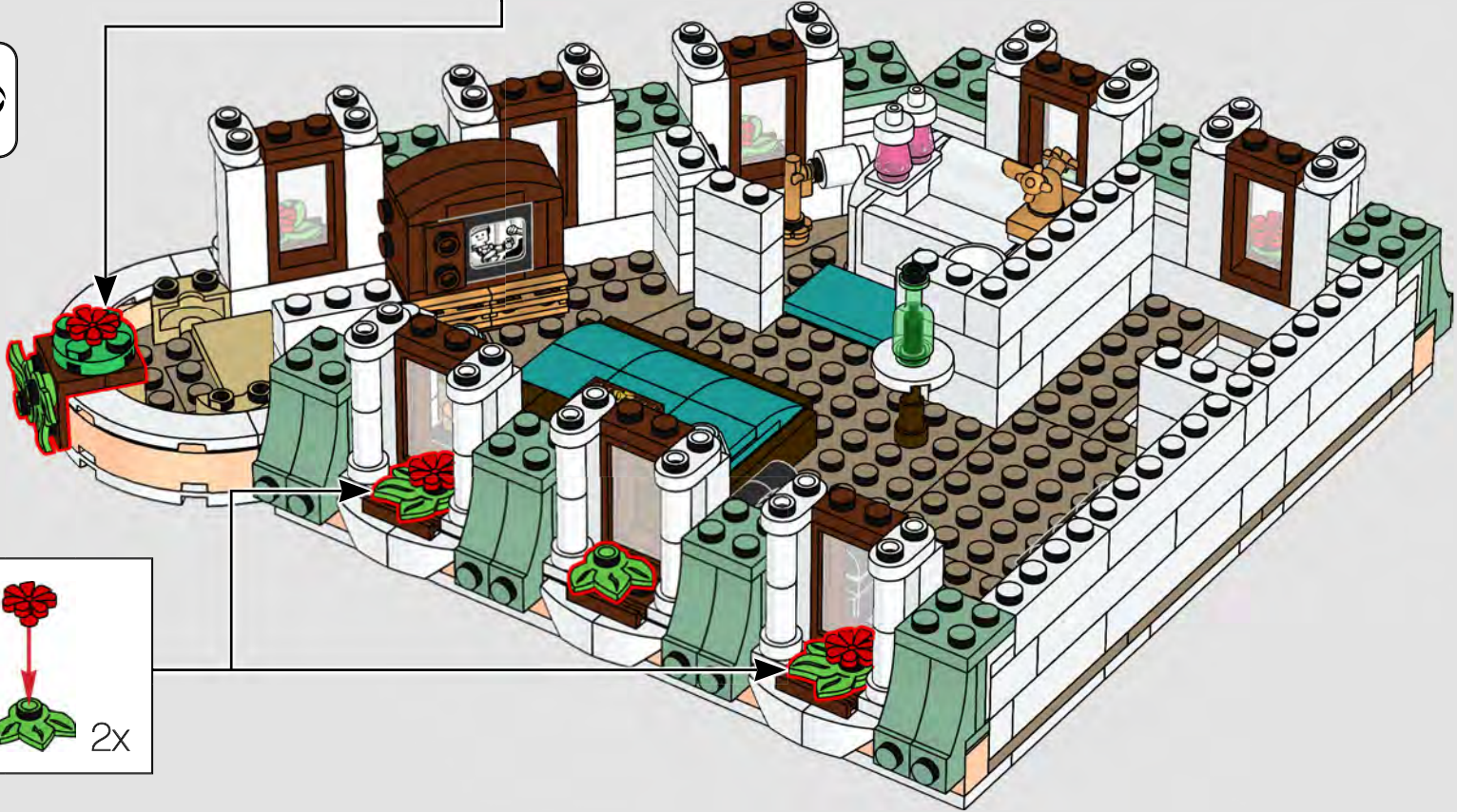
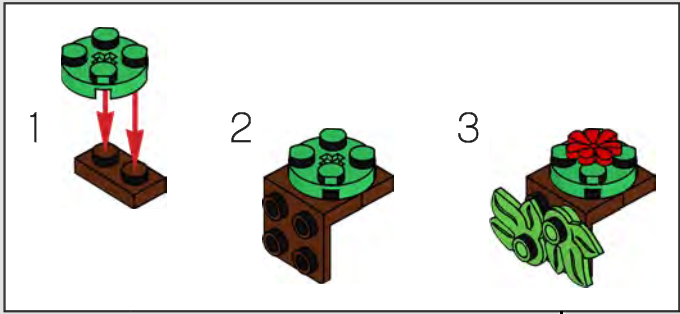

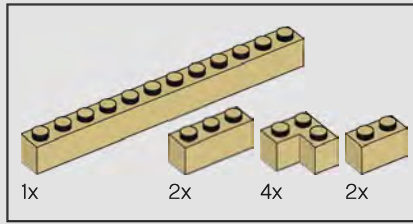
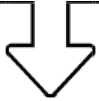

362

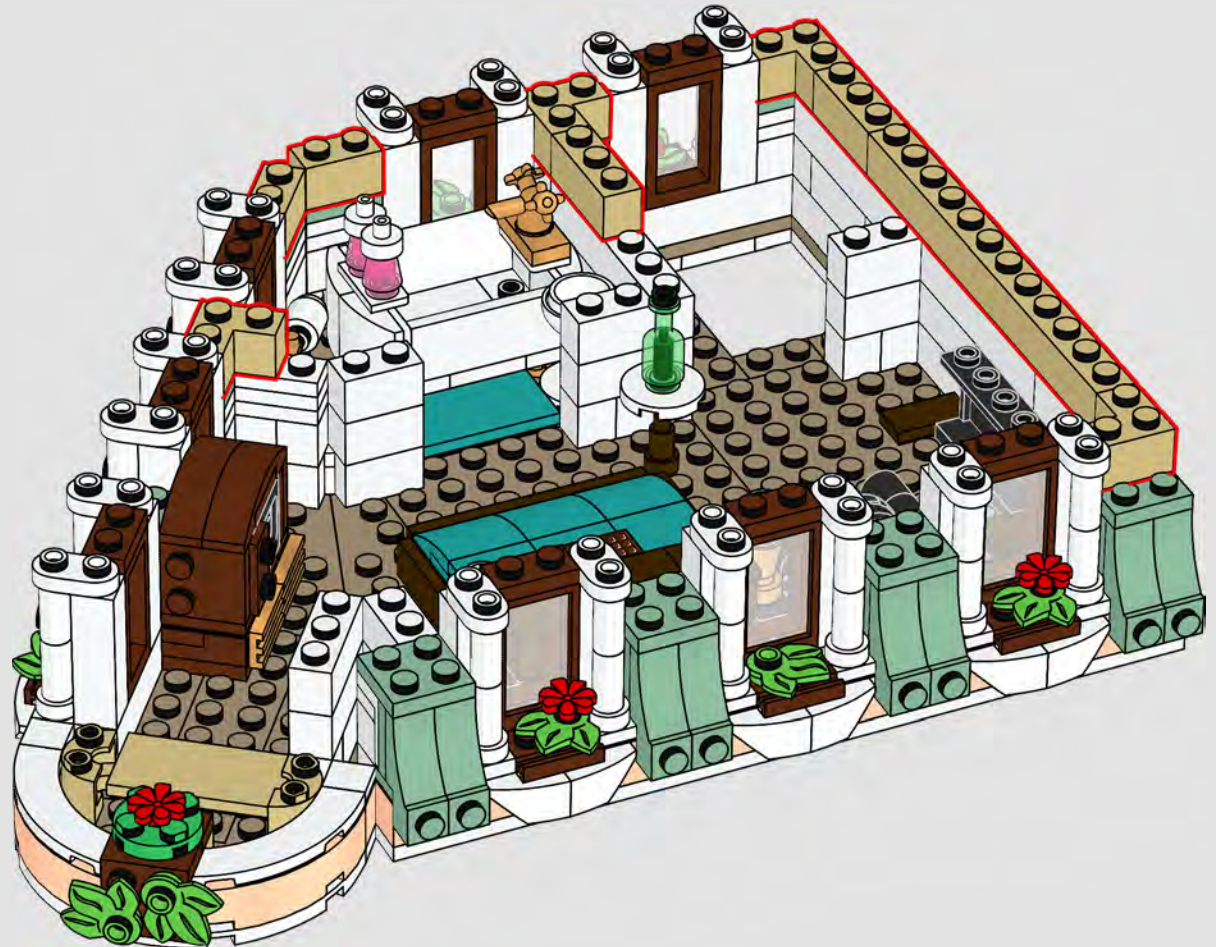

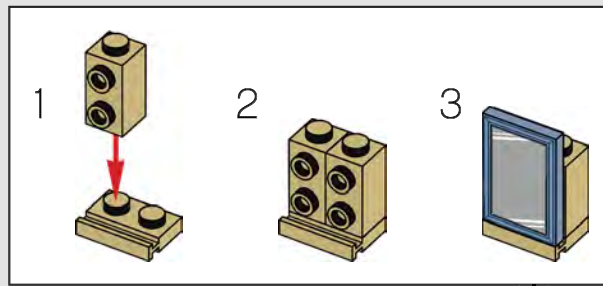
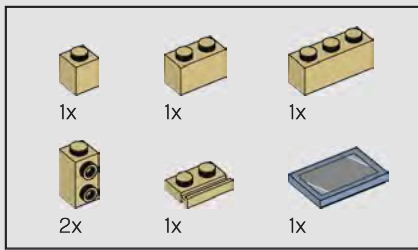

363

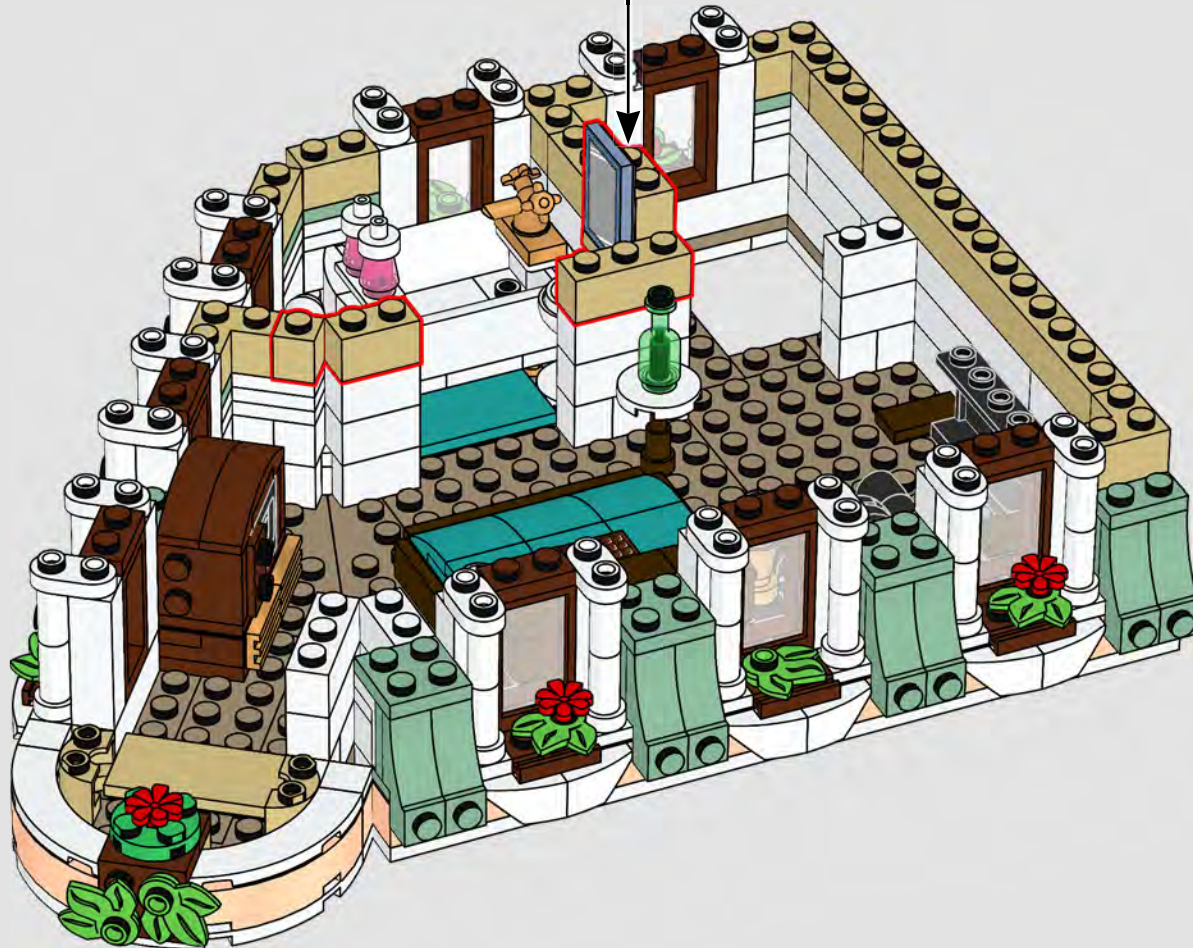

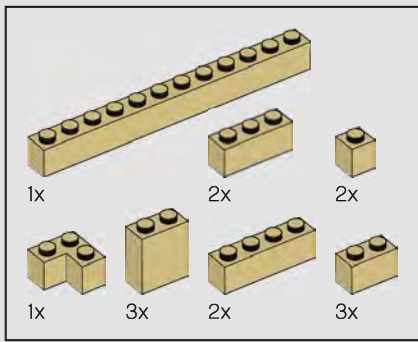

364



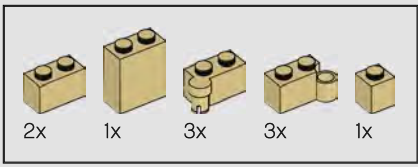

365

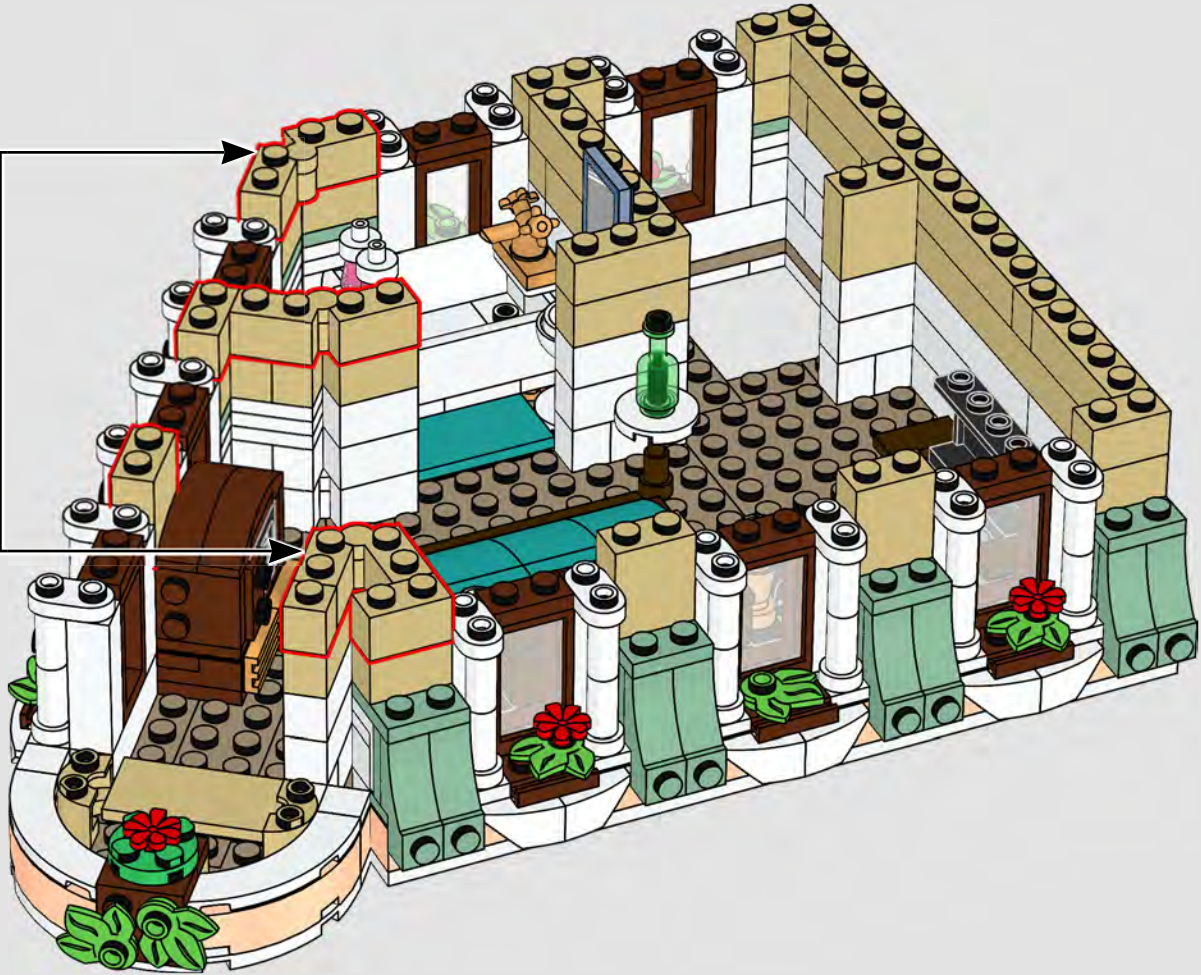
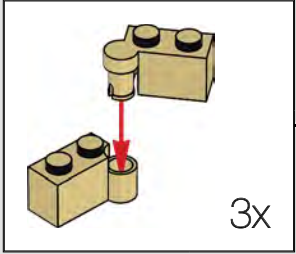



366

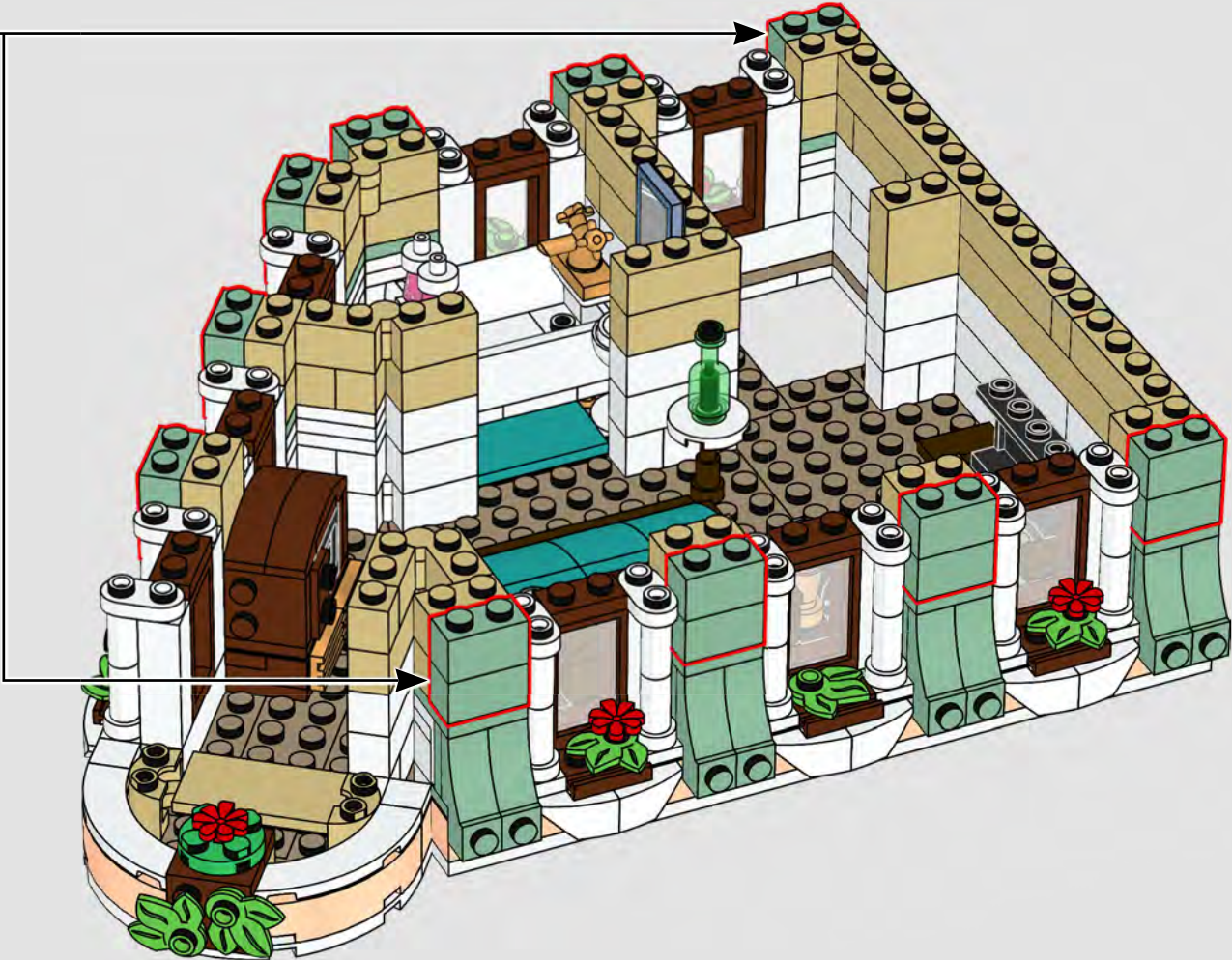
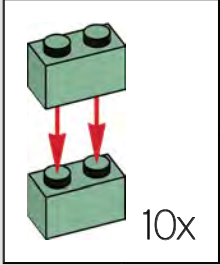

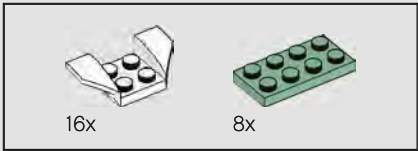

367

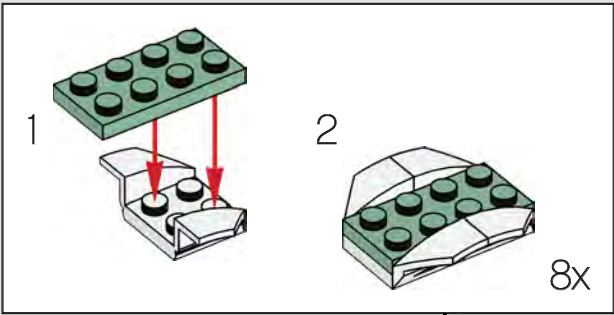

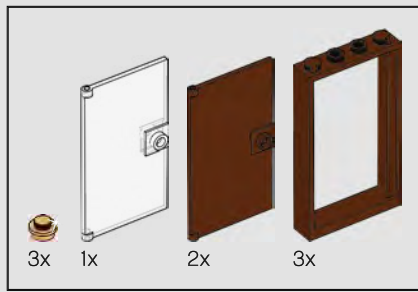

368

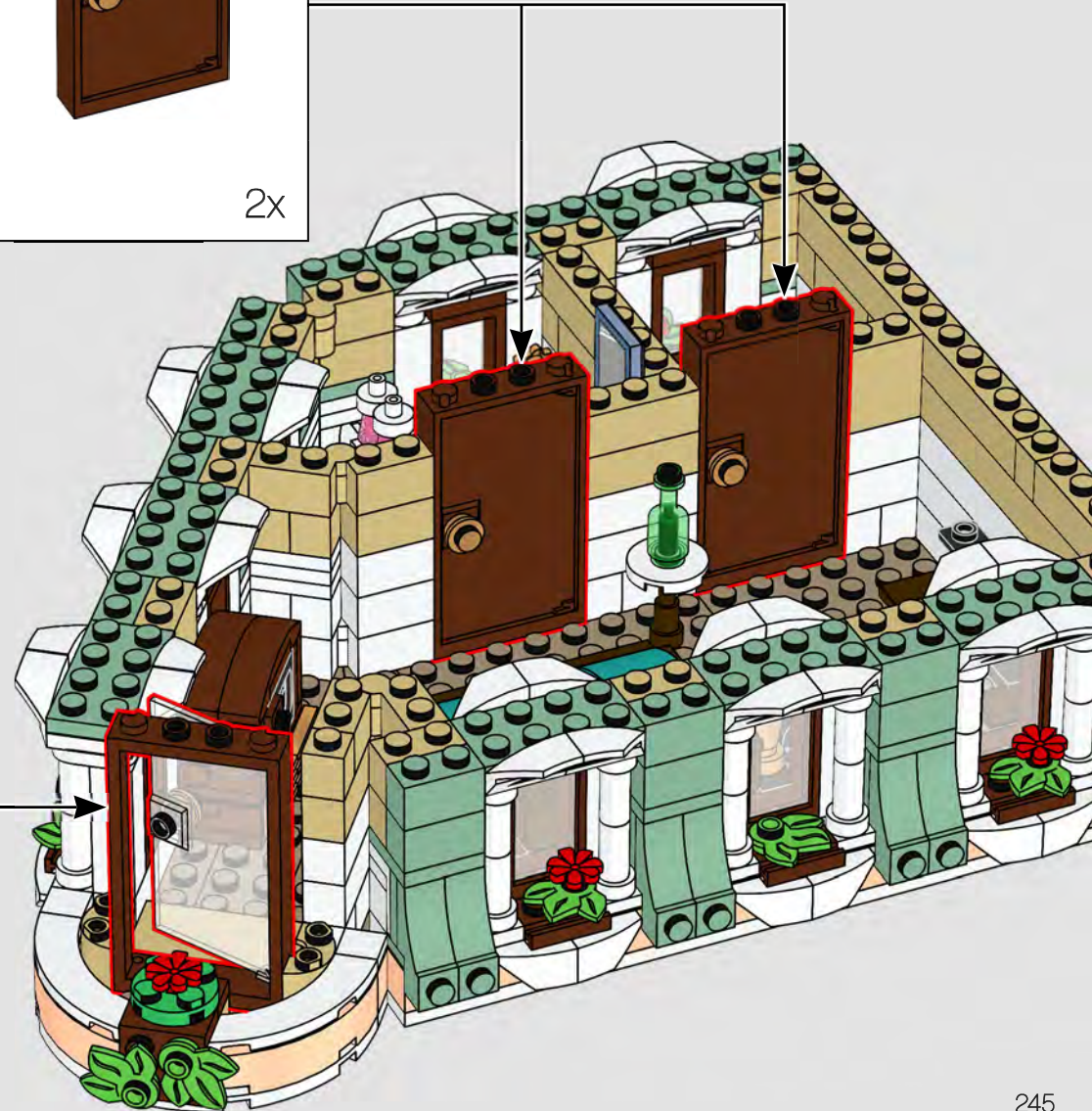
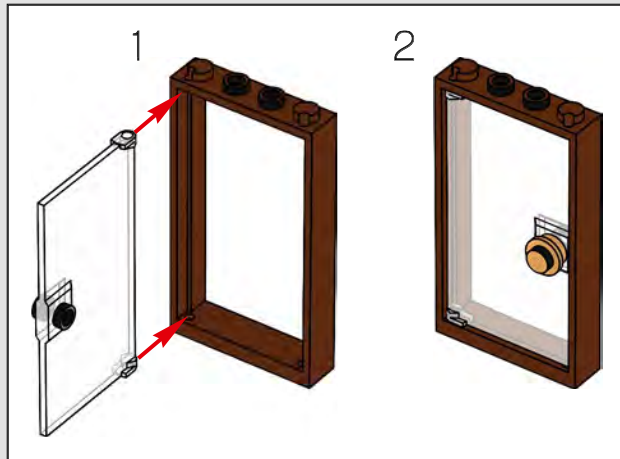
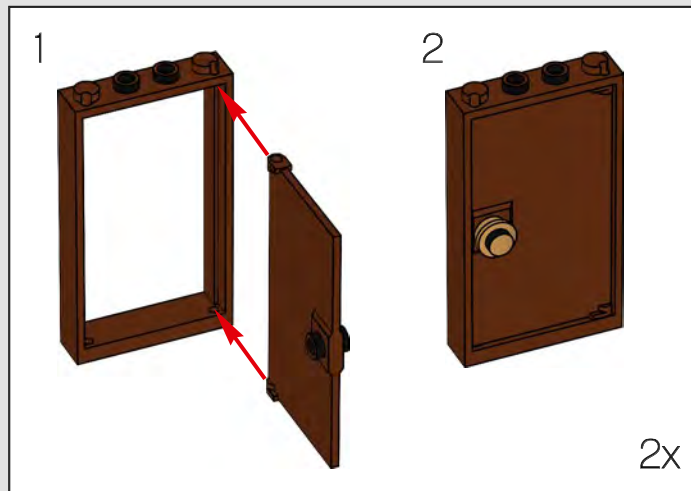

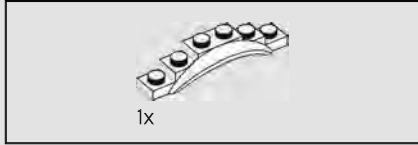
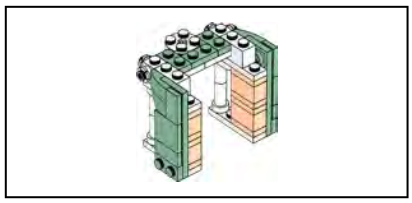

369

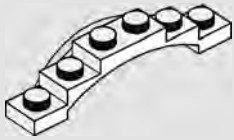

370

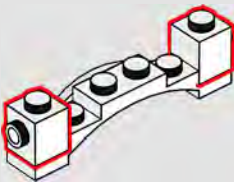

371

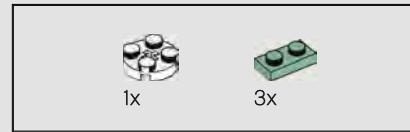
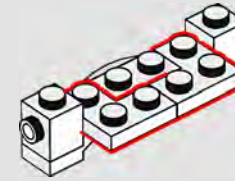

372

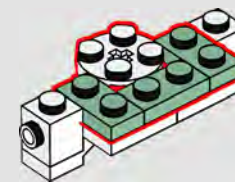



373

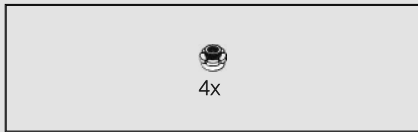
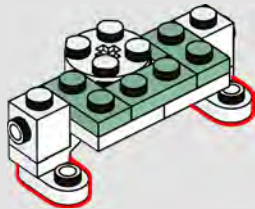

374

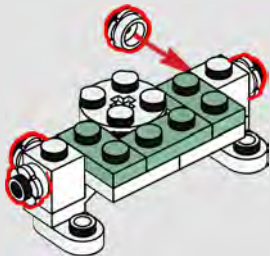

375

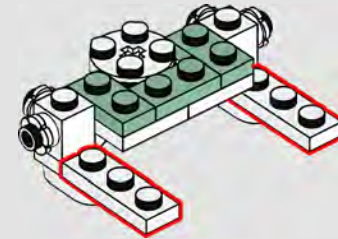

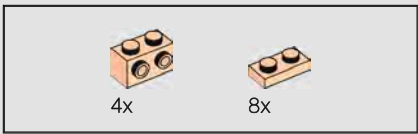

376

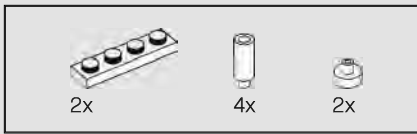
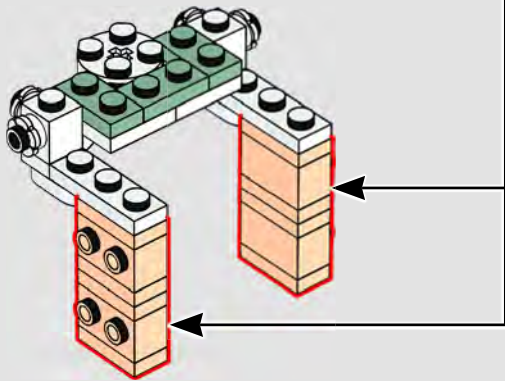
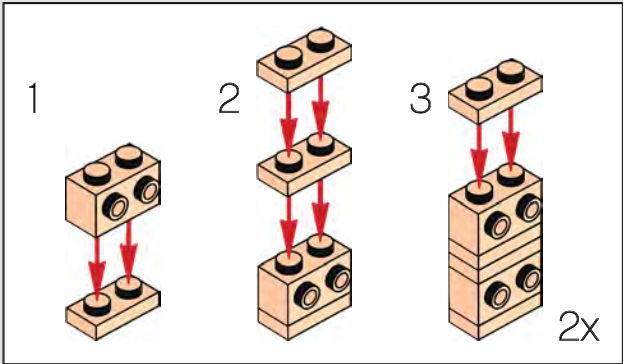

377

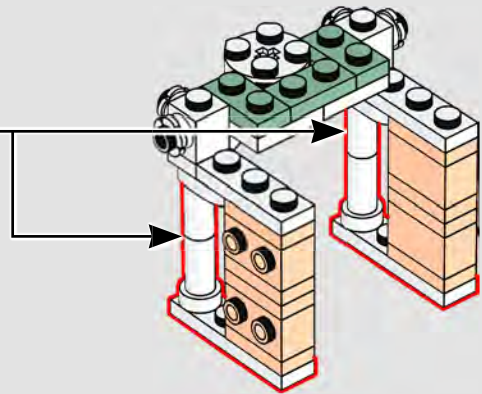
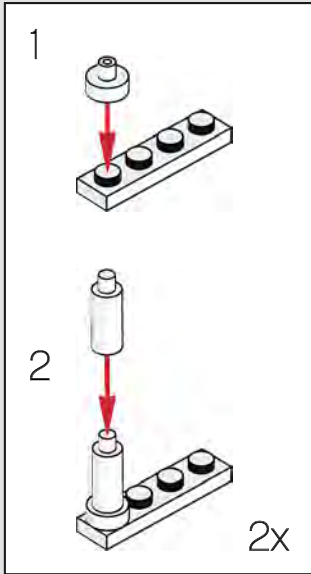



378

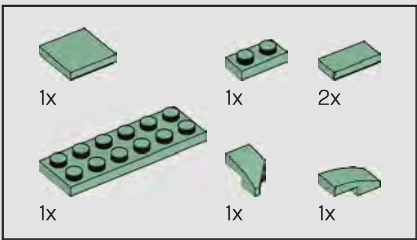
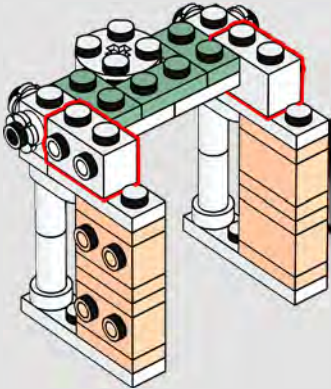

379

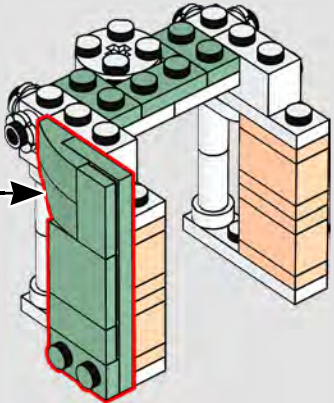
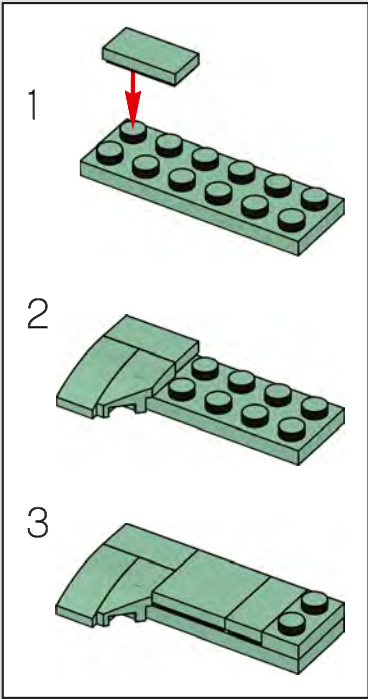

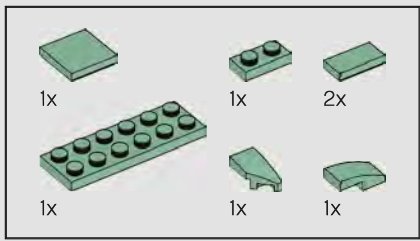

380

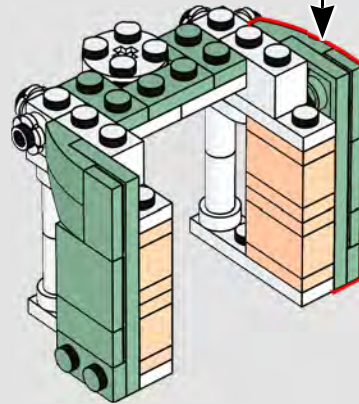
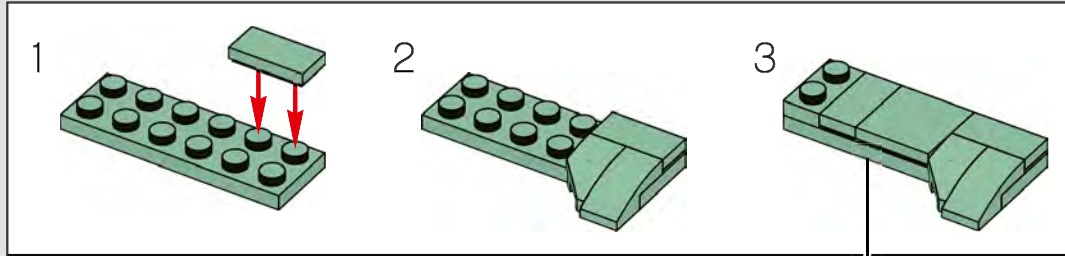

381



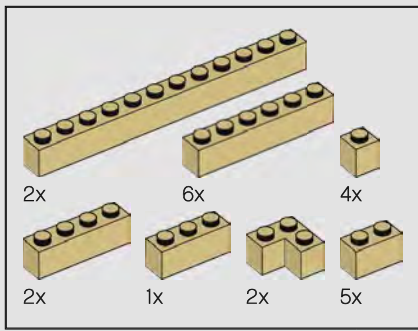

382





383



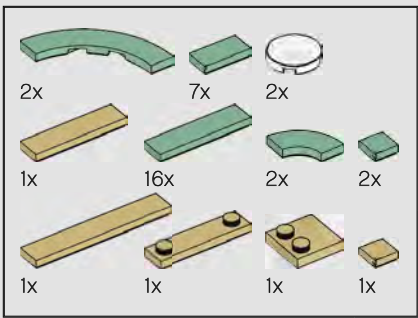

384



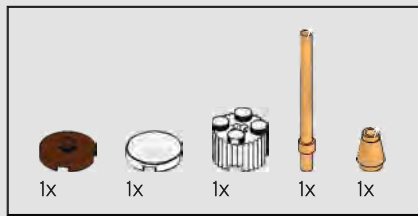

385

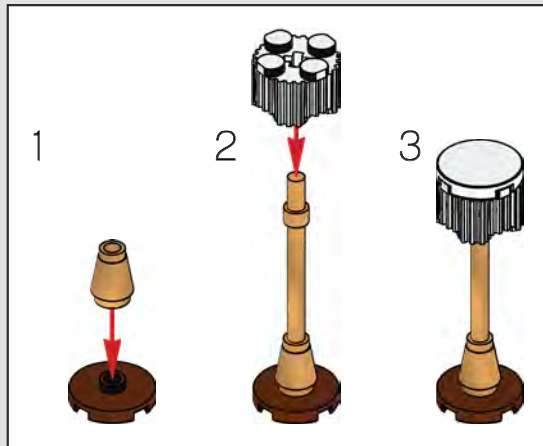

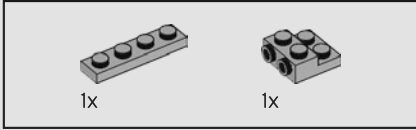

386

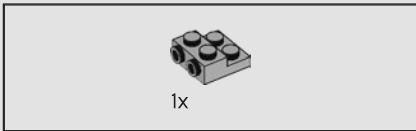
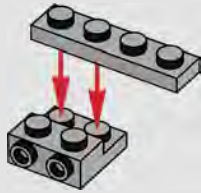

387



388

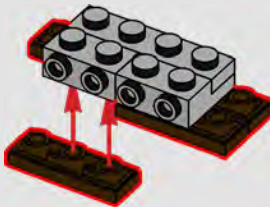

389

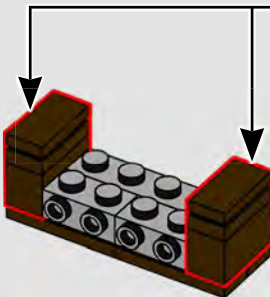
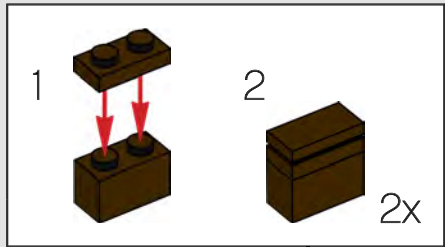

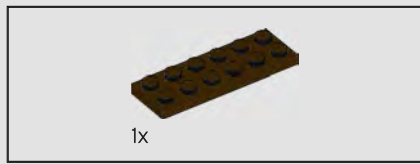

390

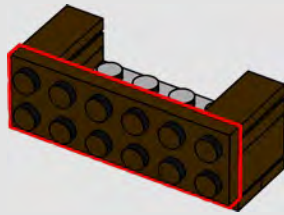

391

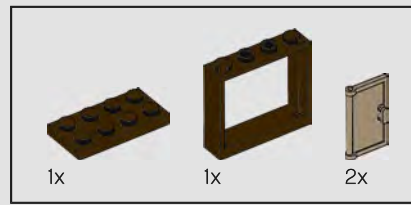
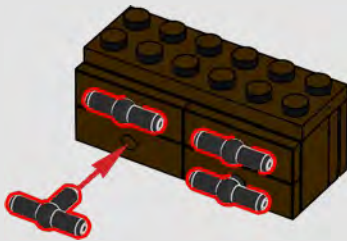

392

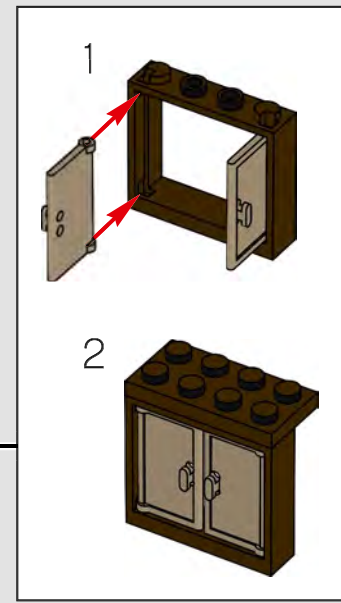
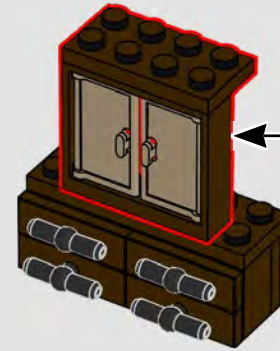

393

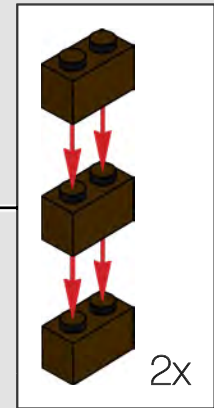
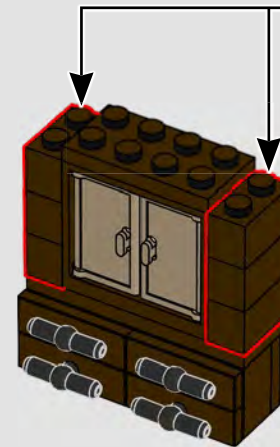

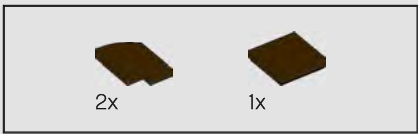

394

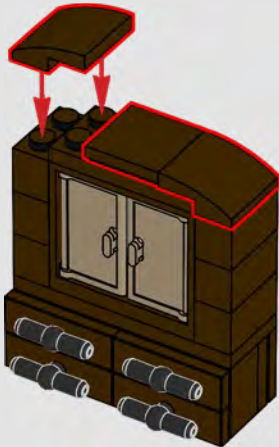

395



396

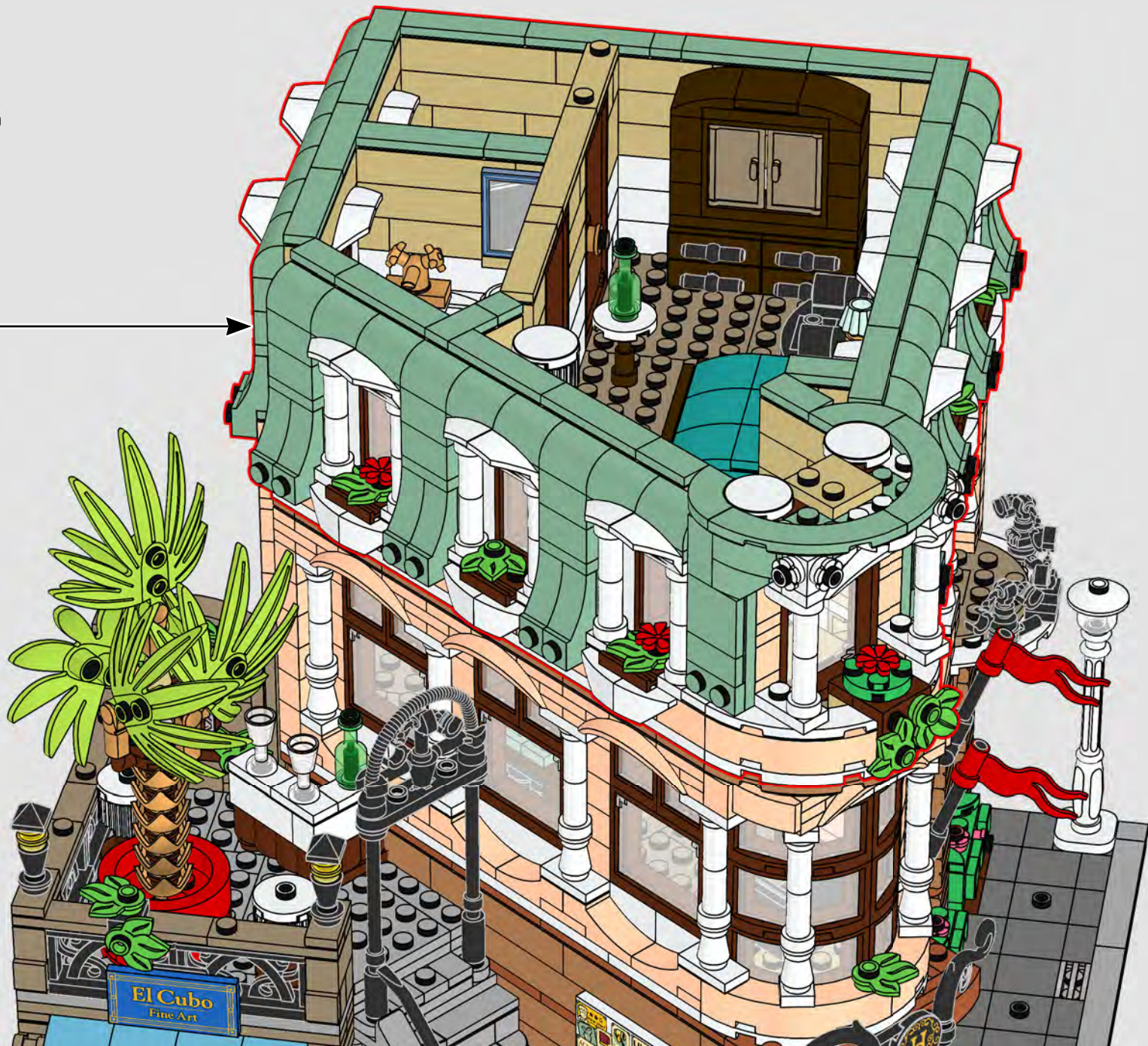

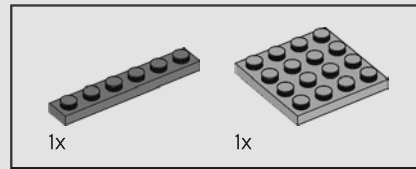
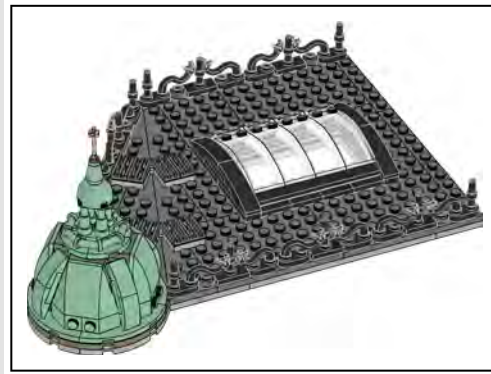
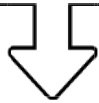

397

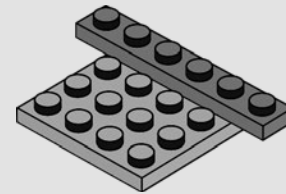

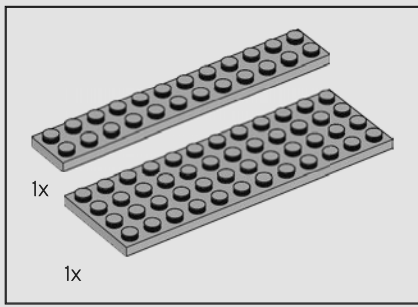

398

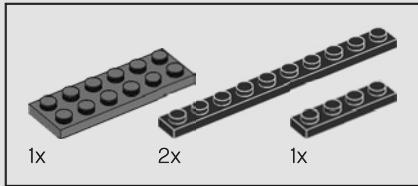
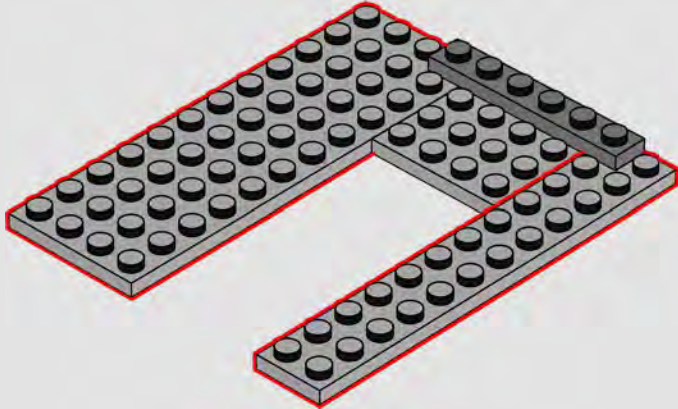

399

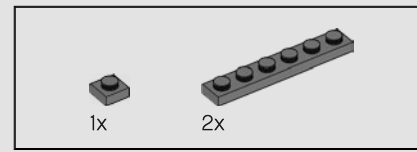
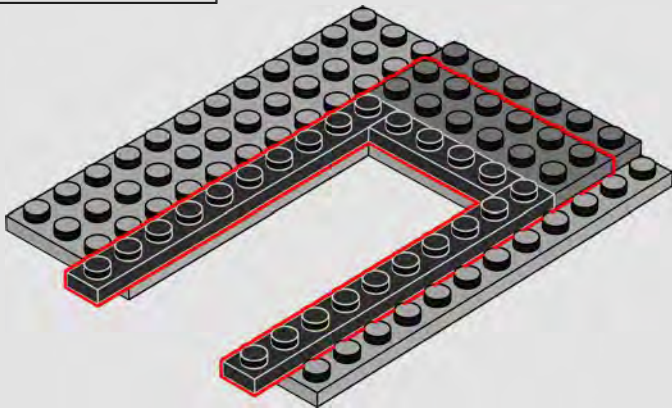

400

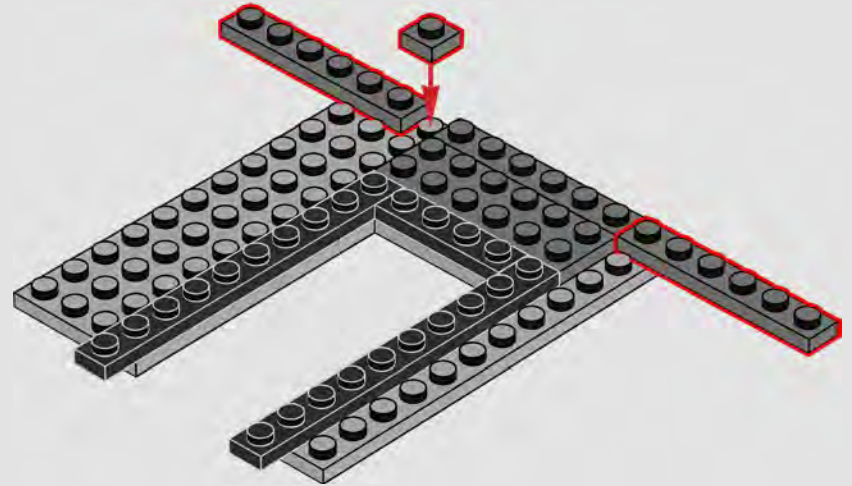

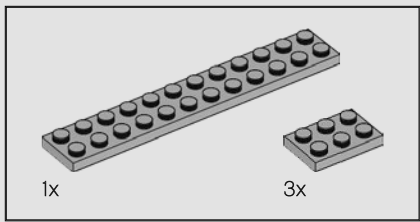

401

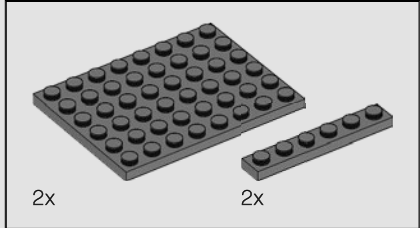
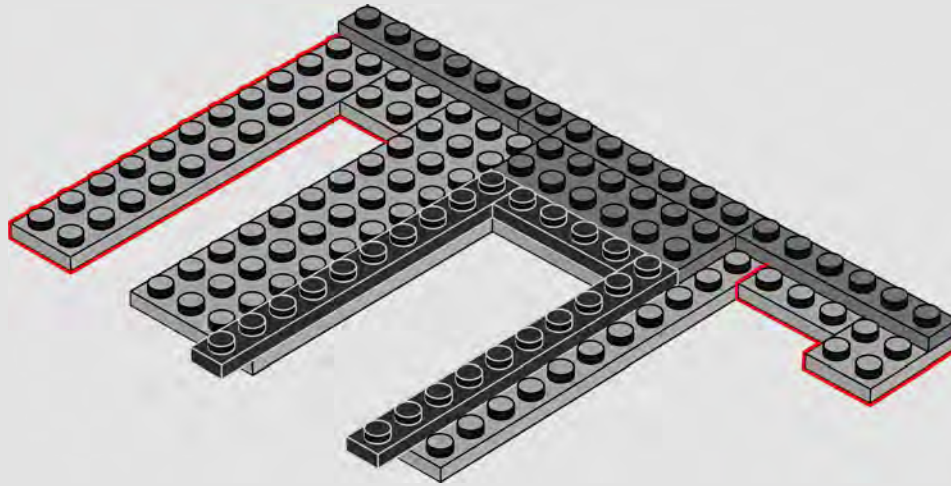

402

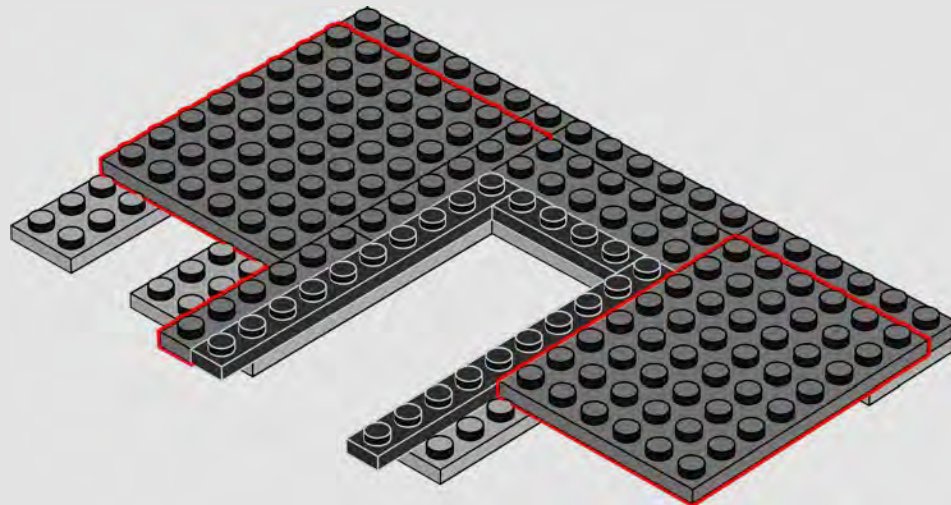

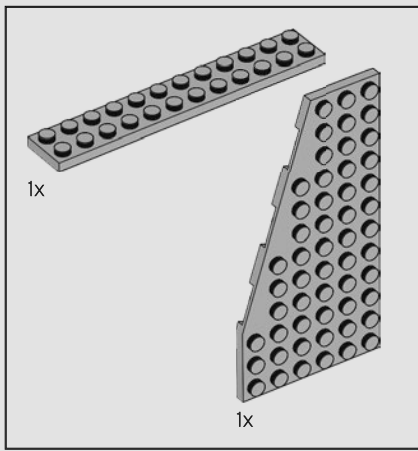

403

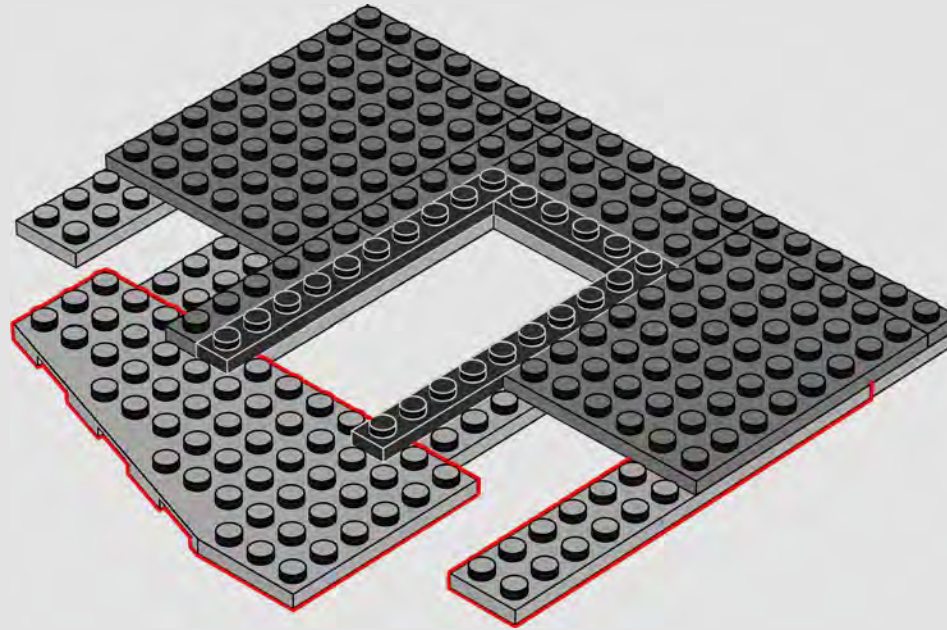

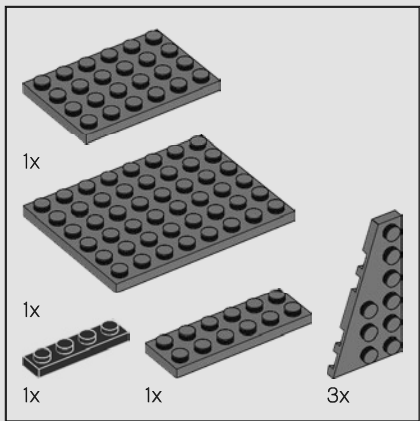

404

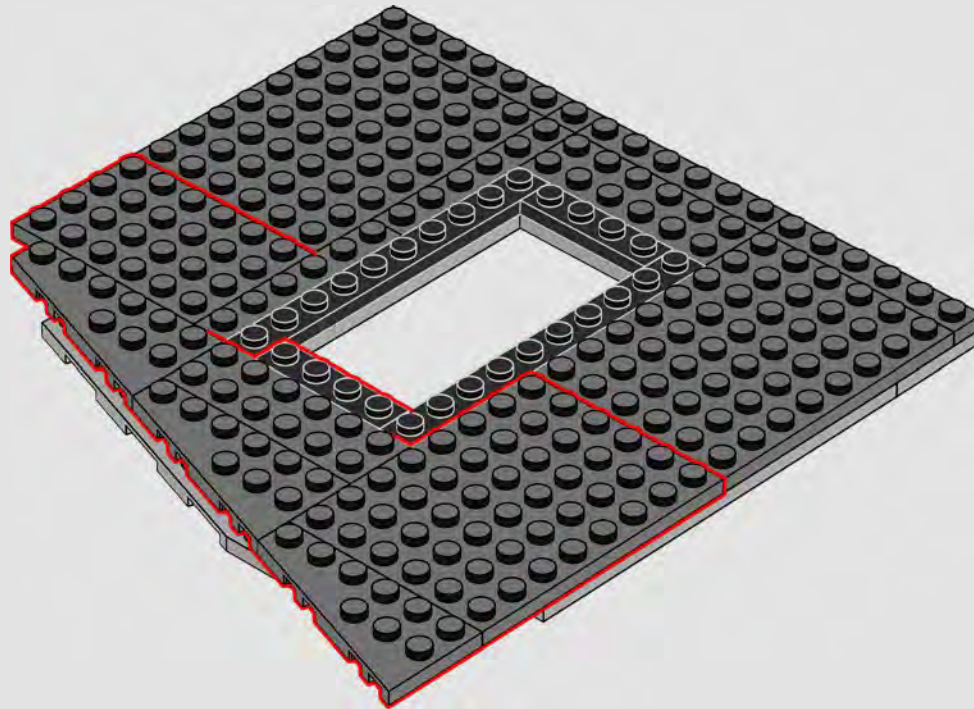

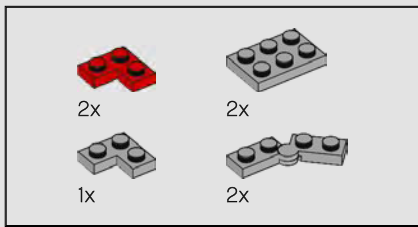

405

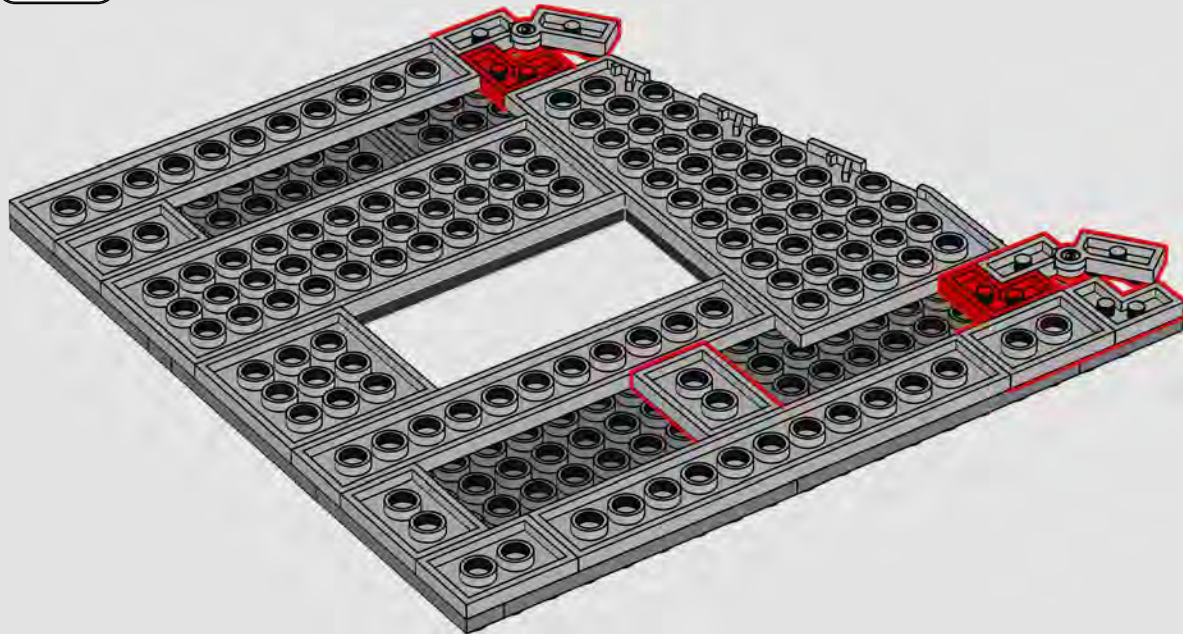



1x

406

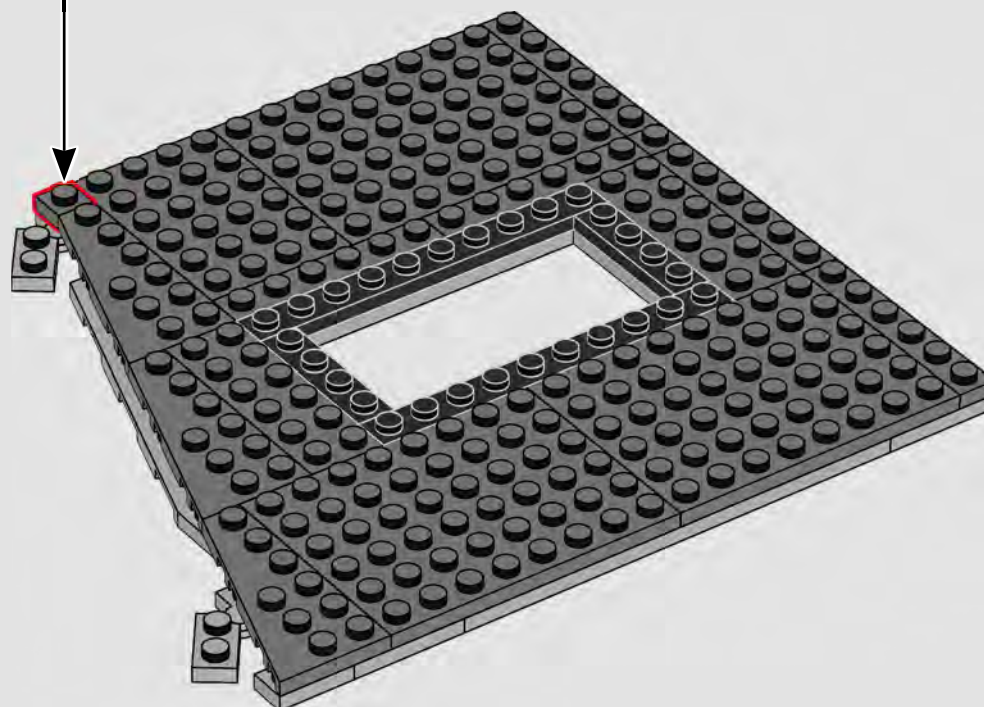
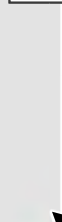
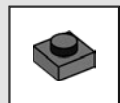

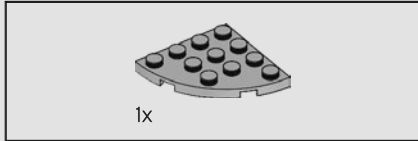
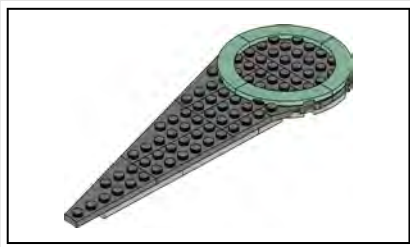

407

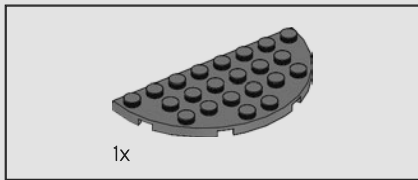
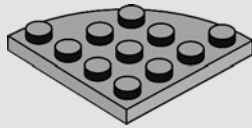

408

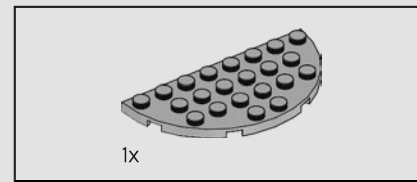
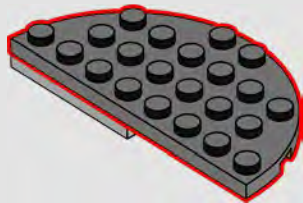

409

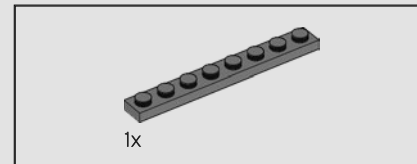
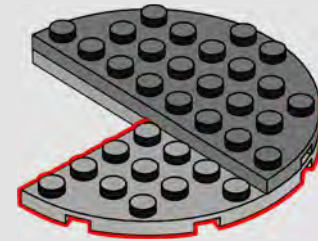

410

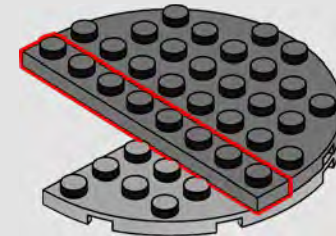

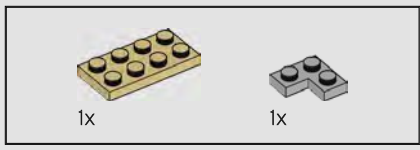

411

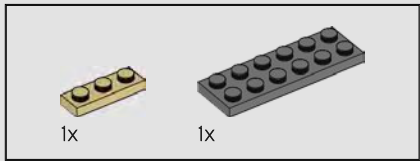
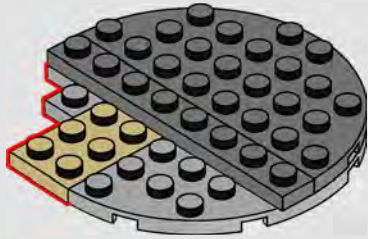

412

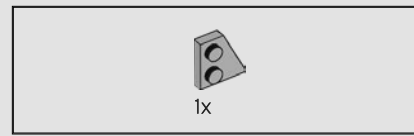
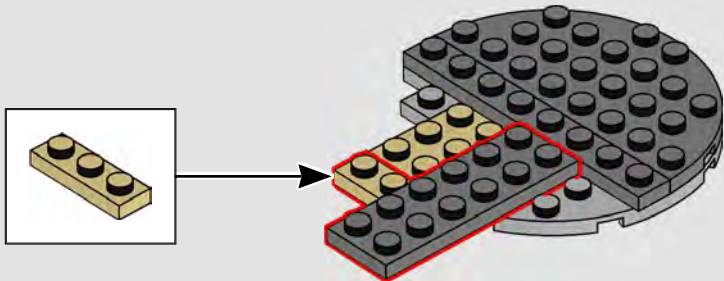

413

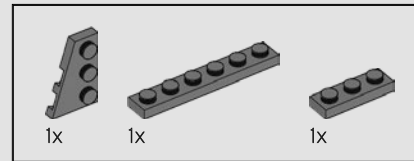
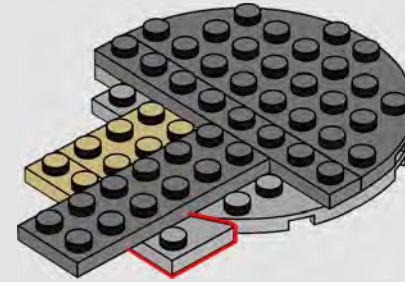

414

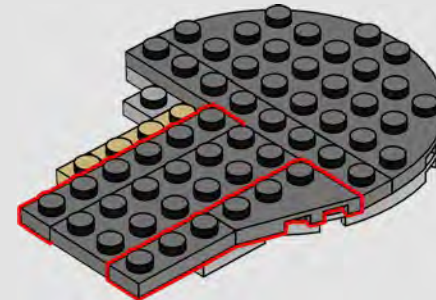

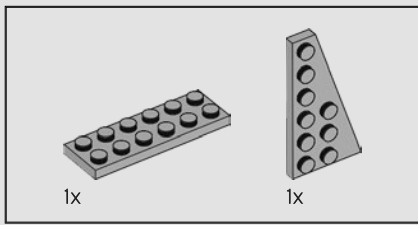

415

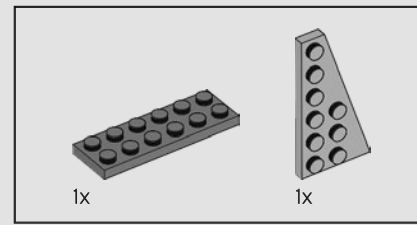
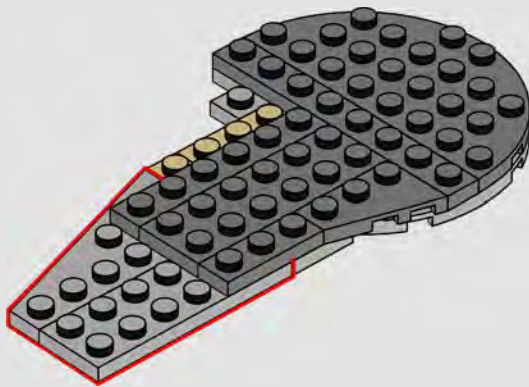

416

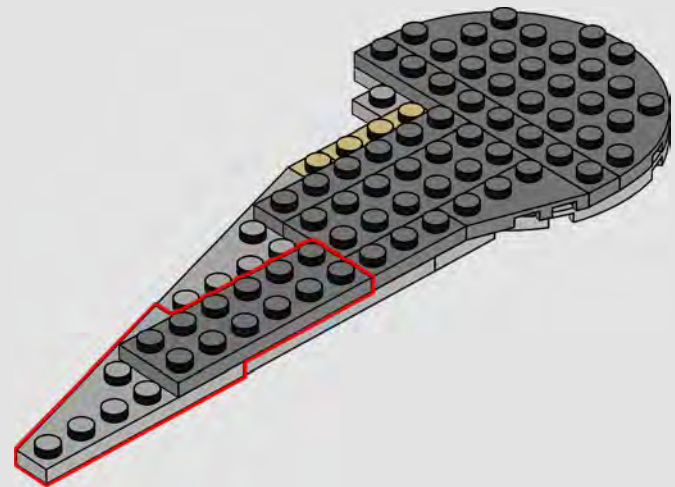

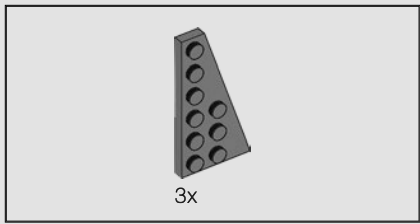

417

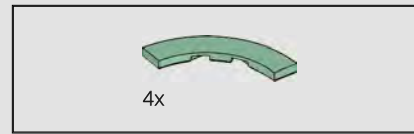
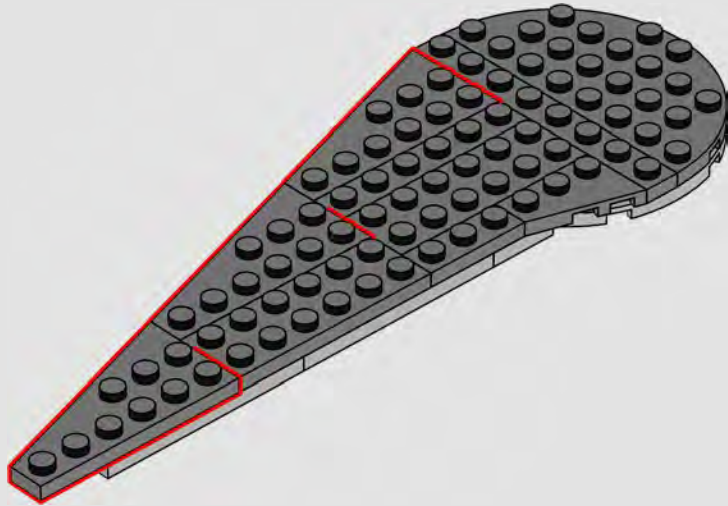

418

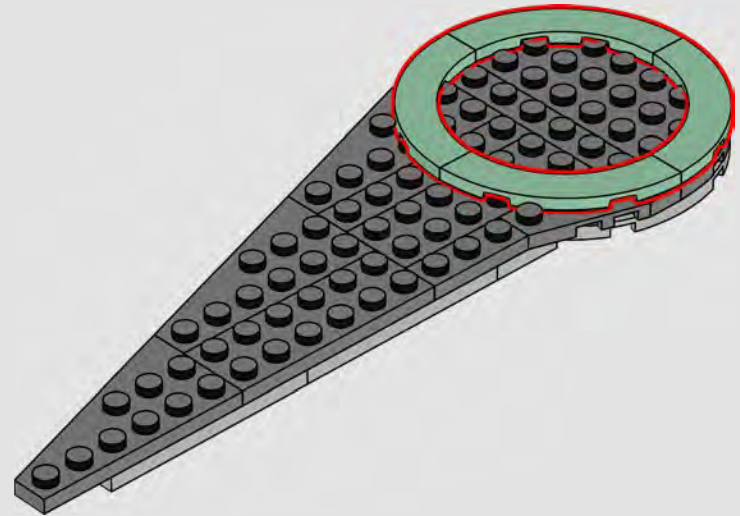

419

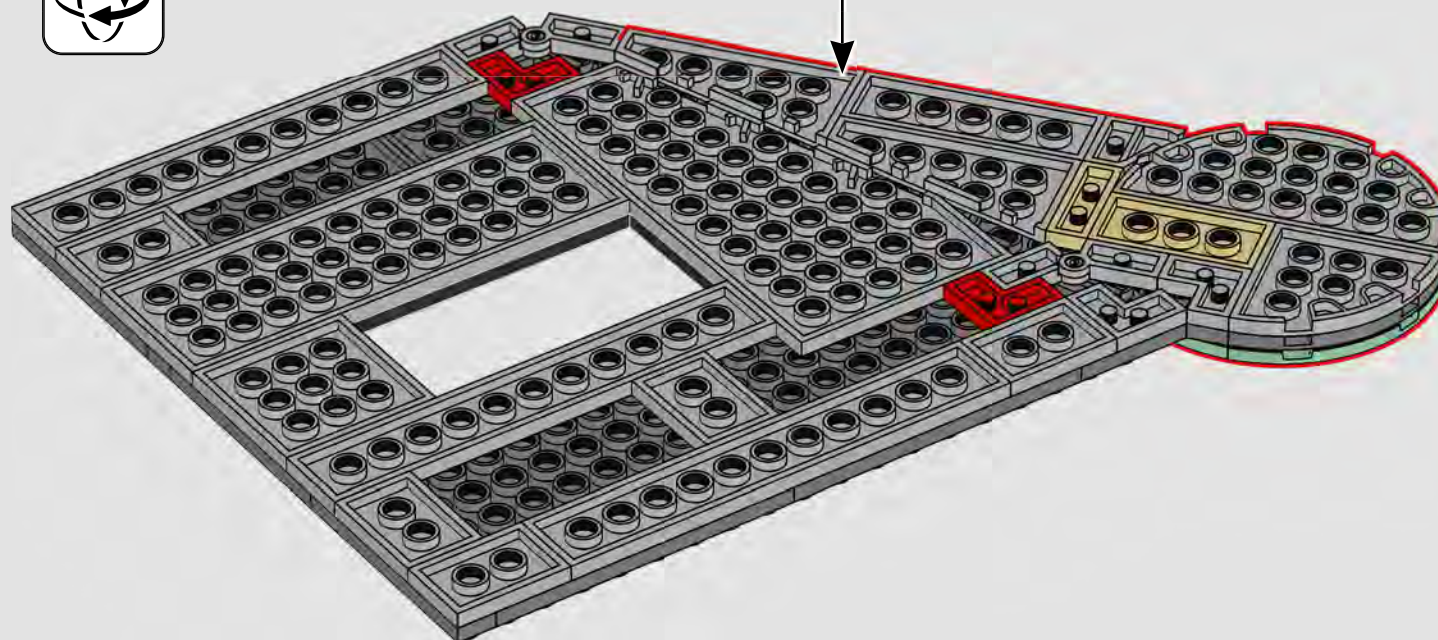



420

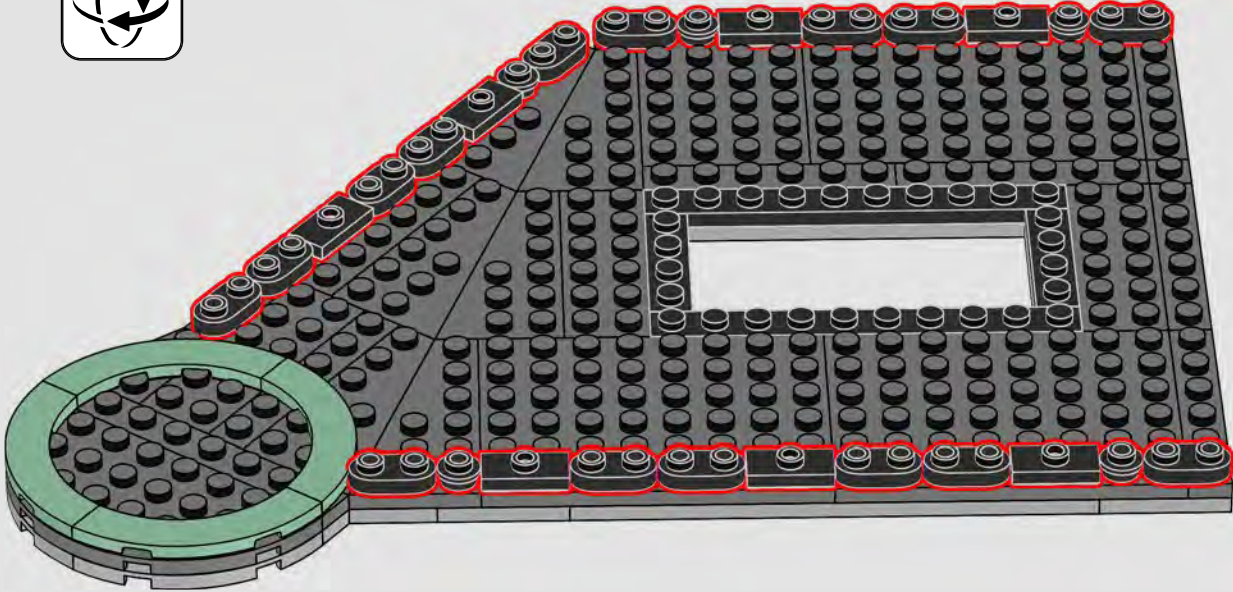

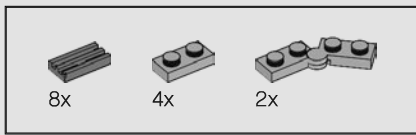

421

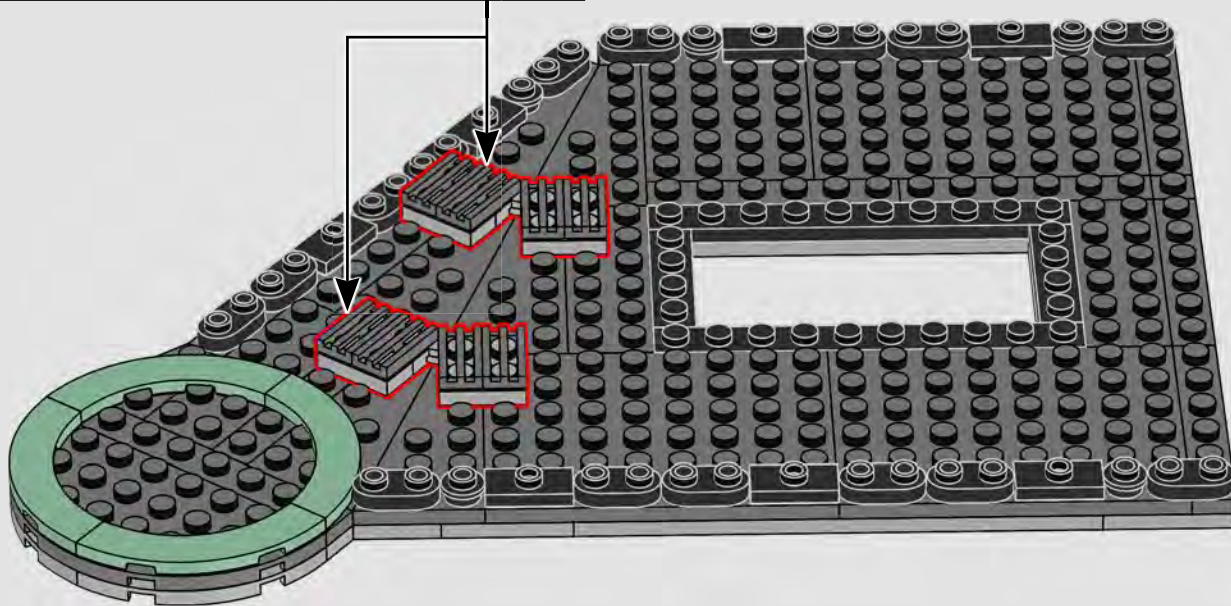
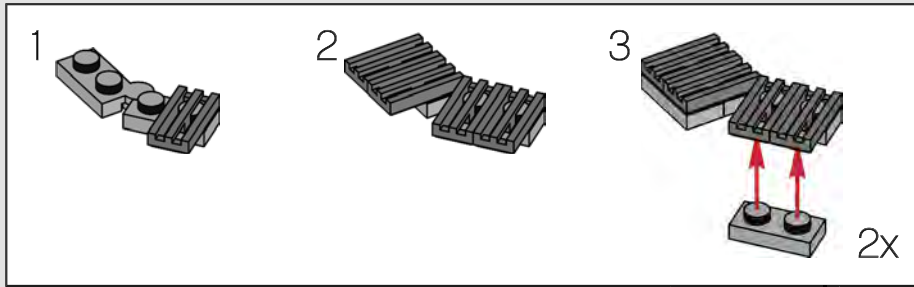



12x

422

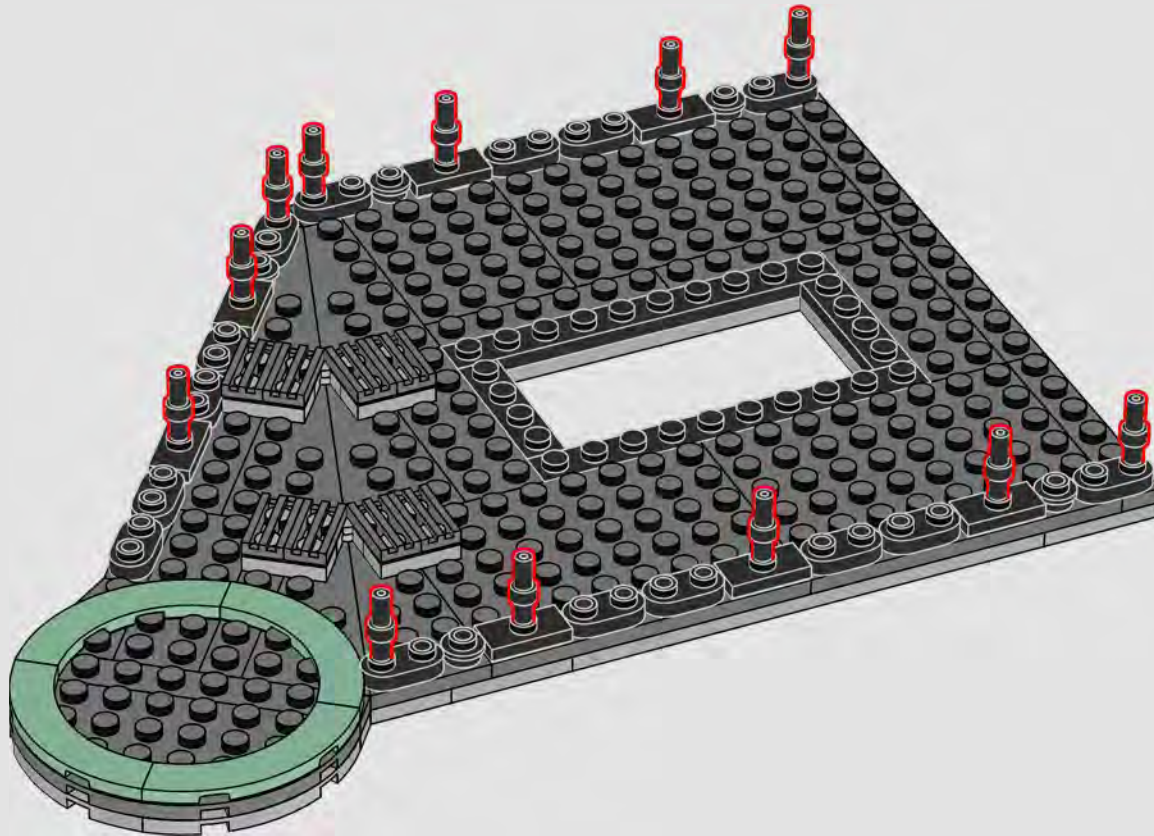



423



The elements used to make the curves of this wrought-iron detailing first appeared in NINJAGO® sets as a Snake Head.

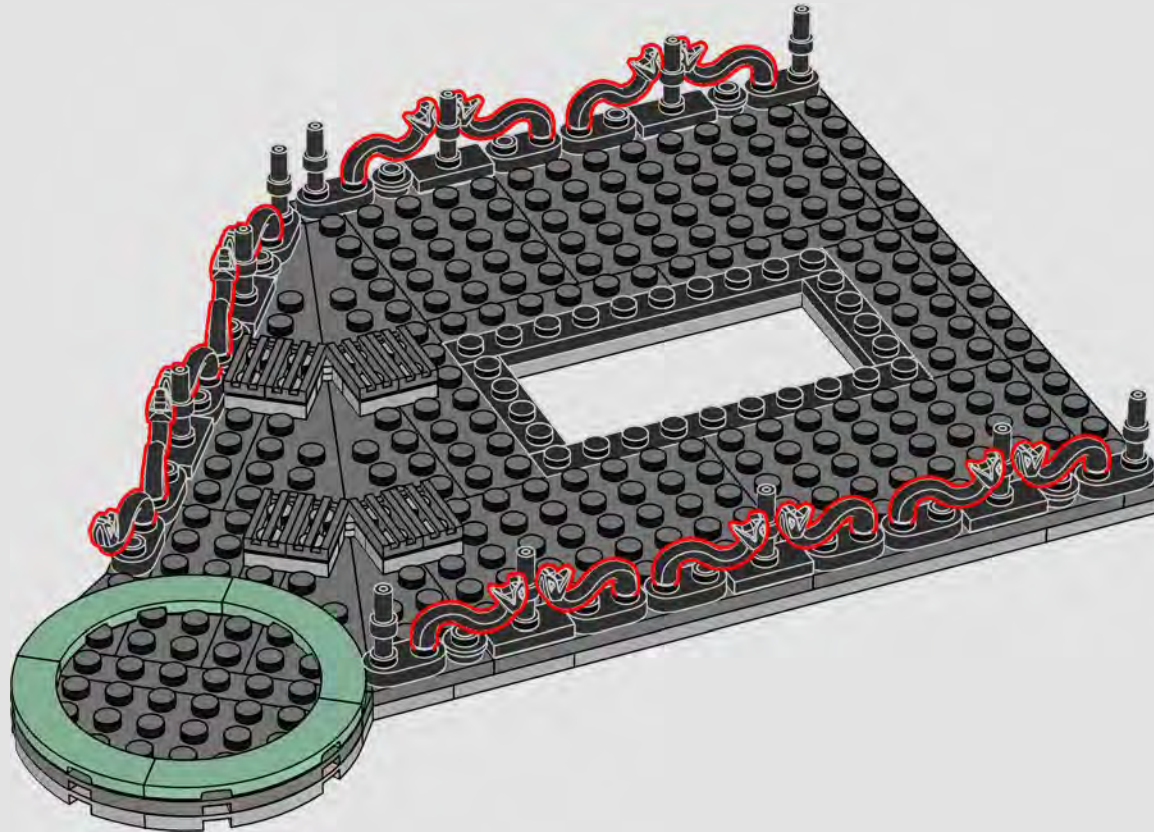

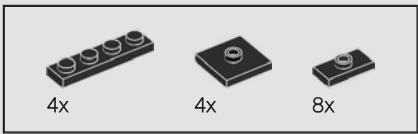

424

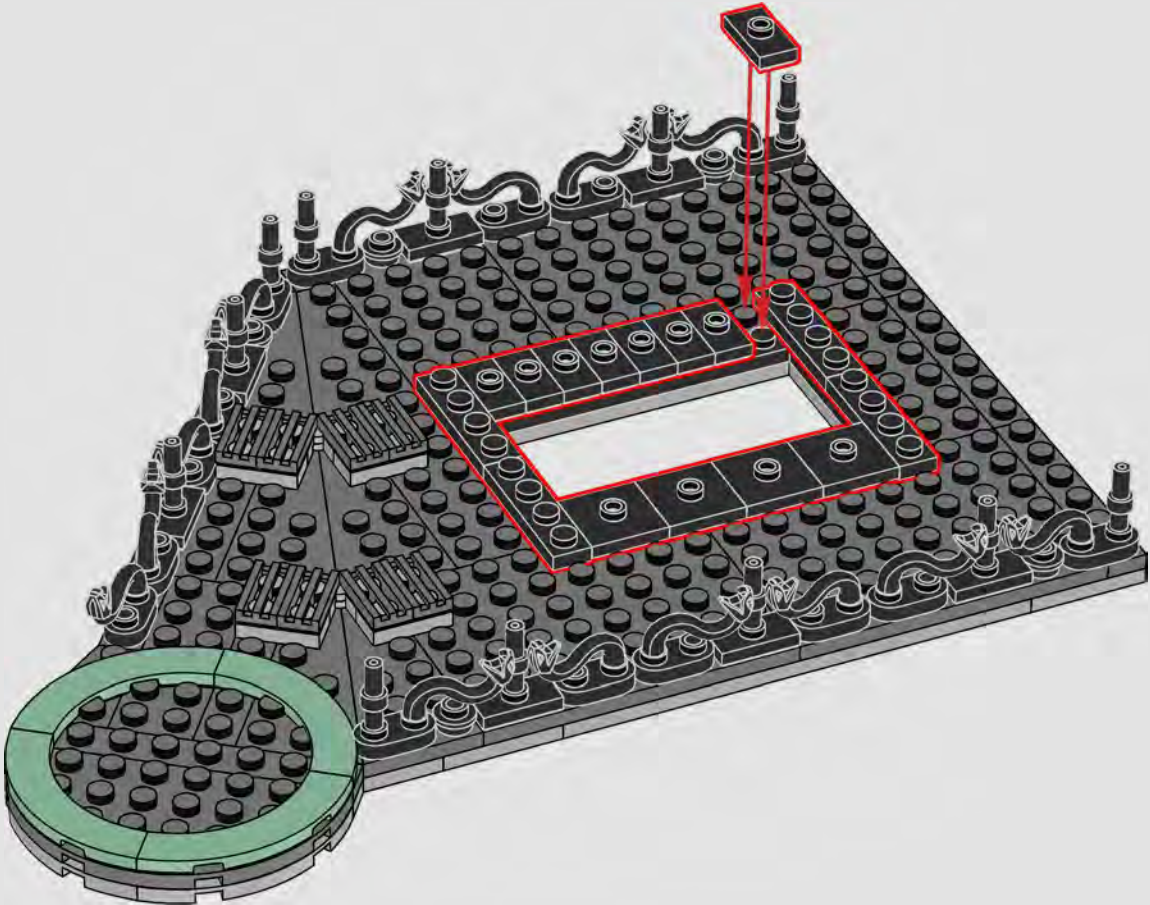

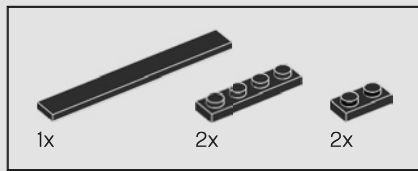

425

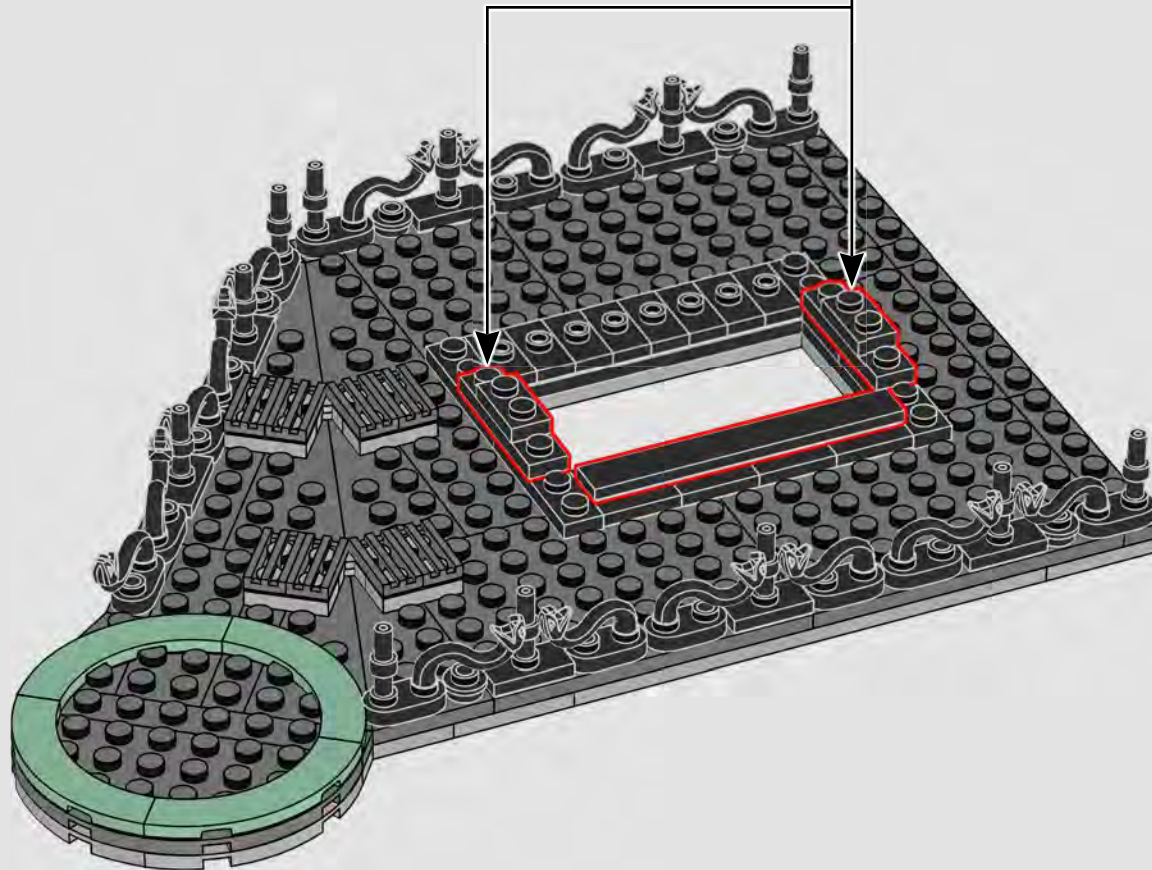
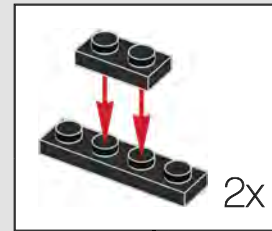



426

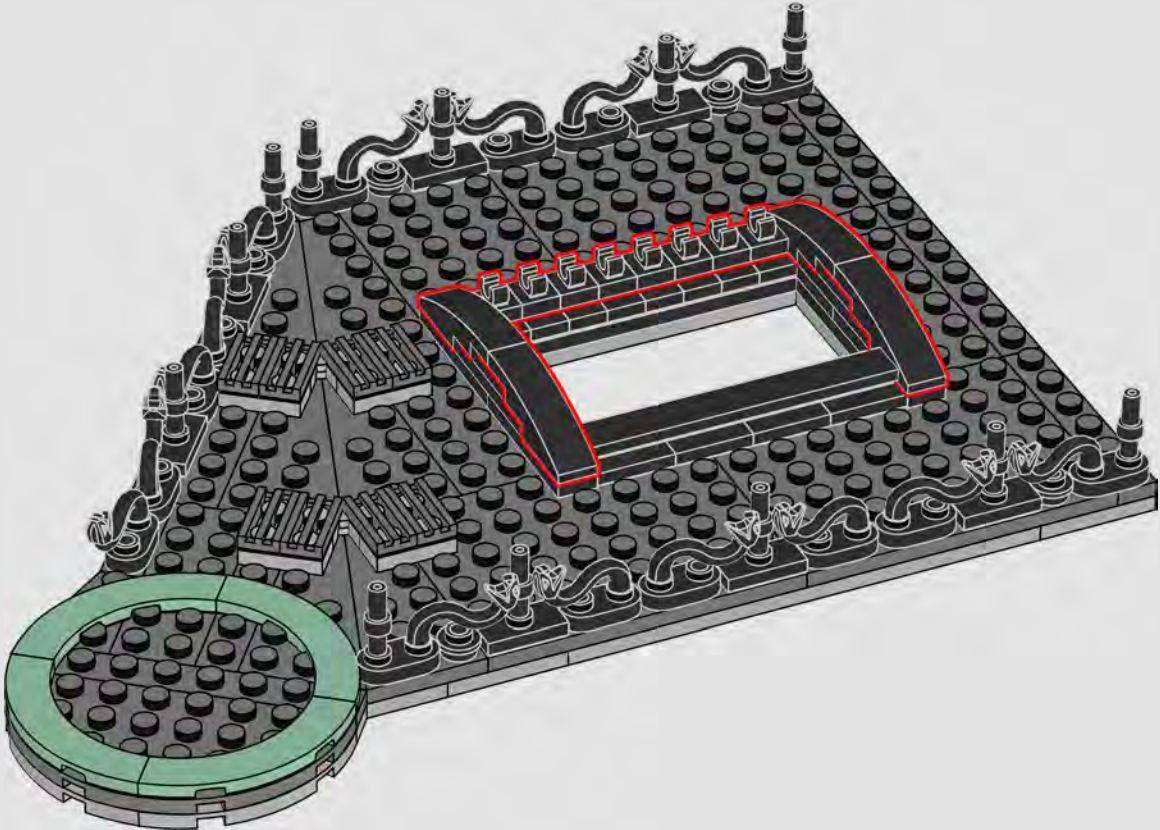

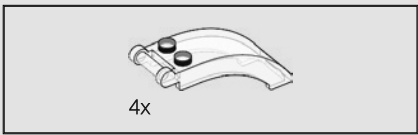

427

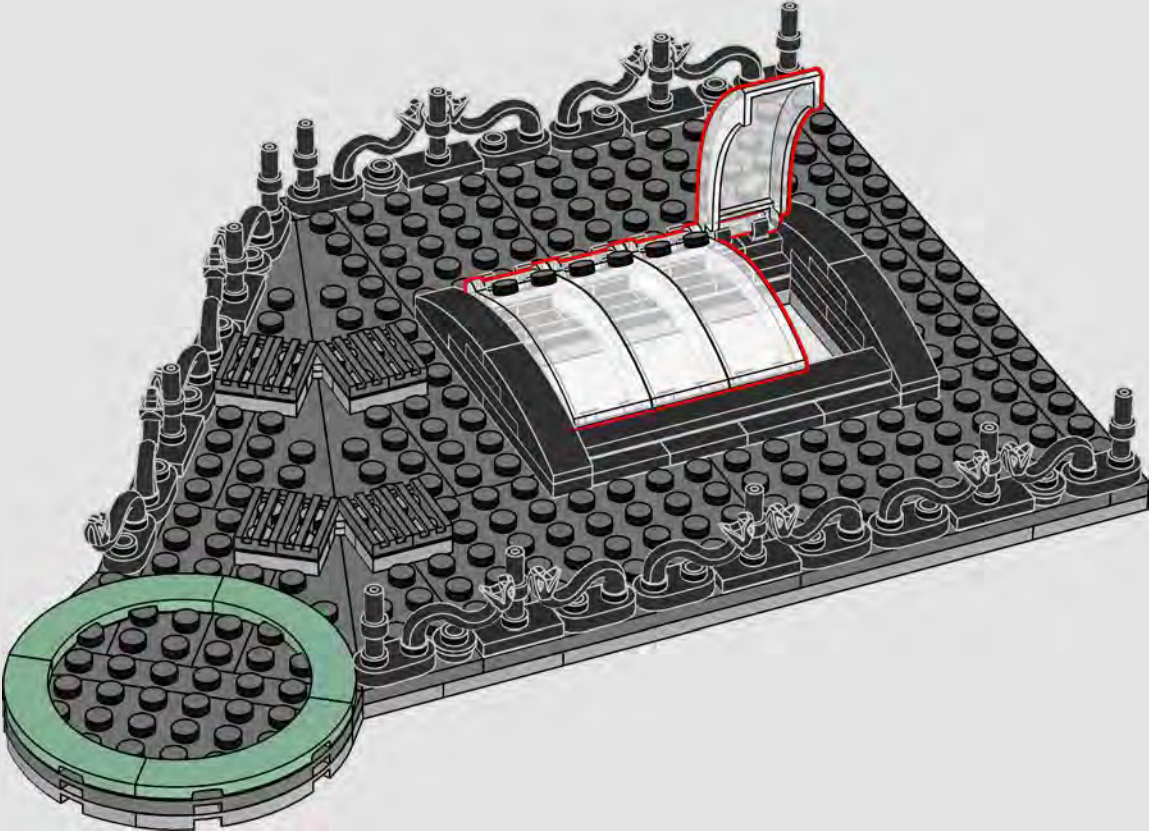

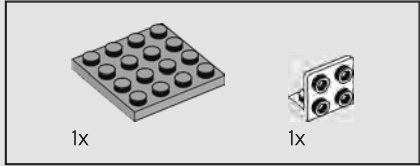

428

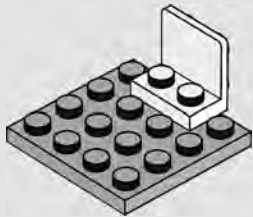

429

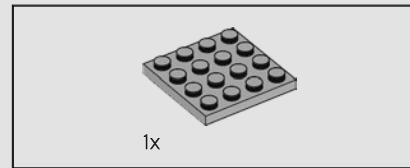
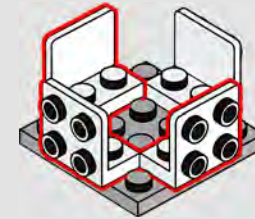

430

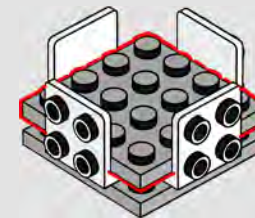

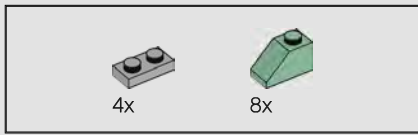

431

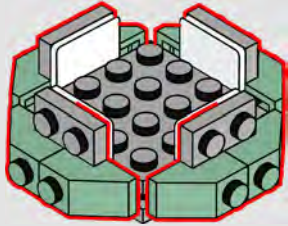

432

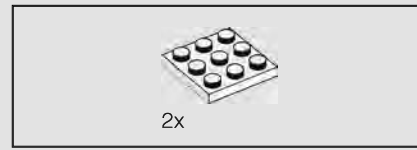
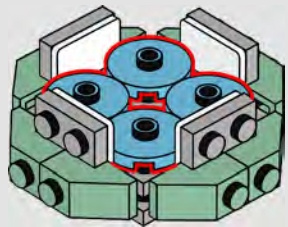

433

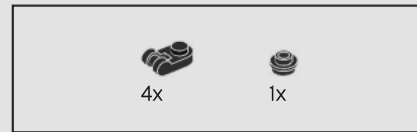
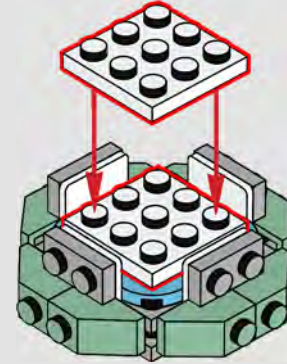

434

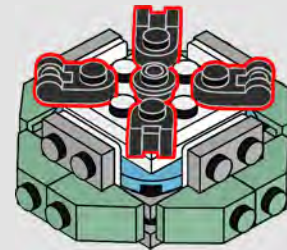

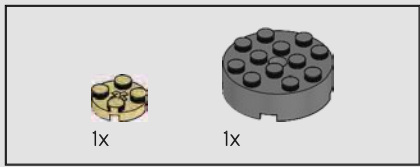

435

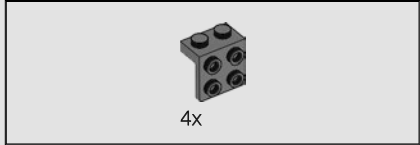
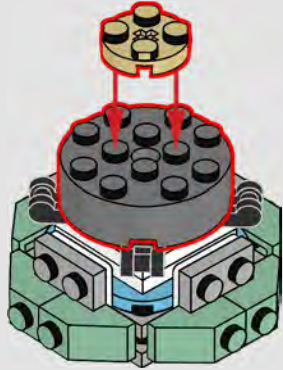

436

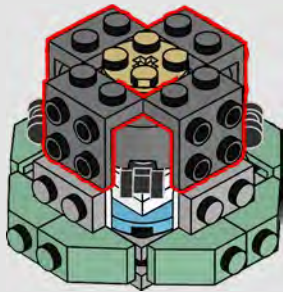

437

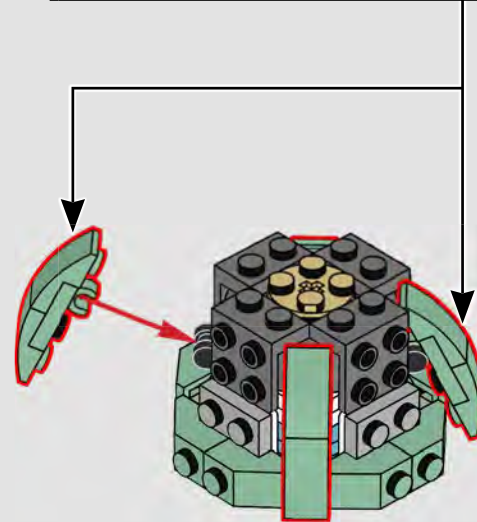
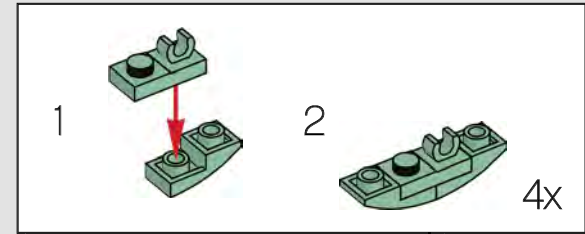



438

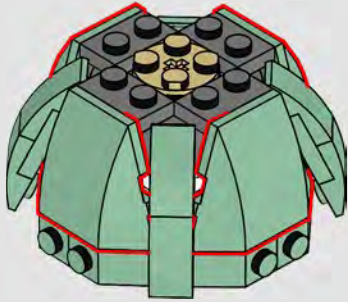

439

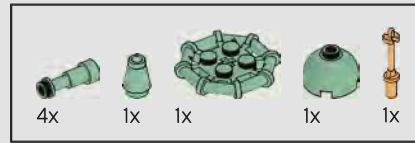
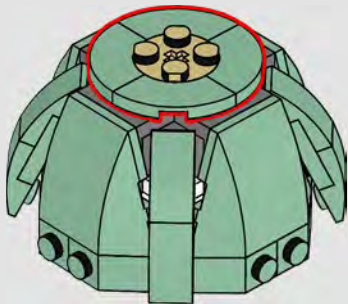

440

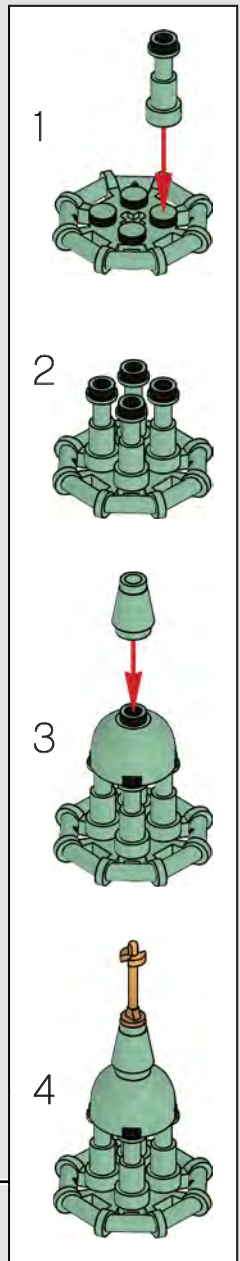
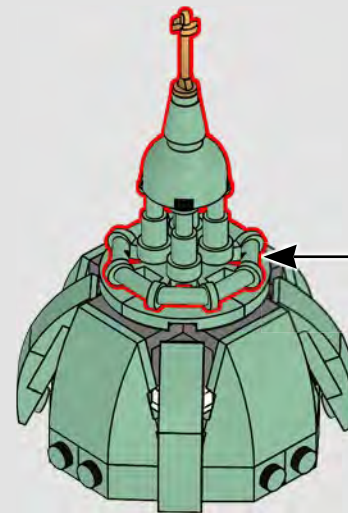

441

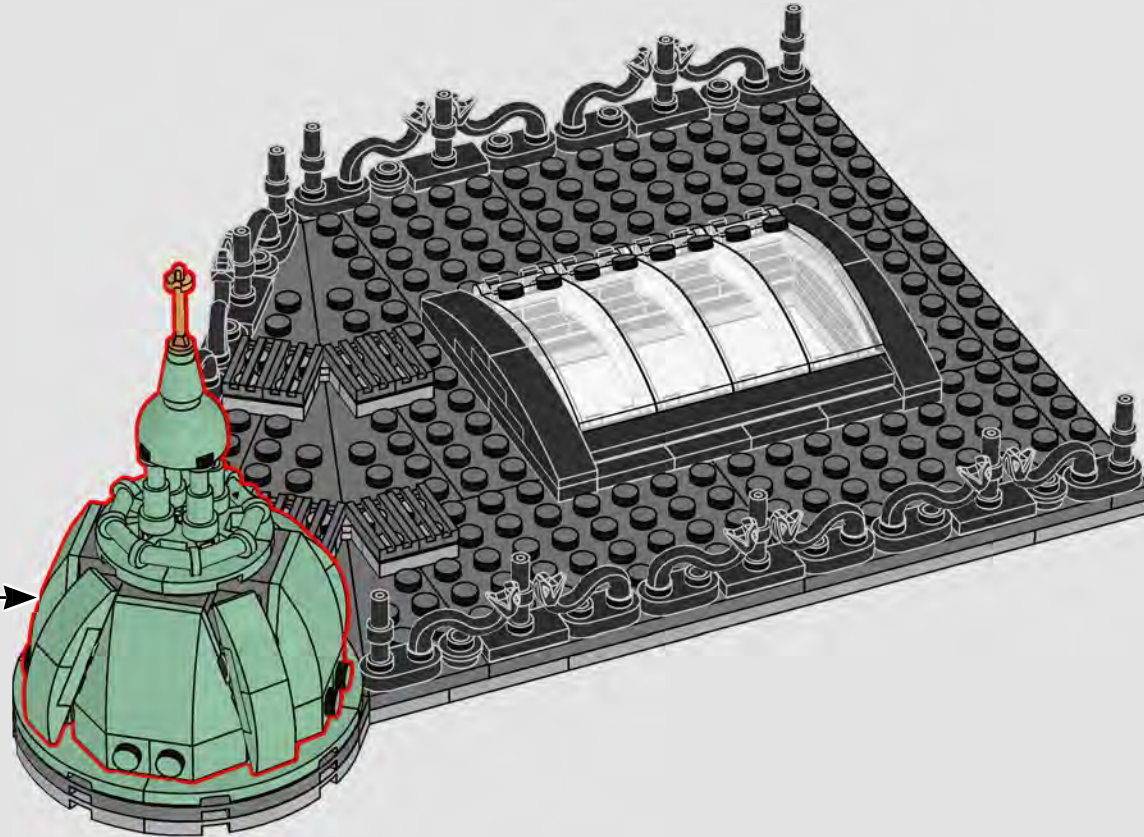

442





1

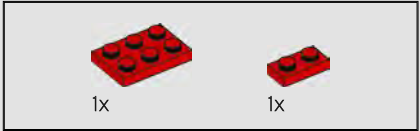

2

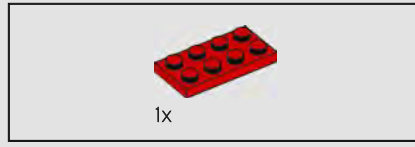
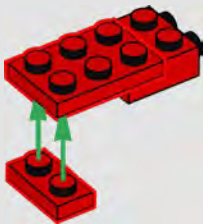

3

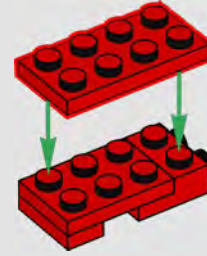

4





5

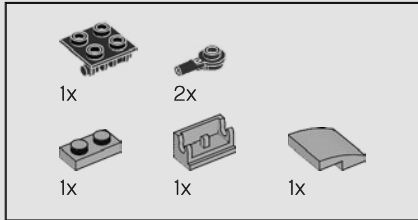
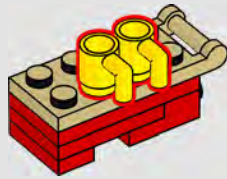

6

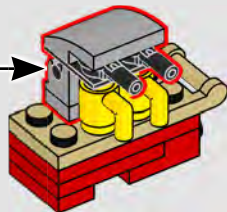
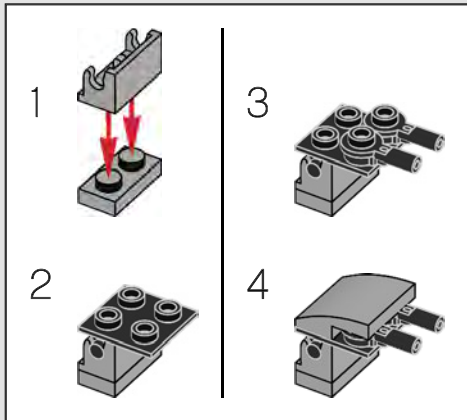

7

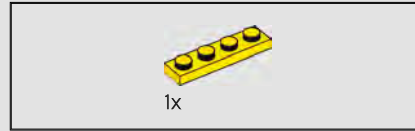
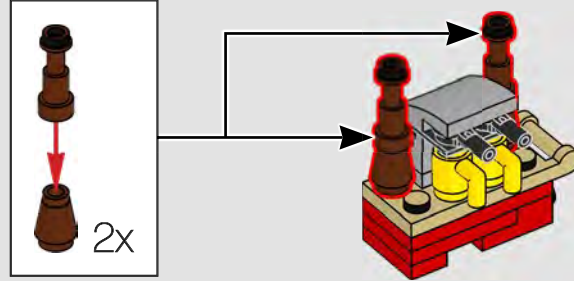

8

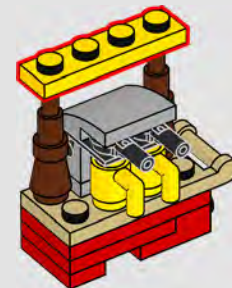



9

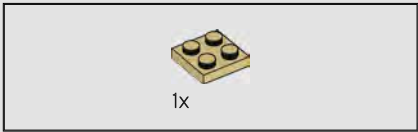
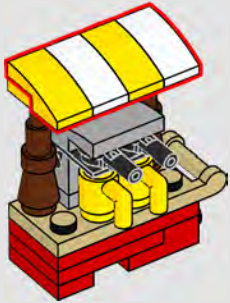

10

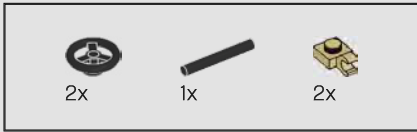
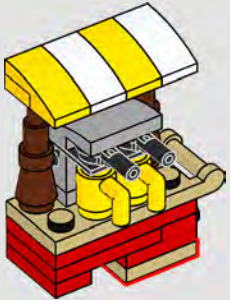

11

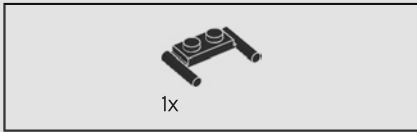
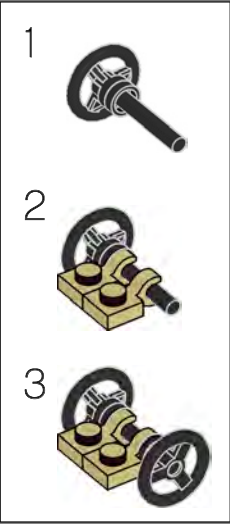
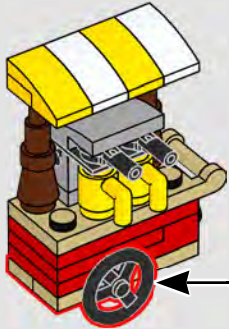

12

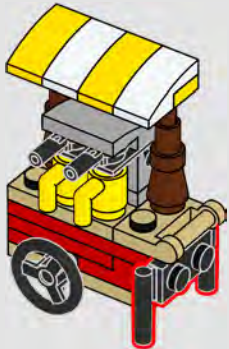

This coffee cart is the mobile extension of the 10182 Café Corner set, the very first Modular Building. Its awning and yellow coffee cups match the ones from the original building.

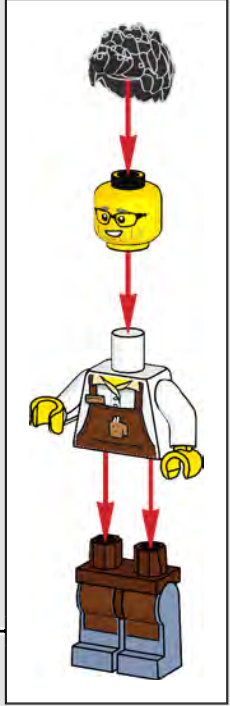





FEEDBACK AND WIN



FEEDBACK AND WIN

Your feedback will help shape the future development of this product series.

Please visit:

FEEDBACK UND GEWINNEN

Dein Feedback trägt zur Weiterentwicklung dieser Produktreihe bei.

Geh auf:

COMMENTEZ ET GAGNEZ

Vos commentaires nous aideront à concevoir les futurs produits de cette gamme.

Rendez-vous sur :

COMENTA Y GANA

Tu opinión nos ayudará a dar forma al desarrollo de esta serie de productos en el futuro.

Visita:

反馈有奖

您的反馈将有助于我们在今后改进本系列产品。

请访问：

[LEGO.com/productfeedback](https://www.lego.com/productfeedback)

By completing, you will automatically enter a drawing to win a LEGO® set.

Terms & Conditions apply.

Durch Ausfüllen nimmst du automatisch an der Verlosung eines LEGO® Preises teil.

Es gelten die Teilnahmebedingungen.

En envoyant vos commentaires, vous serez automatiquement inscrit(e) à un tirage au sort qui vous permettra de remporter un prix LEGO®.

Offre soumise à conditions.

Al contestar, participarás automáticamente en el sorteo y podrás ganar un set LEGO®.

Sujeto a Términos y Condiciones.

完成我们的反馈调查，即可自动进入抽奖环节，赢取乐高®套装。

适用《条款和条件》。

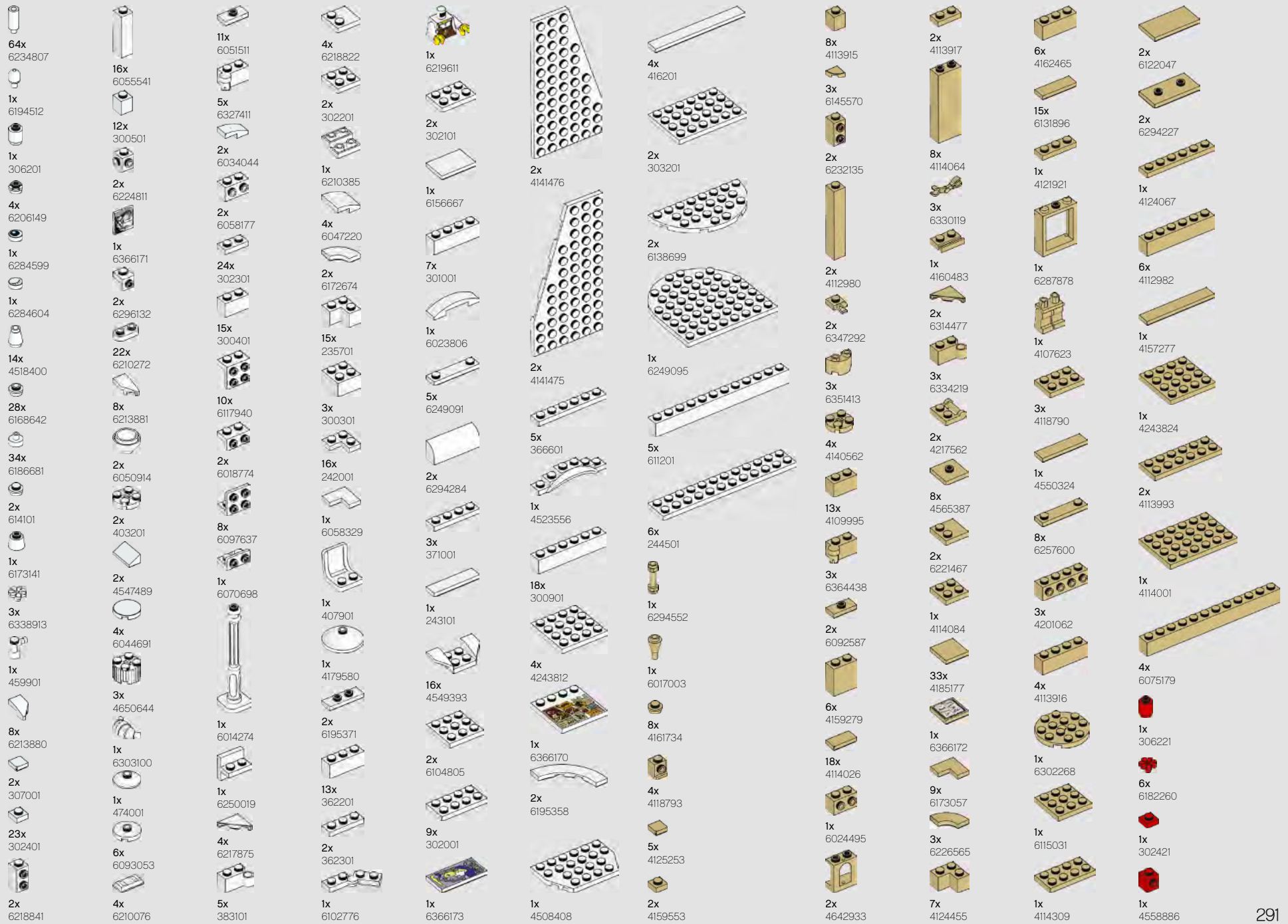

1x 302321	2x 6092582	1x 6218235	2x 6210496	1x 6224071	1x 6323420	1x 6323421	1x 6323421	1x 6092585	5x 4565323	1x 4613153	1x 6327402	1x 6357937	8x 6252258
1x 302221	1x 300423	1x 4651443	9x 6321194	12x 6371584	1x 6323421	1x 6323421	19x 6092585	1x 368026	1x 368026	11x 371026	1x 303426	6x 4616027	26x 6254552
2x 242021	1x 302323	1x 6116616	2x 6240496	1x 6173105	1x 6024730	1x 6138173	1x 6013867	1x 6013867	1x 6013867	4x 6037746	1x 303426	5x 4614158	1x 6278710
4x 4567445	2x 4558606	1x 6103171	1x 4529236	1x 6299338	1x 6024730	1x 6138173	1x 4124096	1x 4124096	1x 4124096	2x 243126	1x 395826	2x 6186009	1x 6278710
1x 6061711	3x 362223	1x 6288015	1x 6056234	4x 6308000	1x 6269081	1x 306926	5x 6052126	2x 6052126	2x 6052126	1x 611517	2x 447726	2x 6186423	2x 6251285
2x 362321	2x 4587840	1x 6211710	3x 6056234	15x 6380639	1x 6102341	2x 6147050	2x 4515368	2x 4515368	2x 4515368	4x 611517	4x 447726	23x 6253425	2x 6251285
2x 6268946	2x 428623	2x 307024	19x 6168646	1x 6134617	1x 6092664	3x 6000650	1x 407926	1x 407926	4x 6138726	4x 4558593	14x 6150607	2x 6257603	3x 6256058
1x 302121	1x 317623	3x 300524	10x 6186675	2x 6336977	1x 6070695	1x 6250020	2x 6272184	2x 6272184	1x 6280168	1x 6138726	1x 403228	5x 6074892	3x 6256058
1x 4515348	4x 6102759	2x 389924	6x 614126	4x 6104209	2x 6057397	1x 6285241	1x 6219624	1x 6219624	1x 302026	1x 6280168	1x 6269971	21x 6074893	4x 6247362
1x 6313597	2x 300223	2x 6029947	3x 6195183	2x 6281993	1x 4105175	16x 6214807	1x 6219624	1x 6219624	1x 663626	1x 302026	1x 6261358	4x 6058089	4x 6247362
1x 302021	1x 371023	1x 242024	2x 6195183	1x 6079896	1x 6366174	4x 6252201	1x 317626	1x 317626	1x 663626	1x 663626	6x 6129807	4x 6058089	7x 6253734
2x 614123	1x 371023	1x 371024	2x 389924	2x 6312449	2x 6195325	1x 6336989	2x 6116604	2x 6116604	1x 6162892	1x 6058118	3x 371028	6x 6253418	4x 6244793
2x 6344028	1x 371023	7x 302426	2x 6029947	4x 6273589	1x 4106552	1x 6151289	1x 6162892	1x 6162892	1x 6162892	1x 6344427	17x 6182261	2x 6166107	4x 6240216
1x 300523	1x 6262960	10x 6335388	1x 242024	4x 6273589	2x 249626	1x 6093525	1x 6162892	1x 6162892	1x 6344427	1x 6344427	10x 6143431	1x 6168665	2x 6337597
3x 370023	1x 6366175	2x 6172383	1x 371024	2x 300526	1x 6308032	1x 6151289	1x 6162892	2x 6286835	1x 6344427	1x 346026	17x 6369194	1x 6168665	2x 6337597
292		5x 6290456	2x 6170421	2x 6289987	4x 6157554	2x 249626	1x 6186698	1x 383926	1x 416226	1x 416226	2x 6248949	6x 6244796	2x 6247364

4x
4211002

1x
4210998

1x
4211115

1x
6141856

3x
4210794

1x
6107399

1x
6092833

1x
4586410

38x
6369191

31x
6357797

1x
6275872

57x
6369188

43x
6369189

2x
6357796

2x
6343511

14x
6325881

1x
6297283

5x
6357794

14x
6369190

35x
6378419

9x
6369187

4x
6369192

1x
6170470

1x
6292254

4x
6252838

6x
6296657

5x
6209691

4x
4529247

1x
6190252

5x
6186672

5x
4523159

1x
6284379

6x
6257048

2x
6167585

2x
4490599

1x
6245261

1x
6092594

2x
6022033

5x
6093529

3x
6147169

4x
6226437

6x
6251021

5x
4519970

6x
4566688

2x
6046943

4x
6058221

17x
6058257

1x
4538950

1x
6179803

2x
6047037

4x
6272145

1x
6167928

2x
6313874

3x
6252667

2x
6328181

4x
6226792

1x
6295366

4x
4518687

5x
6300103

4x
6167641

26x
6057986

1x
6167690

7x
6215606

3x
6177146

7x
6314190

41x
4656783

6x
6021997

4x
6186400

2x
4568955

17x
6223183

6x
6102998

8x
6218359

47x
6099341

1x
6295464

4x
6106193

2x
6387478

1x
6345302

3x
6102990

4x
6102994

1x
6177535

6x
6192922

4x
4633691

4x
4619636

1x
4611884

3x
4655243

4x
6136419

4x
6331949

4x
6119126

1x
4624705

1x
6253666

2x
6361352

8x
6251591

6x
6295242

1x
6240515

Customer Service
Kundenservice
Service Client
Assistenza clienti
Atención al cliente
Serviço de Apoio ao Consumidor
Ügyfélszolgálat
Klientu apkalpošanas dienests
Serviciul pentru clienț
客户服务
コンシューマーサービス
고객 서비스
LEGO.com/service

10278

10297

10270

