

The background of the entire page is a detailed white line-art illustration of the Eiffel Tower's internal structure, showing a large archway and a grid of beams and bolts. In the center of the arch, there is a small icon of the tower's top section.

Eiffel tower

Book 2

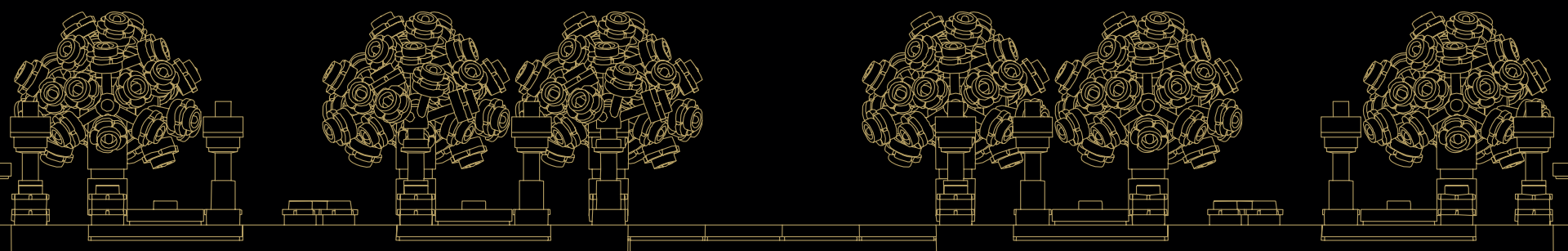

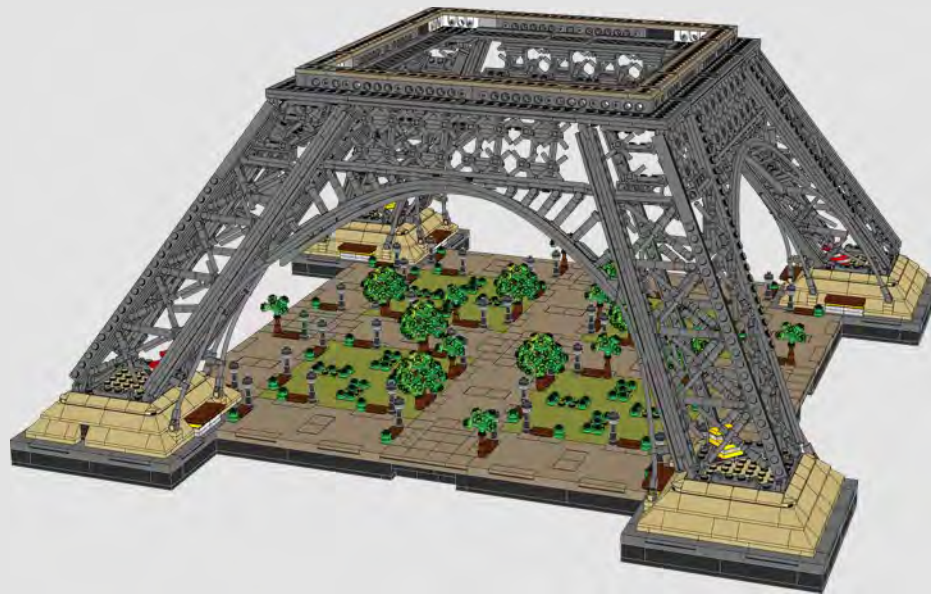
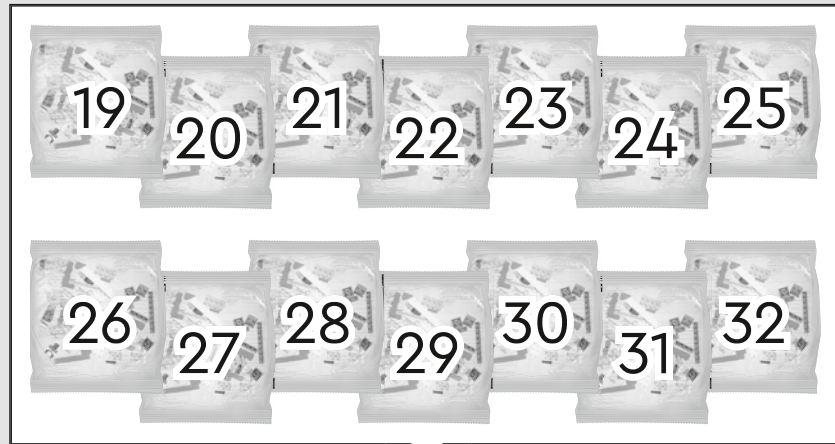

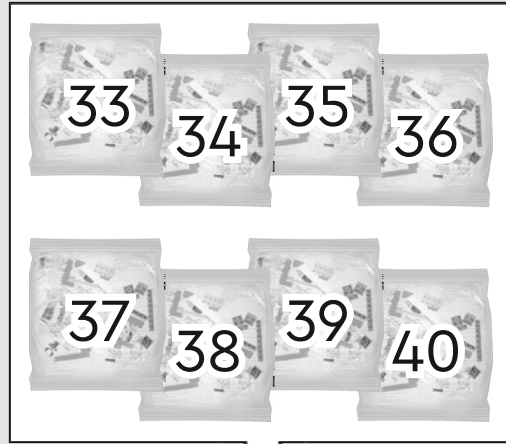

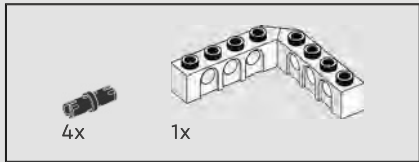
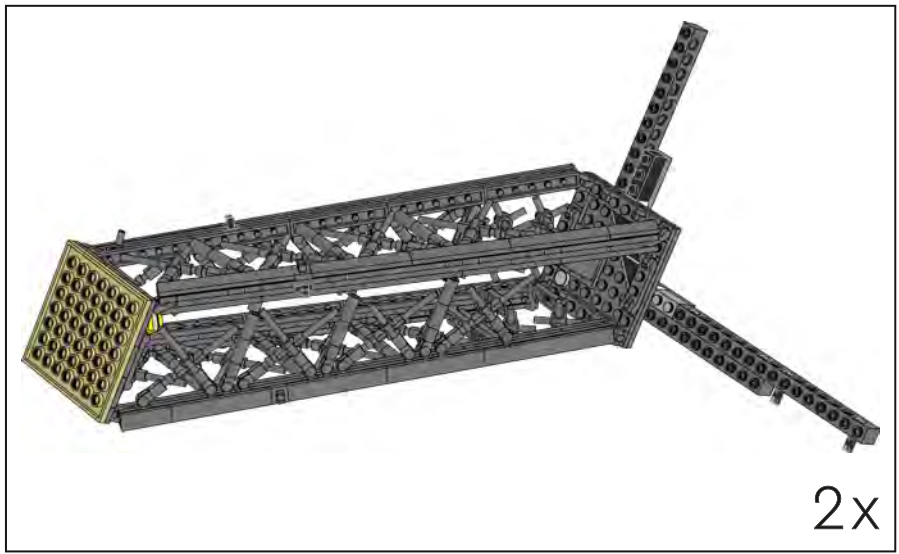

88

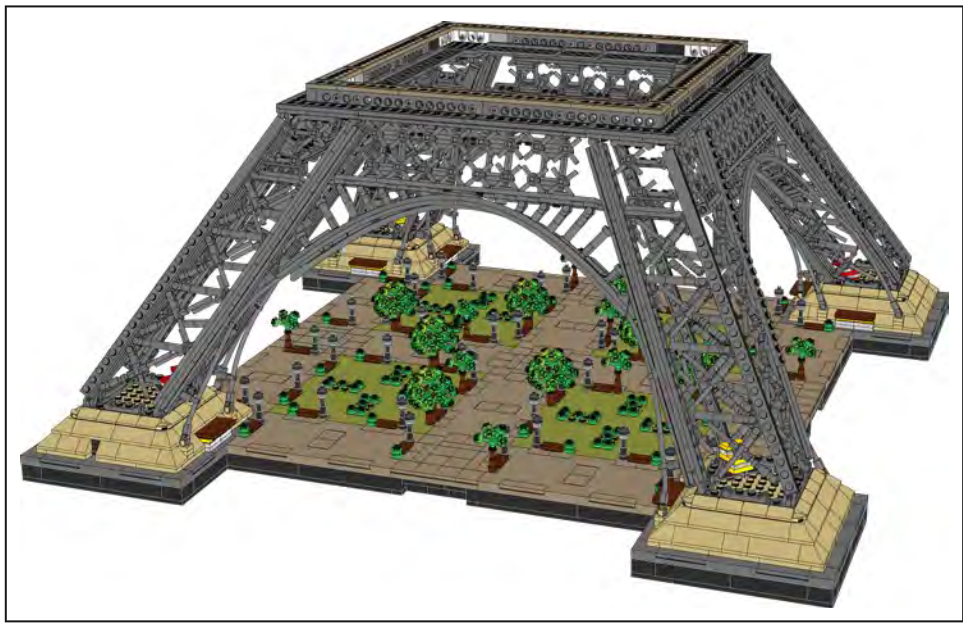
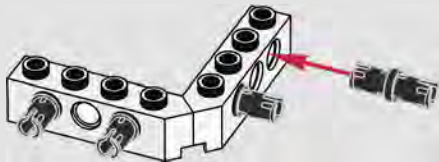

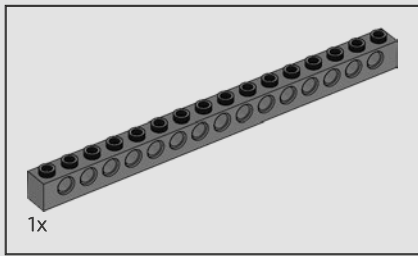

89

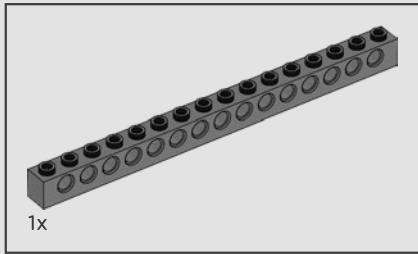

90

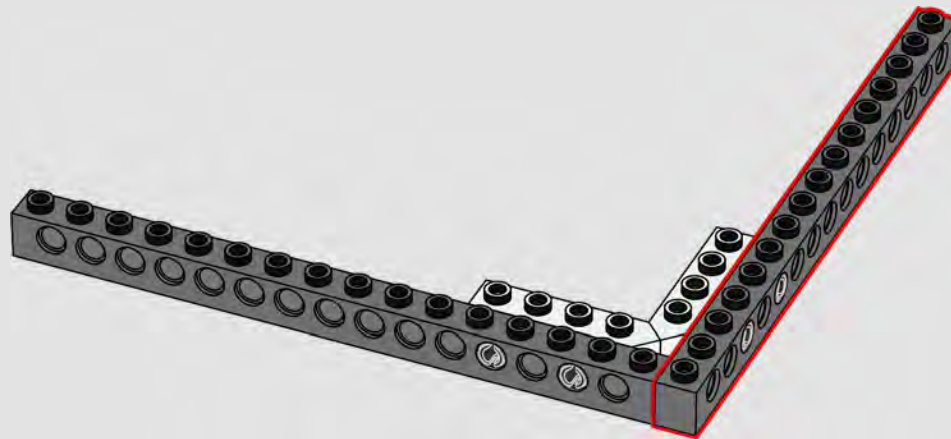

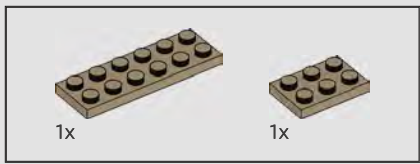

91

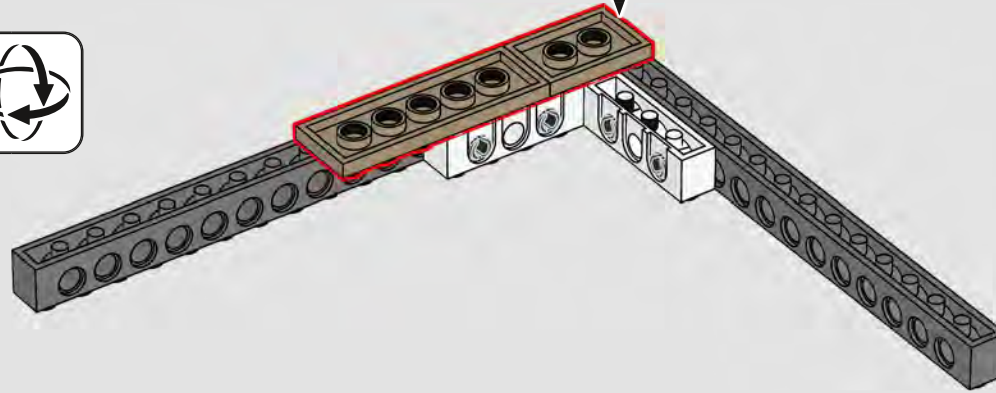
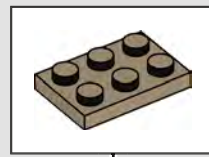

92

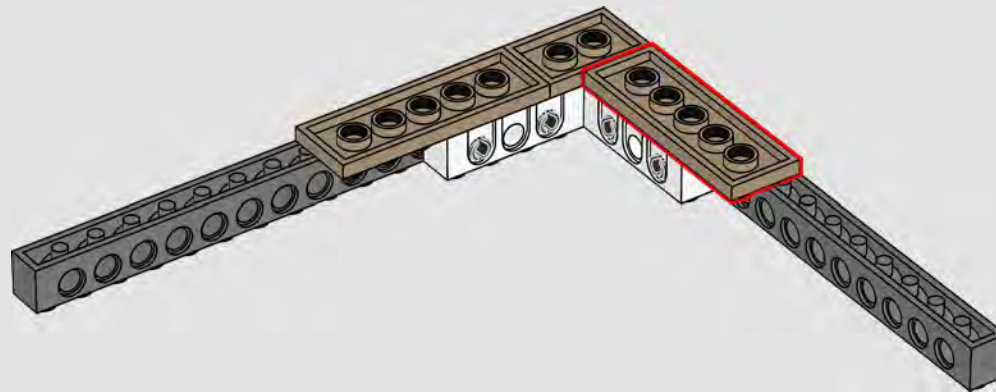

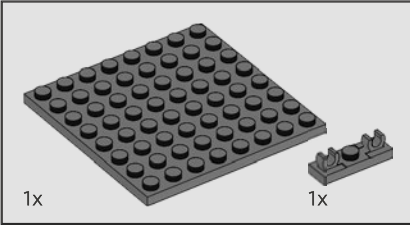

93

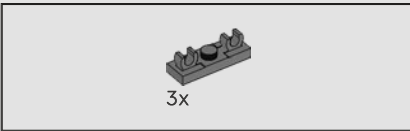
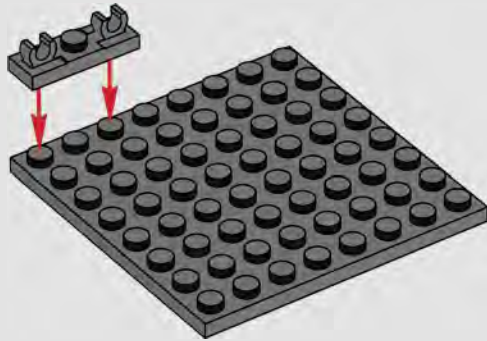

94

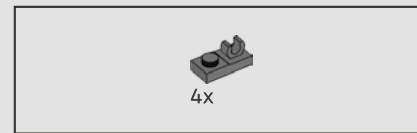
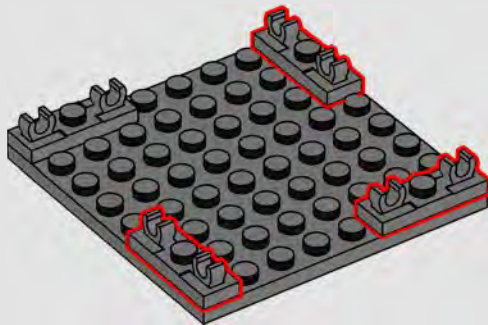

95

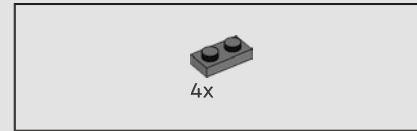
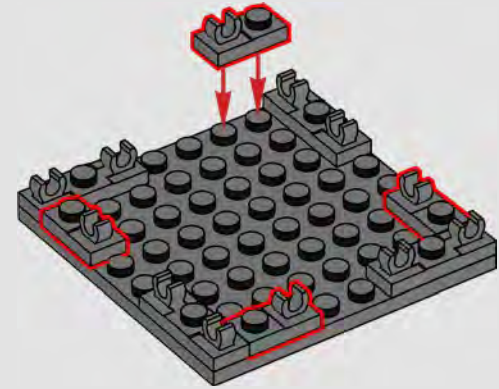

96

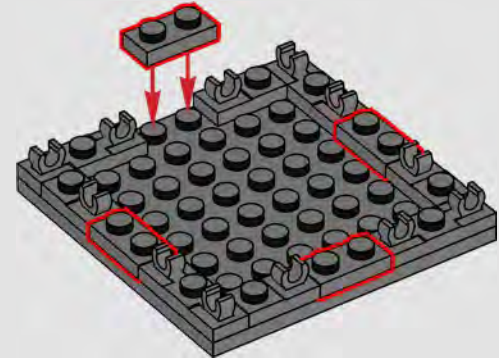

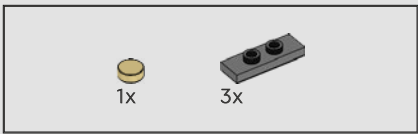

97

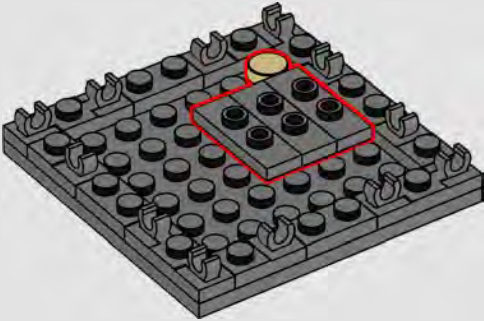

98

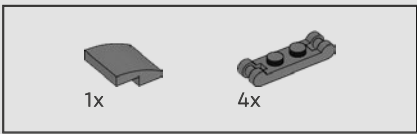
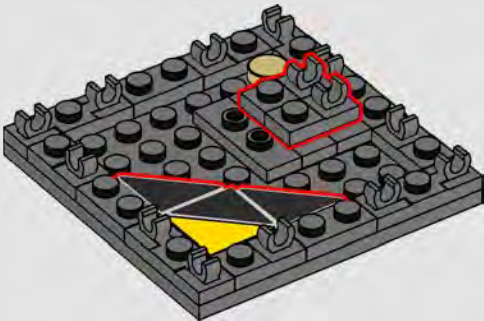

99

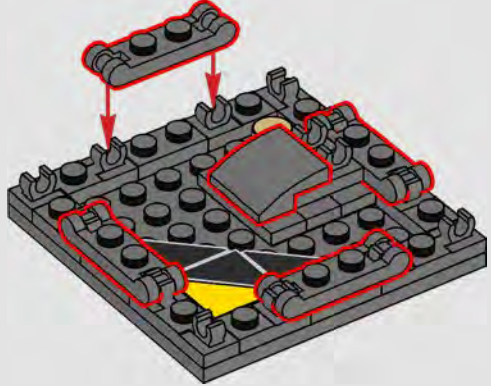

100

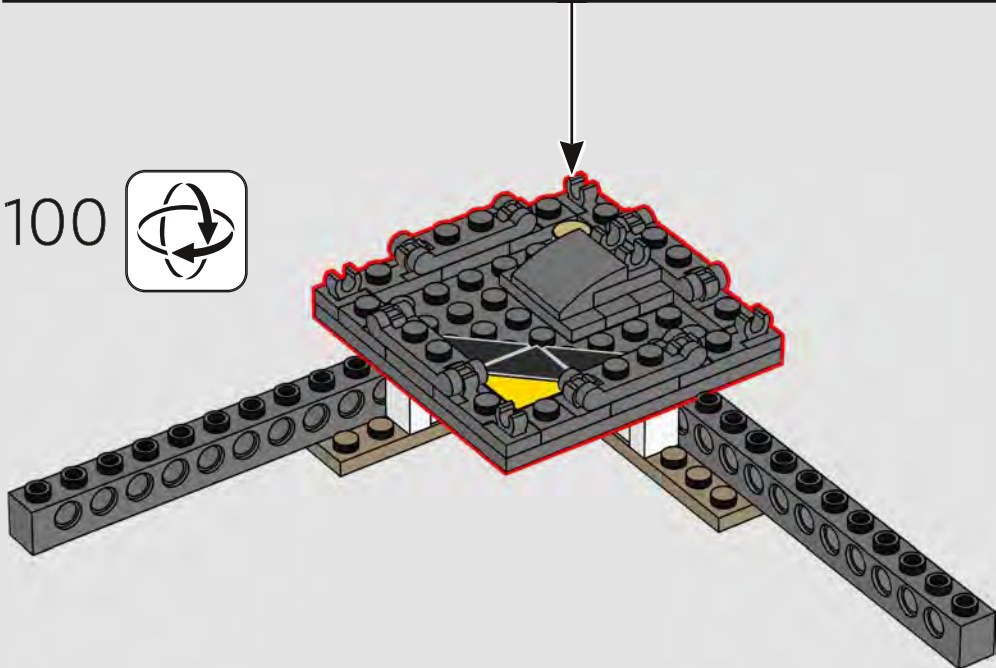

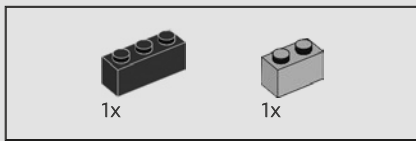

101

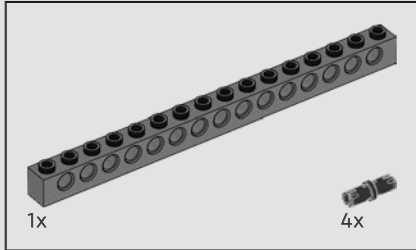
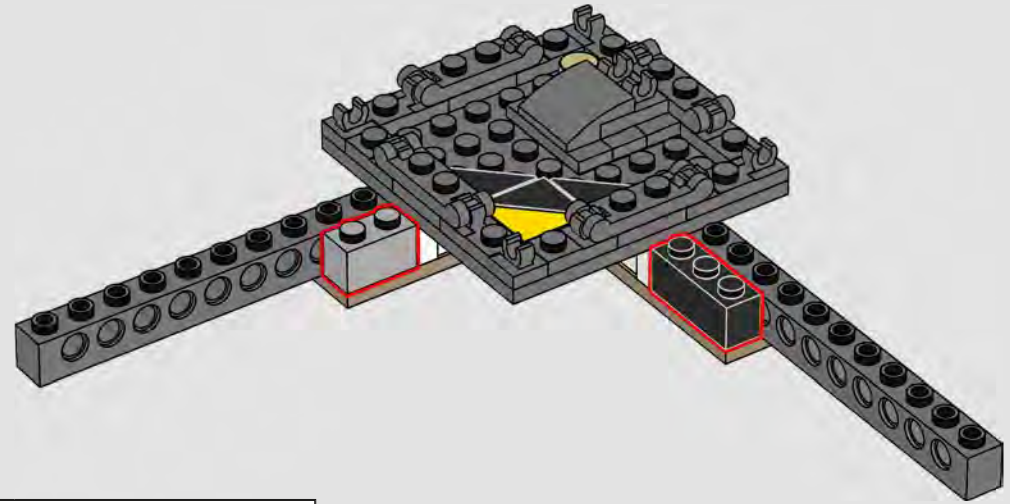

102

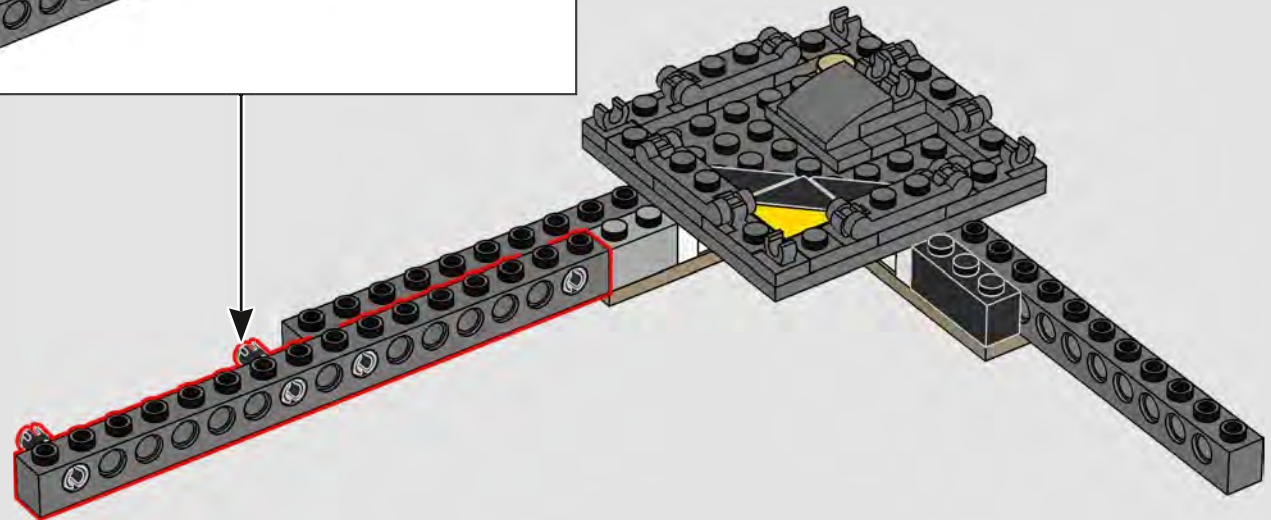
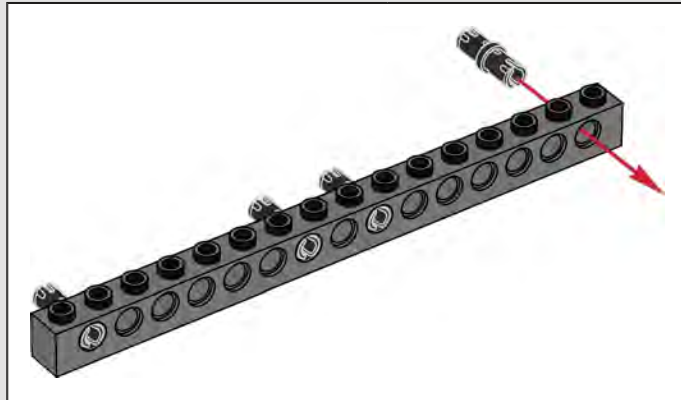

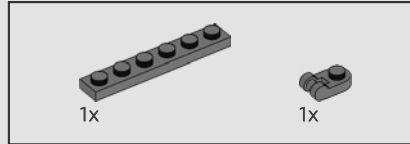
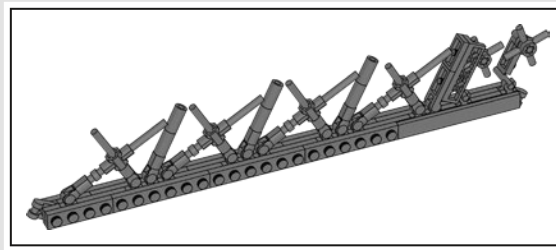

103

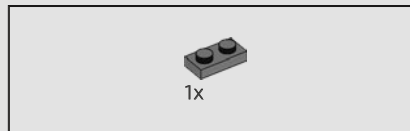
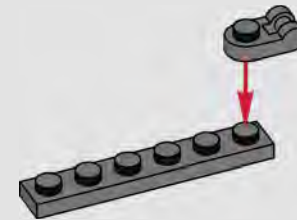

104

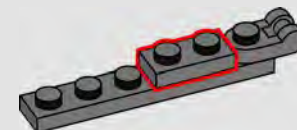

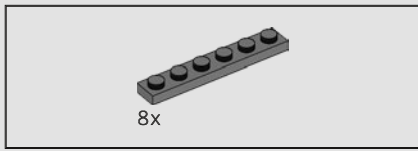

105

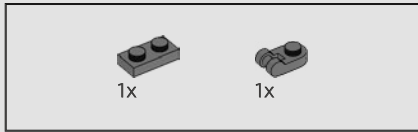
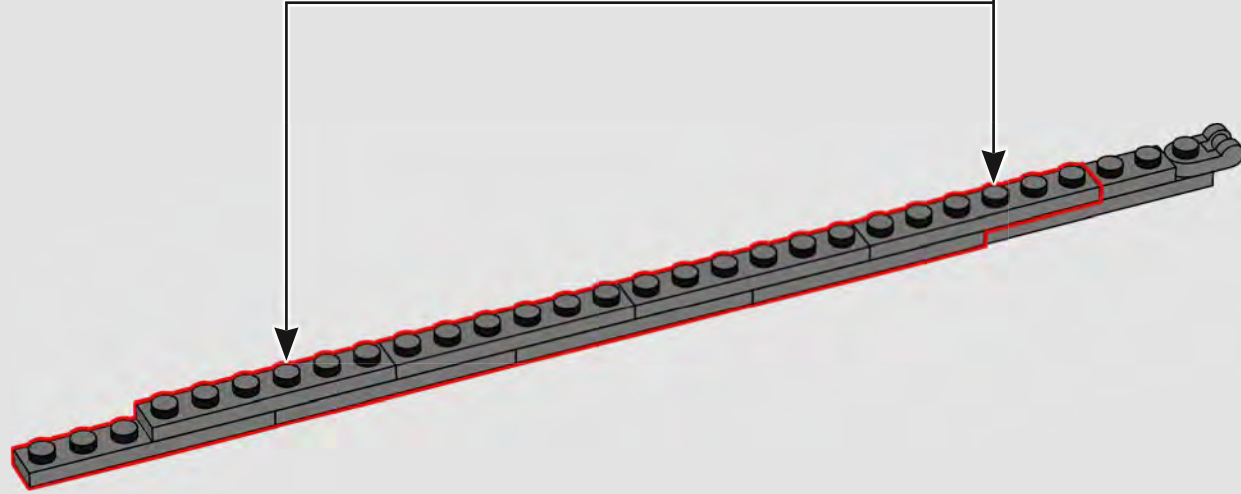
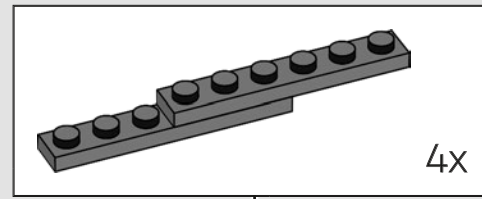

106

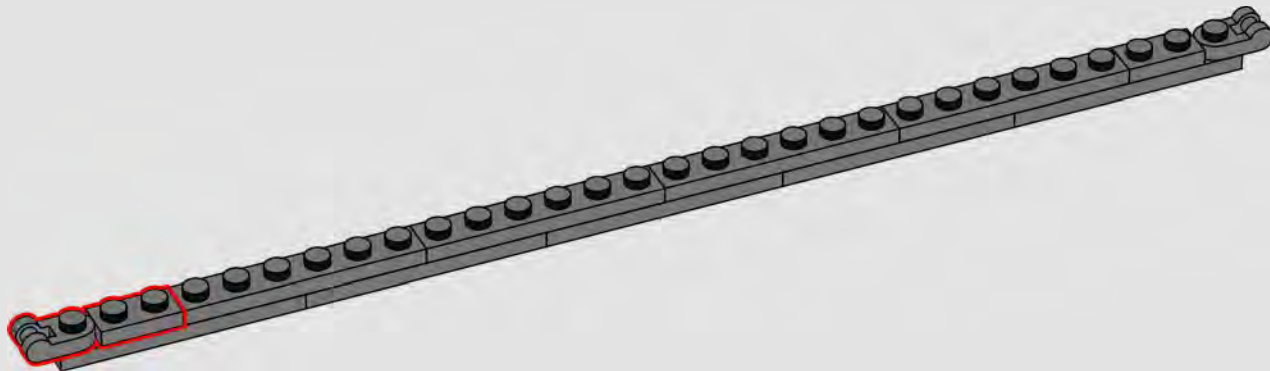

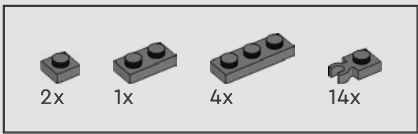

107

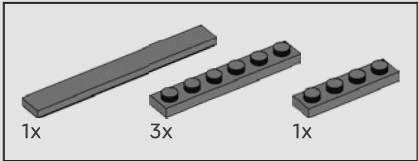
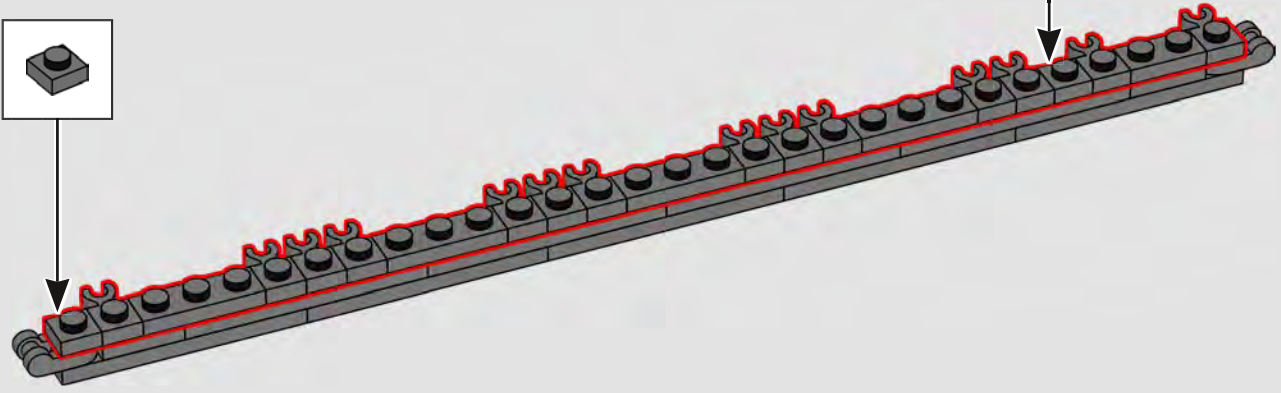
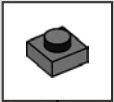

108

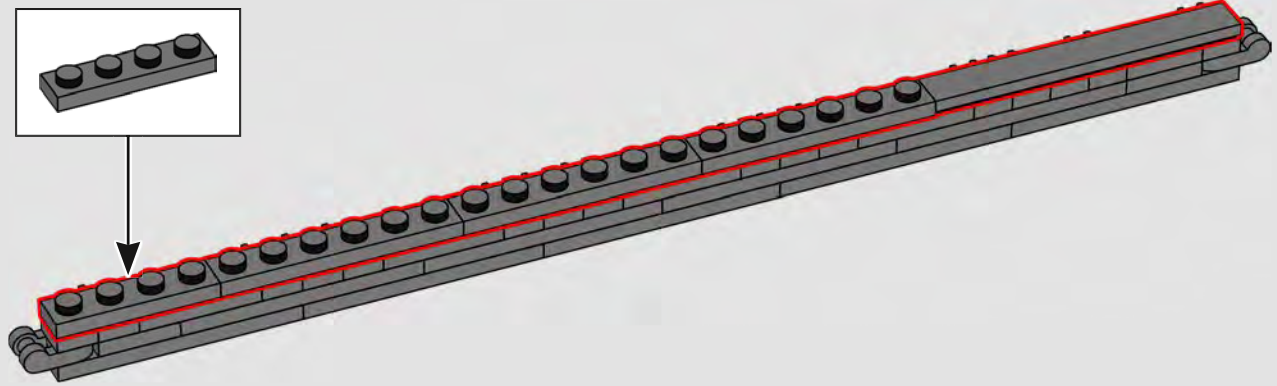
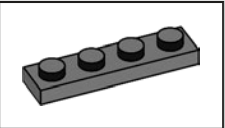

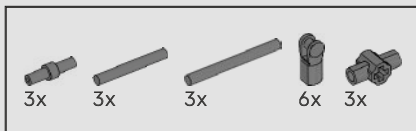

109

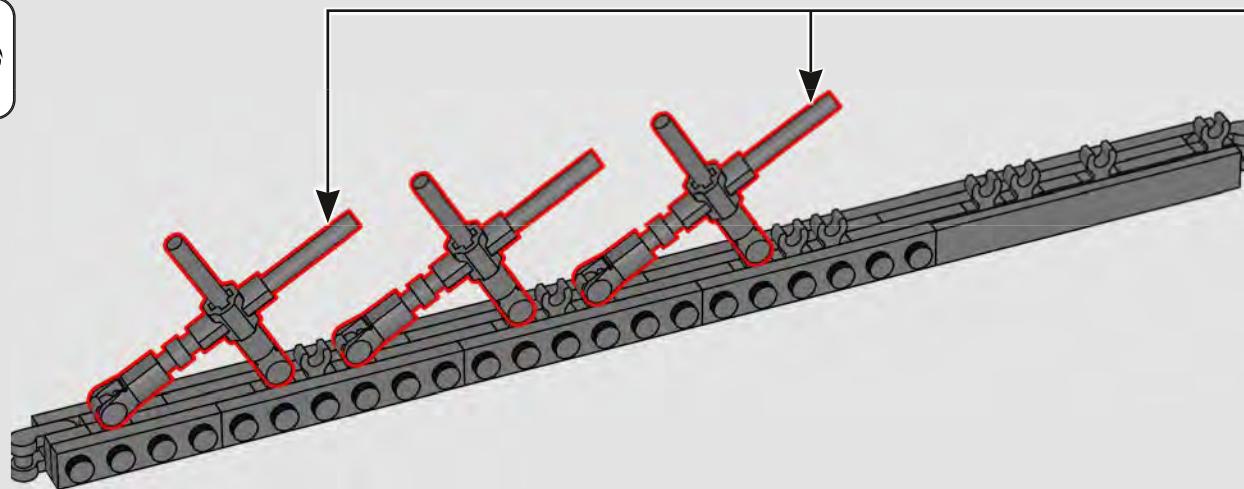
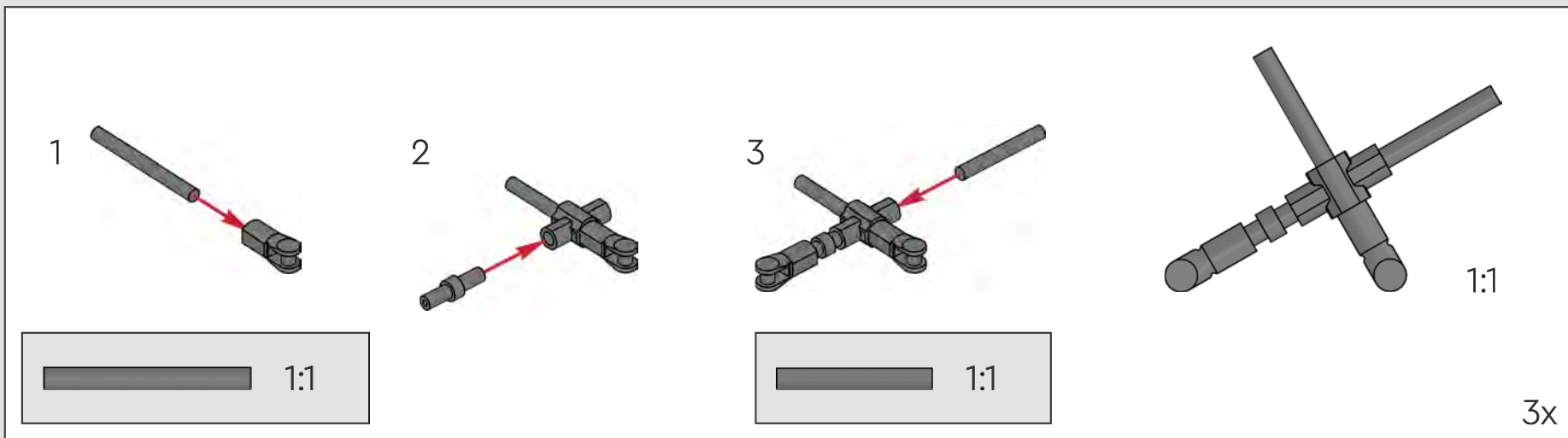

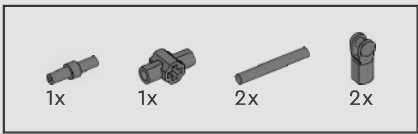

110

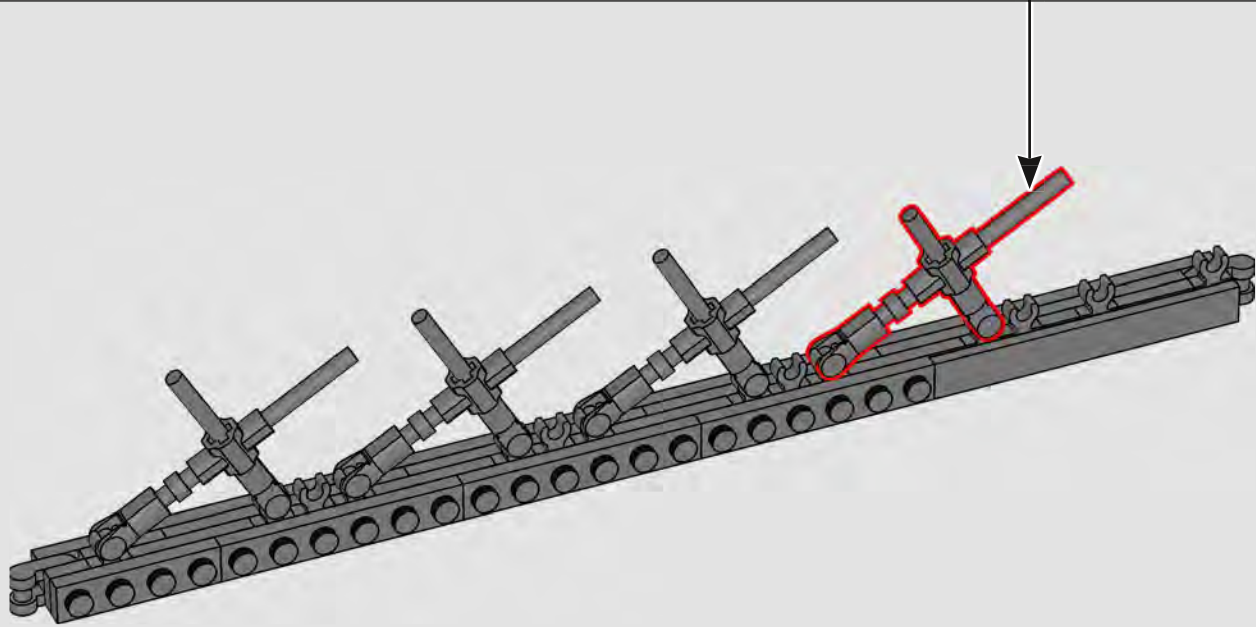
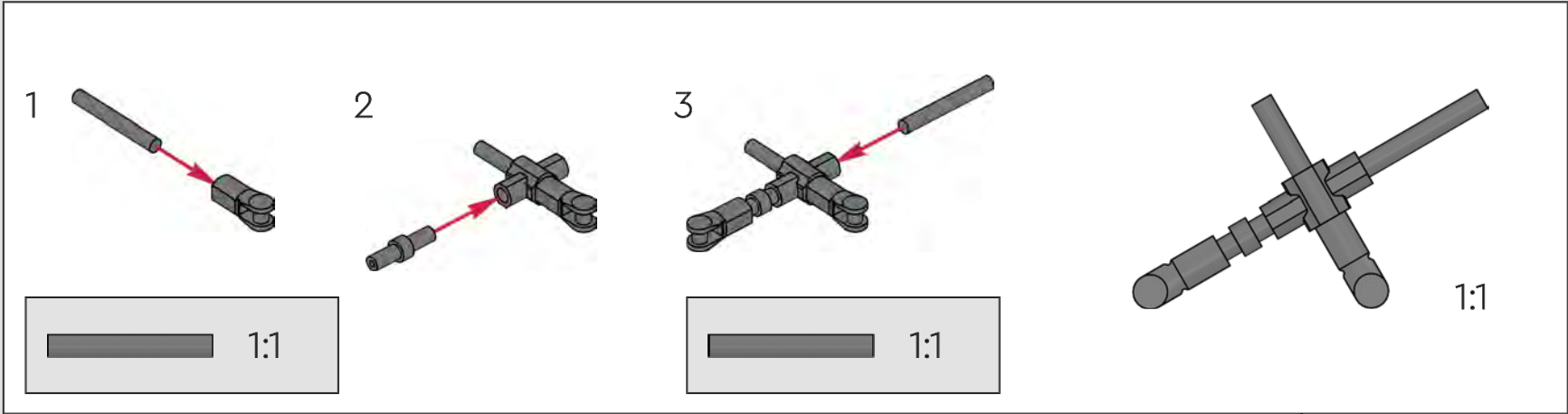

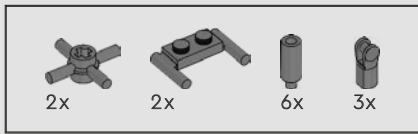

111

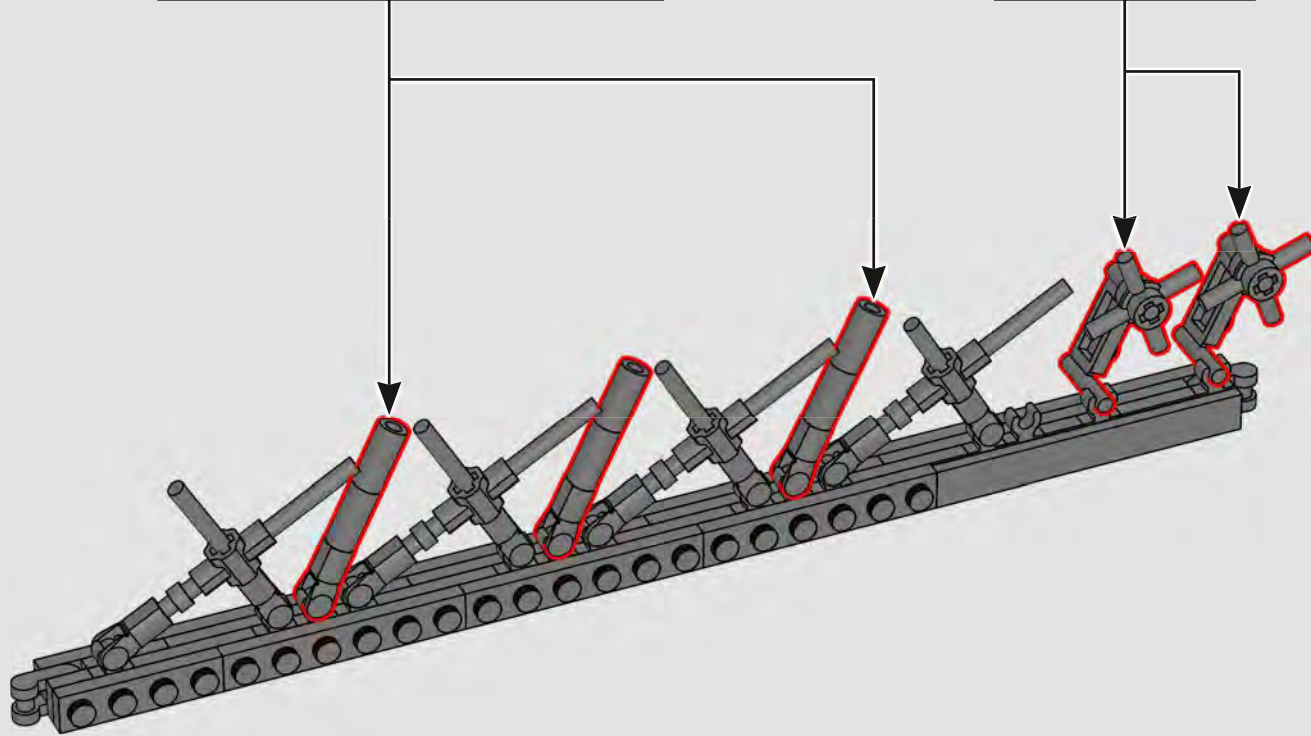
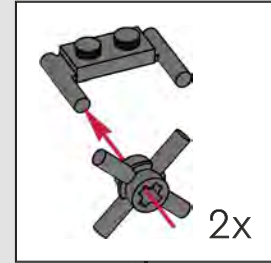
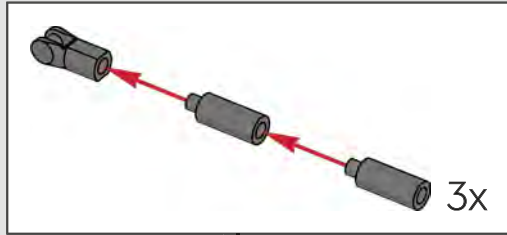

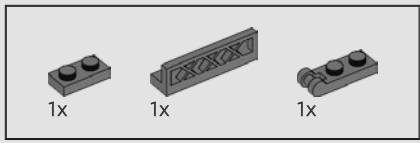

112

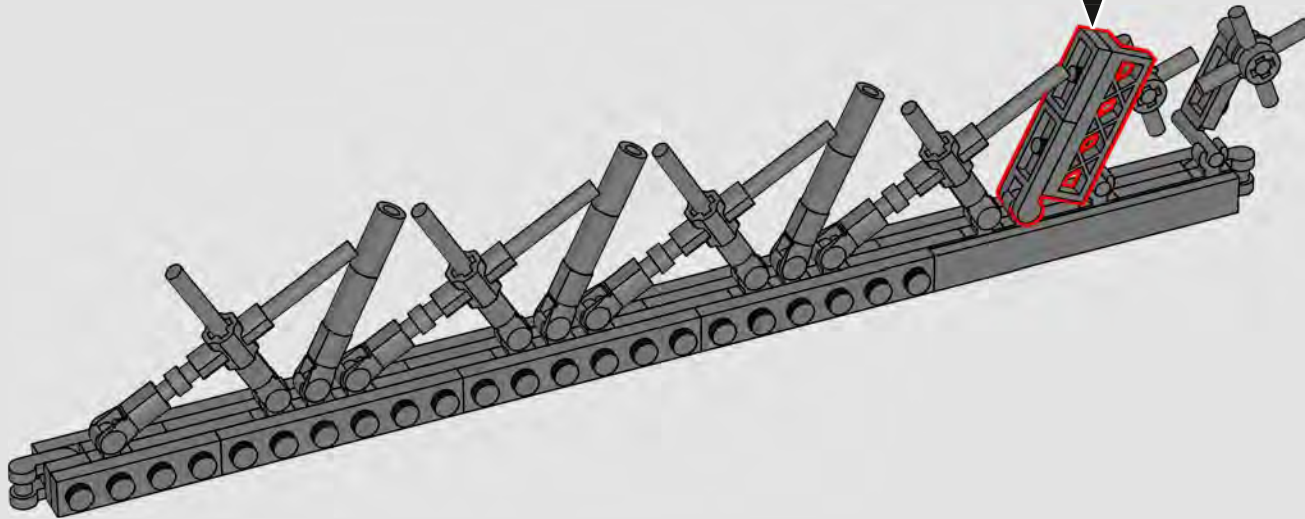
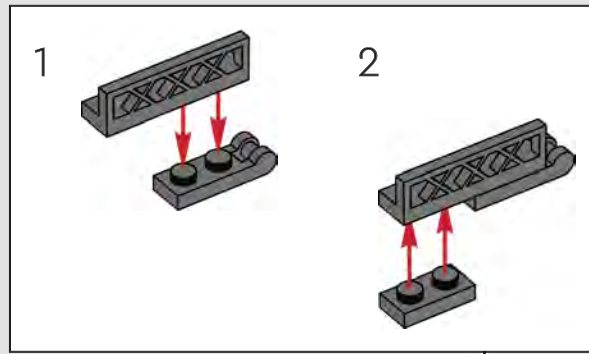

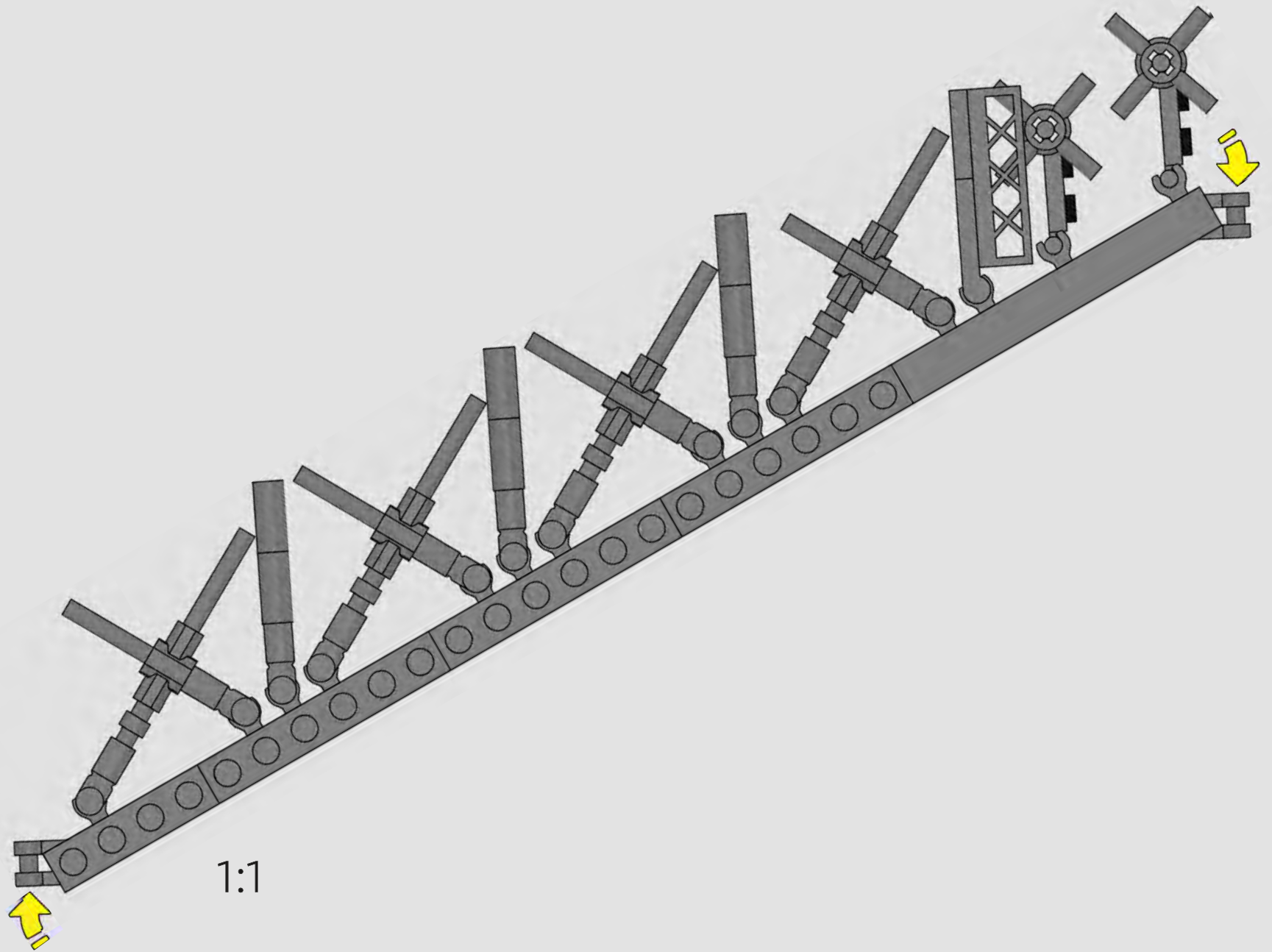

113

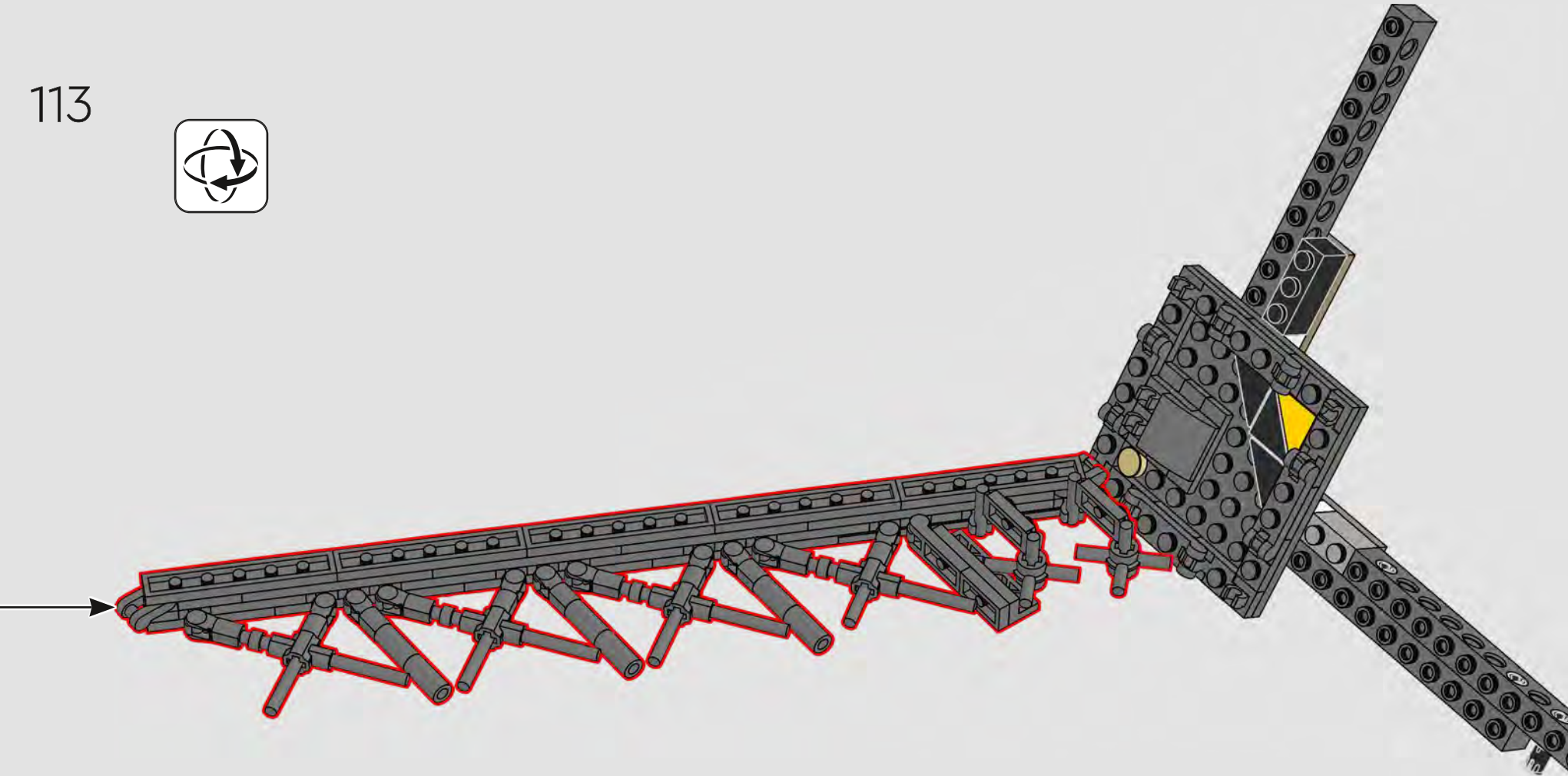

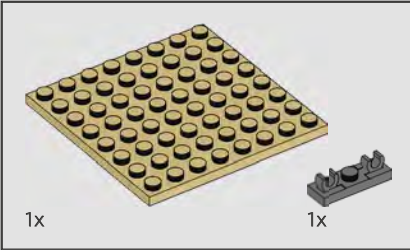
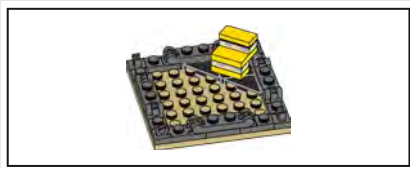

1x

1x

114

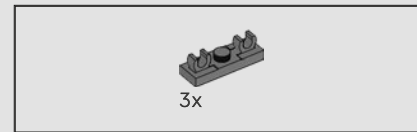
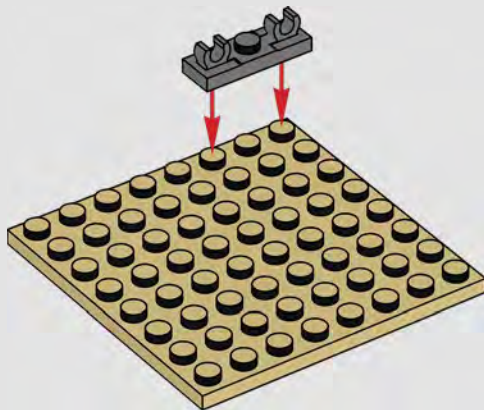

3x

115

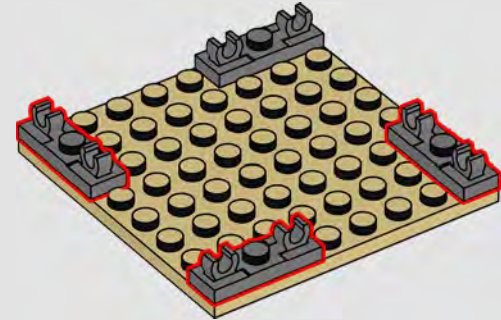

4x

116

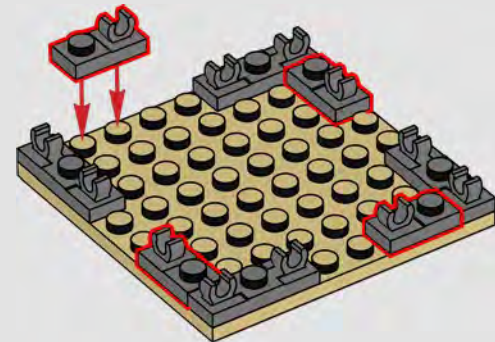



4x

117

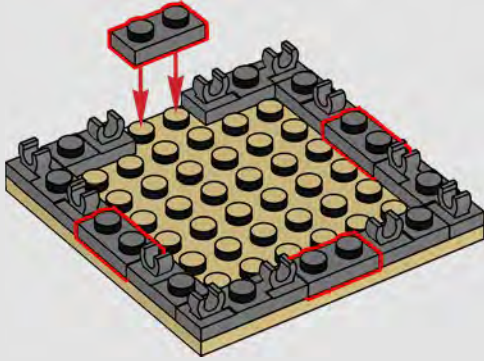

4x

118

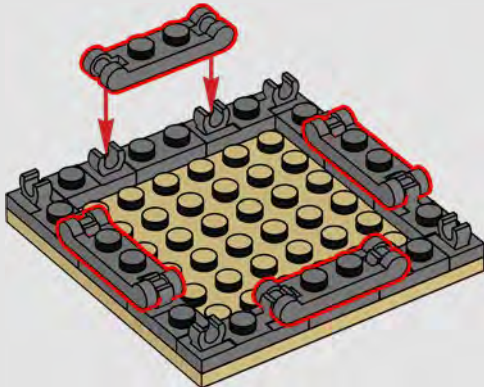

2x

1x

1x

119

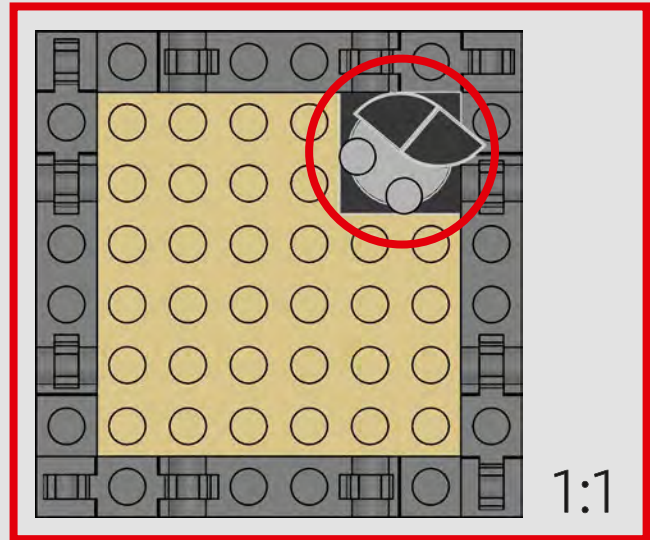
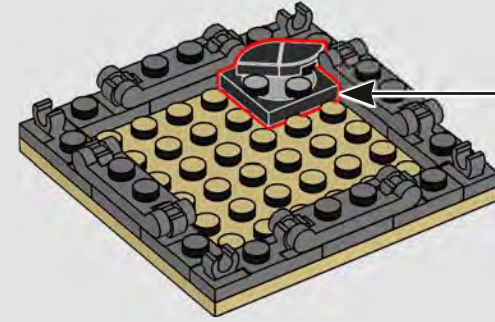



120

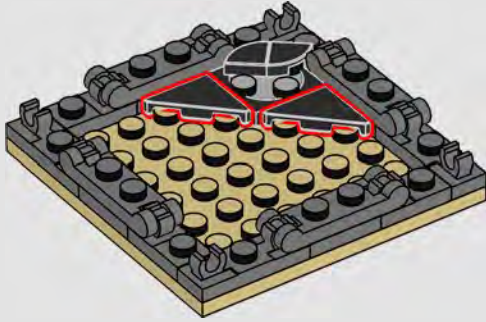

121

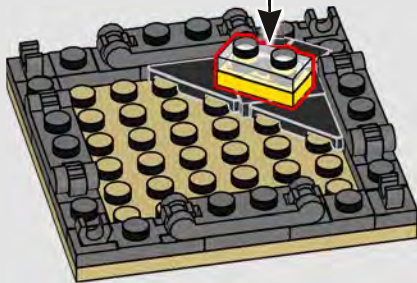
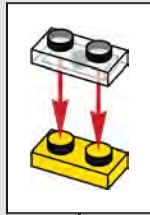

122

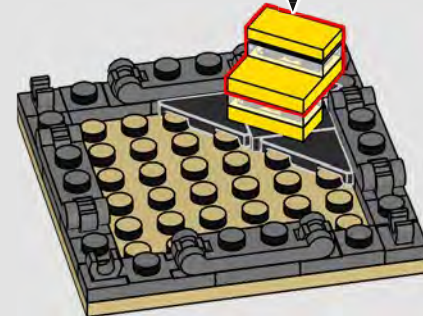
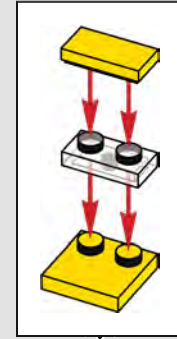

123

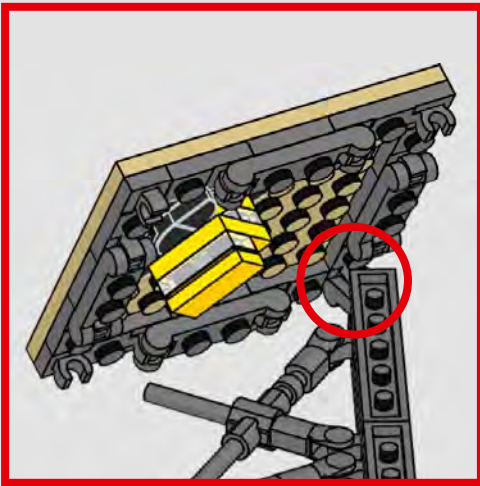

The two pairs of red and yellow double decker elevators in the model serve as colour guides to distinguish the north/south and east/west pair of legs.

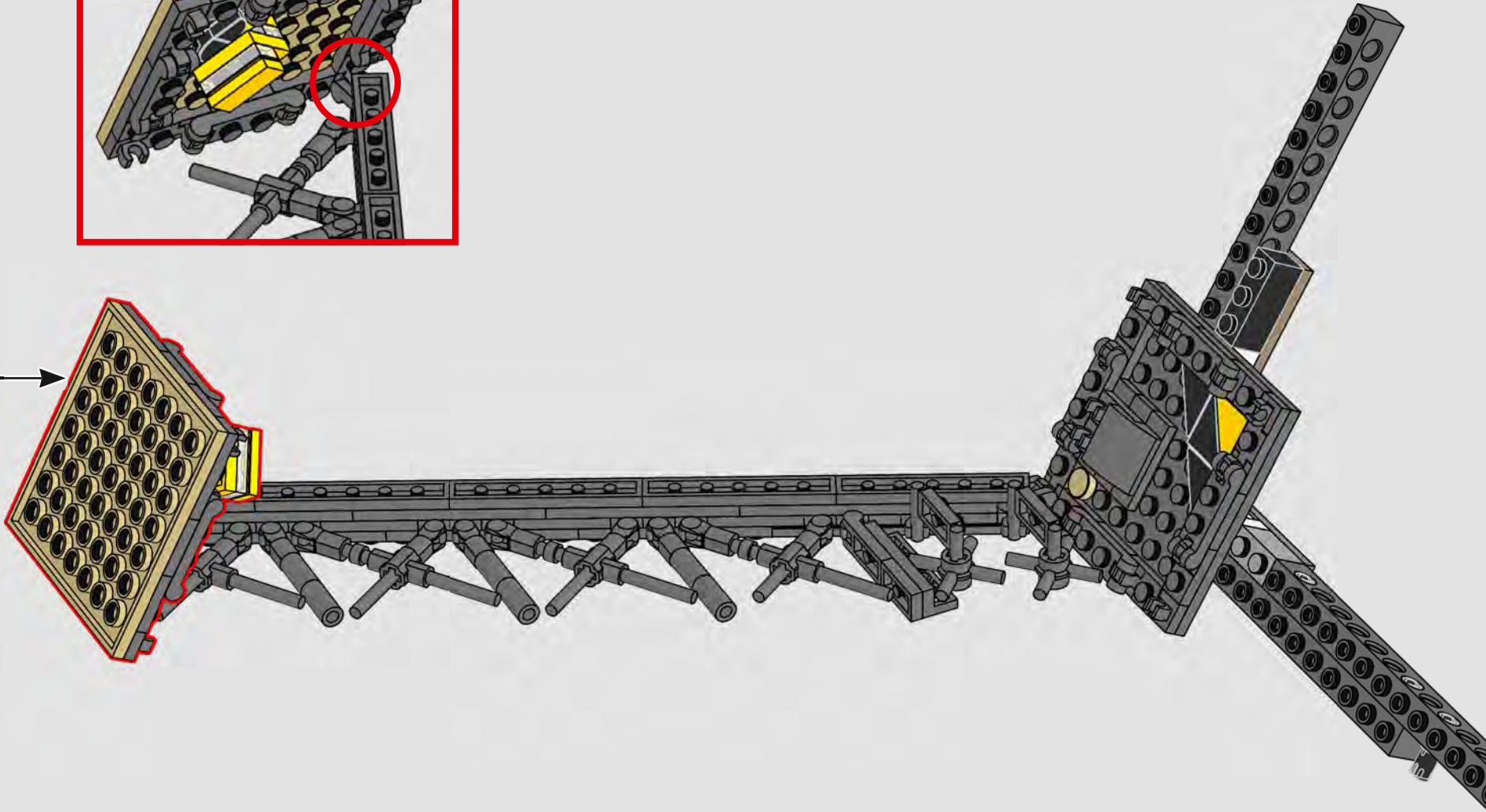

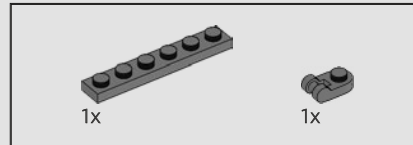
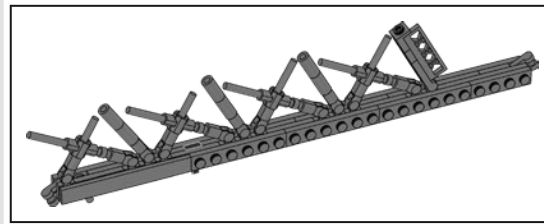

124

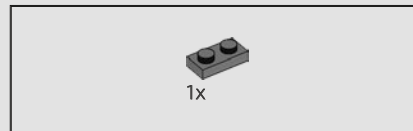
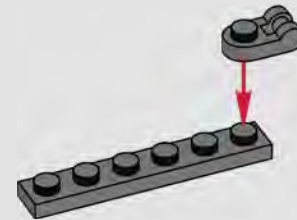

125

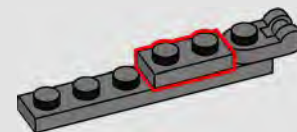

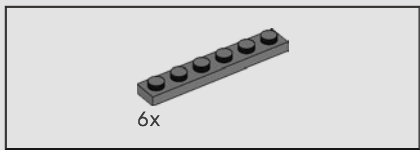

126

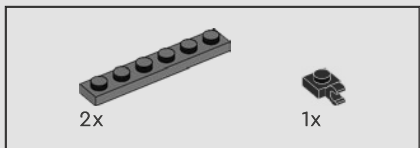
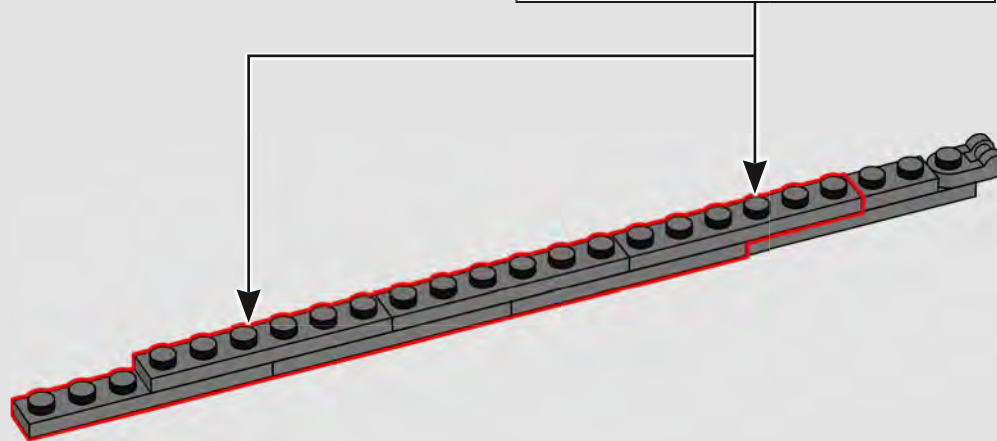
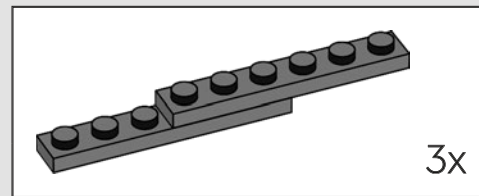

127

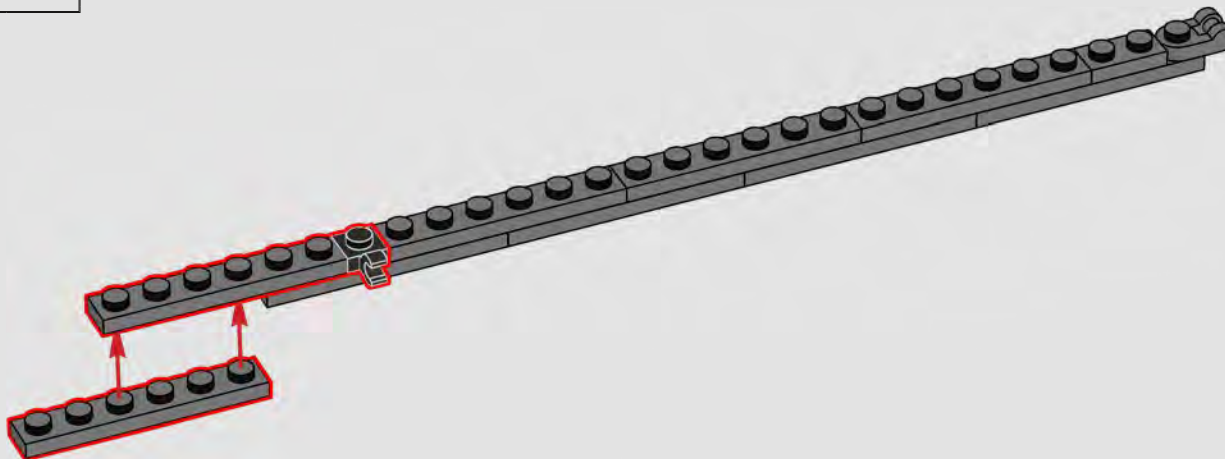

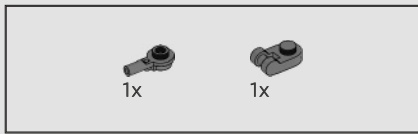

128

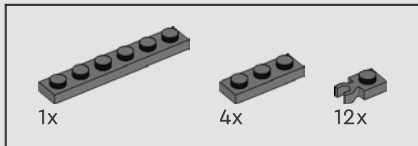
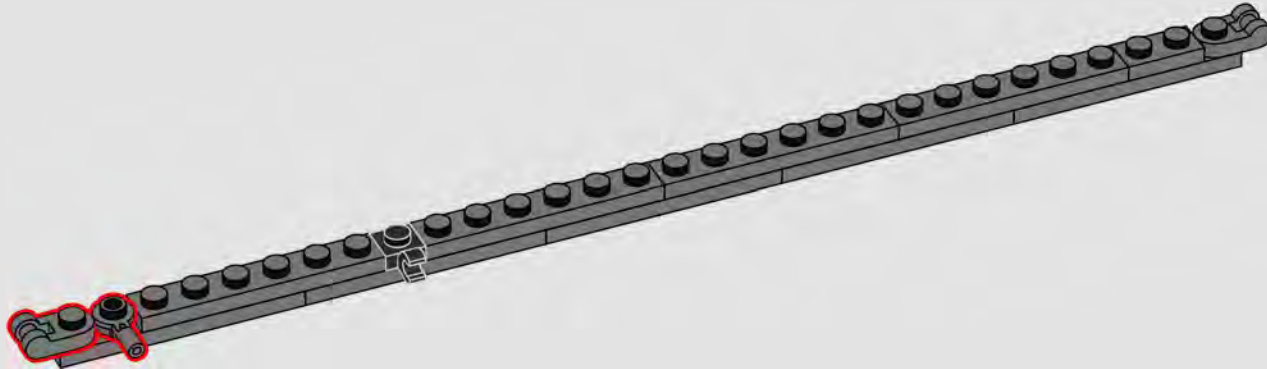

129

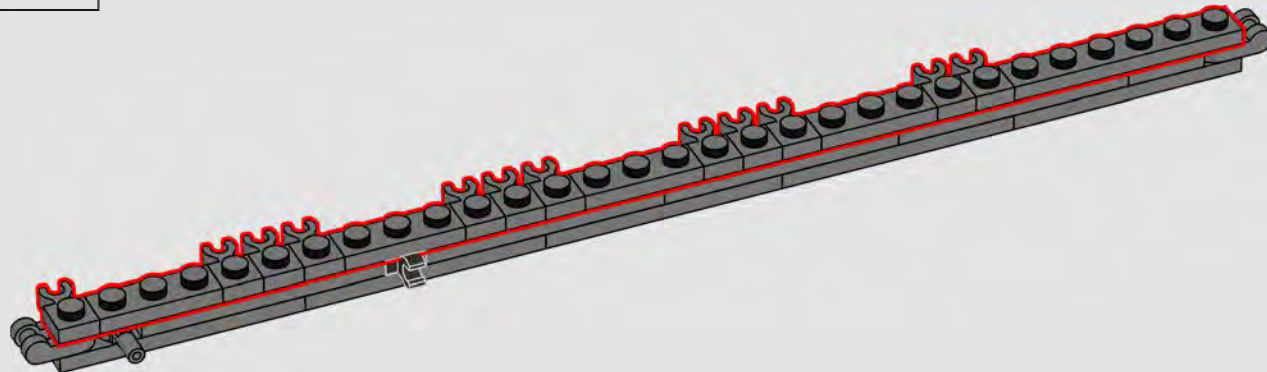

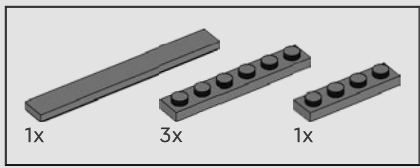

130

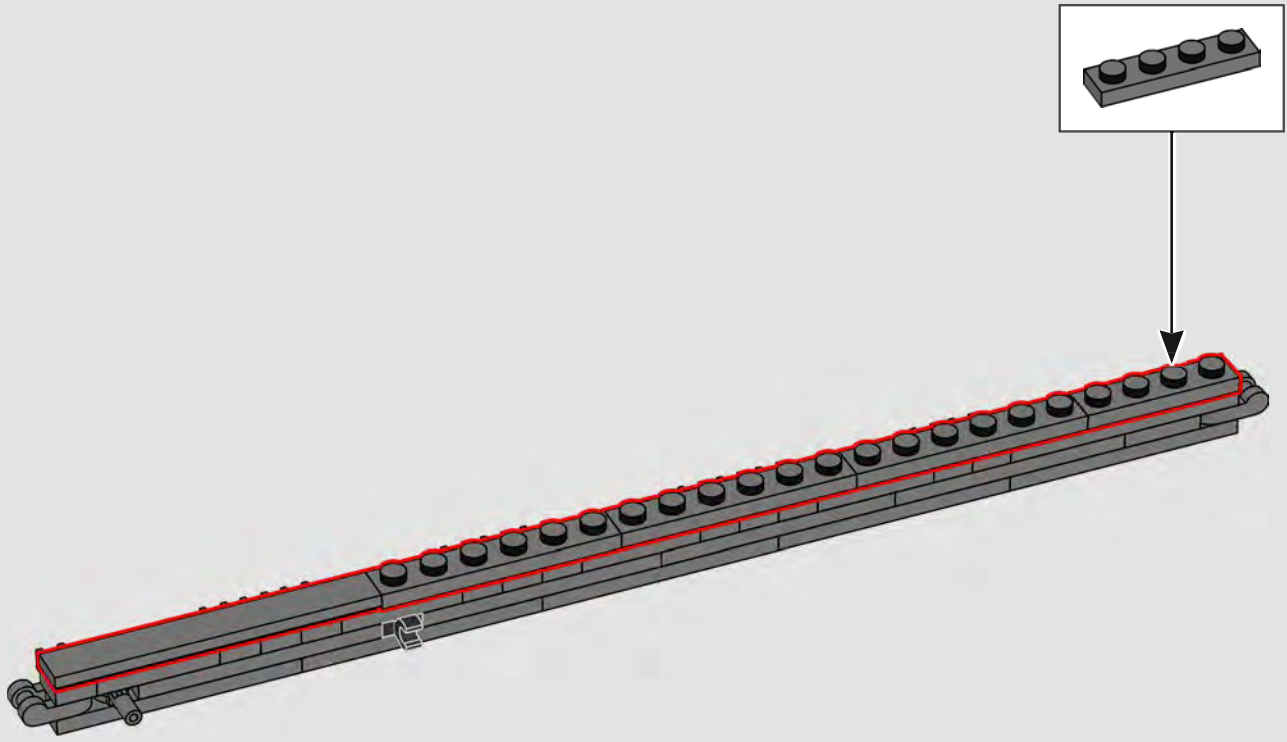

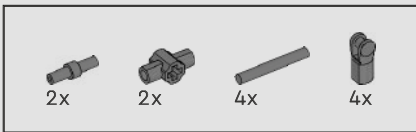

131

1 2 3

1:1 1:1 1:1 2x

Detailed description: This block contains three numbered steps (1, 2, 3) and a final assembly view. Step 1 shows a long axle being inserted into a connector. Step 2 shows a second connector being attached to the first. Step 3 shows a second long axle being inserted into the second connector. The final assembly view shows two of these completed cross-axle units. Below steps 1 and 3 are boxes containing a long axle and the ratio '1:1'. The final assembly view is labeled '1:1' and '2x'.

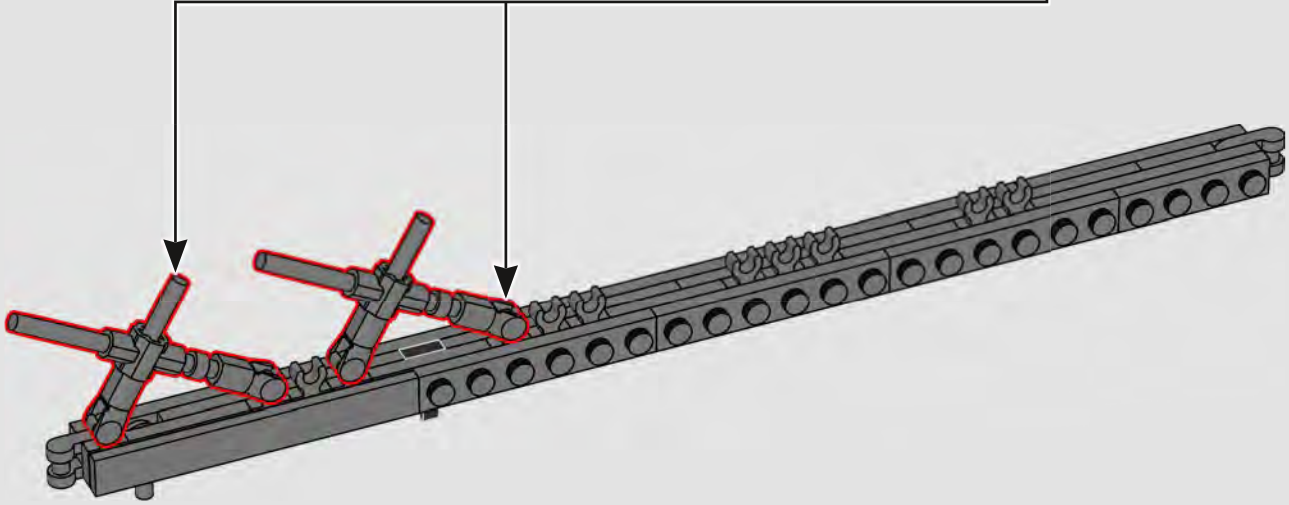

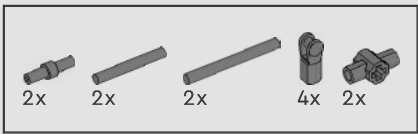

132

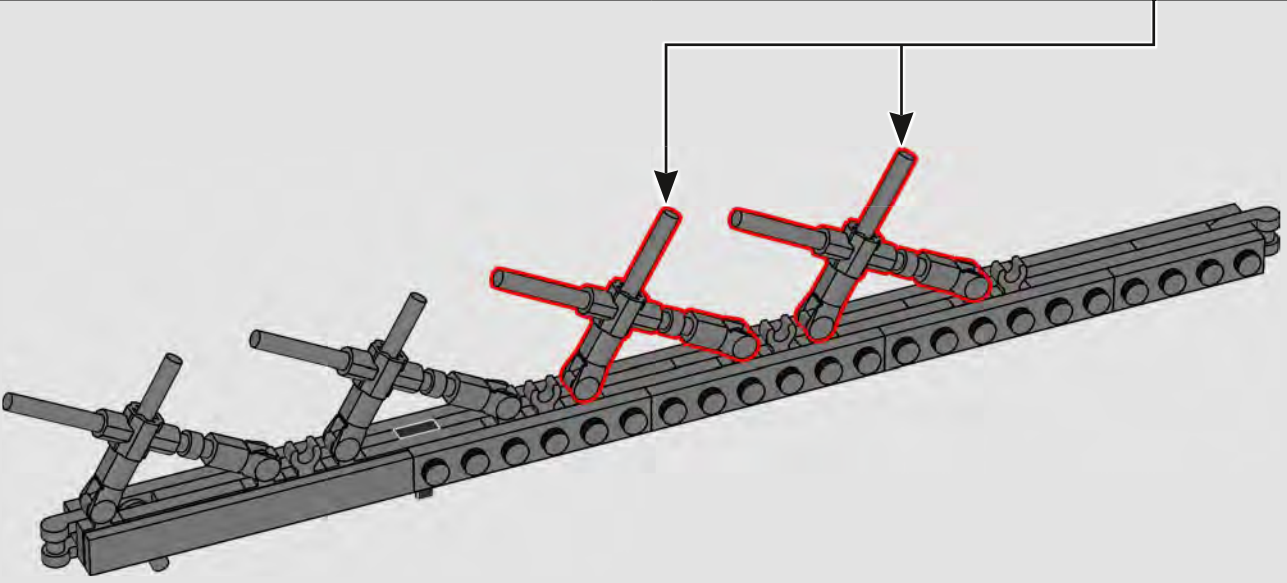
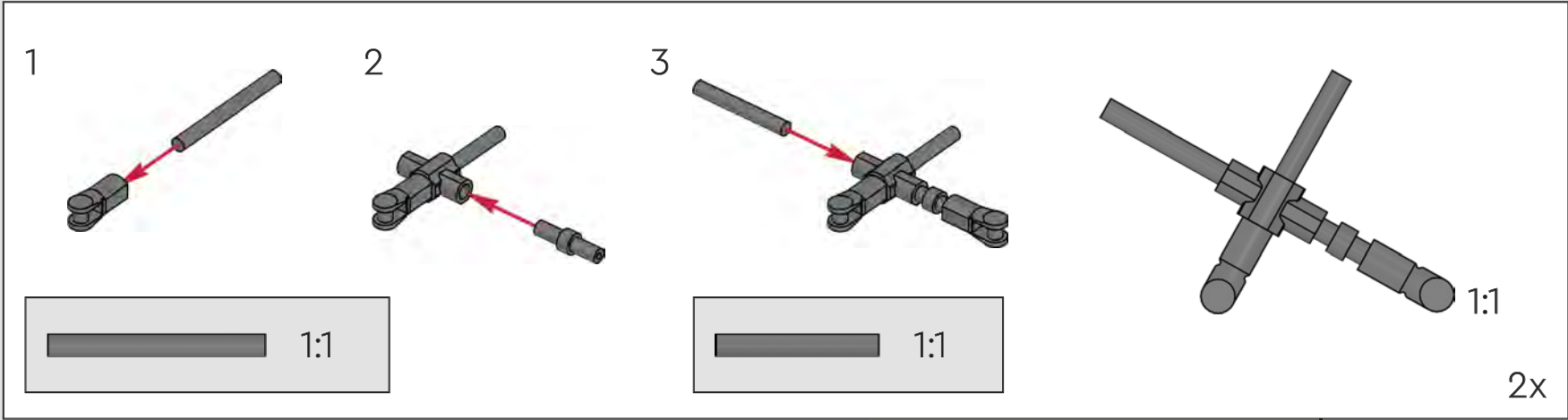

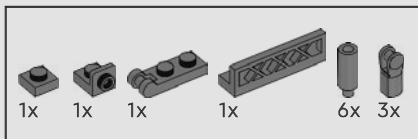

133

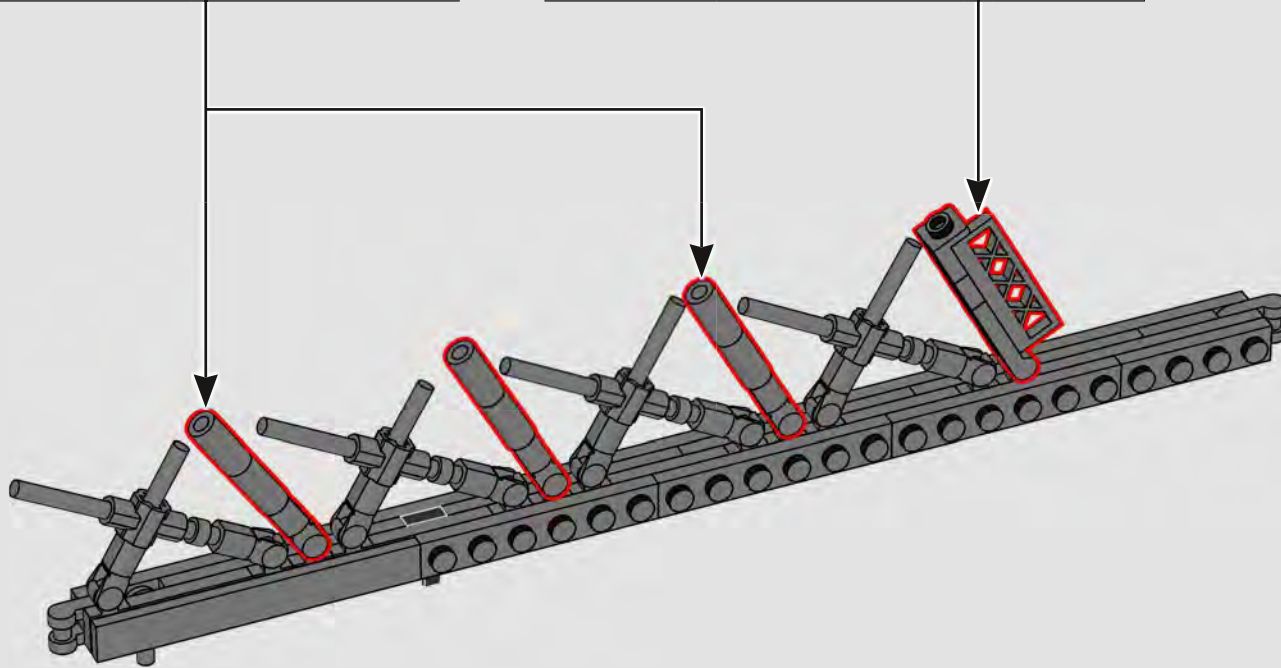
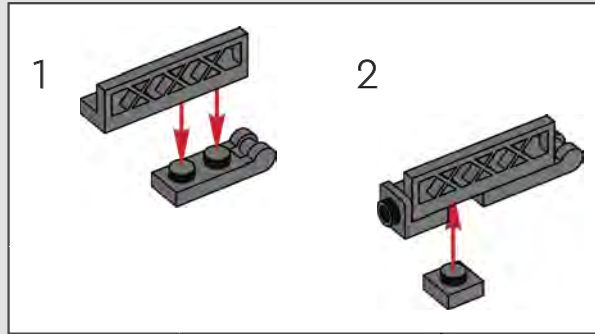
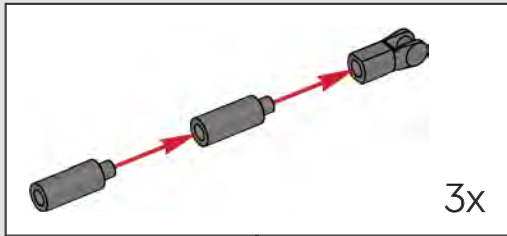

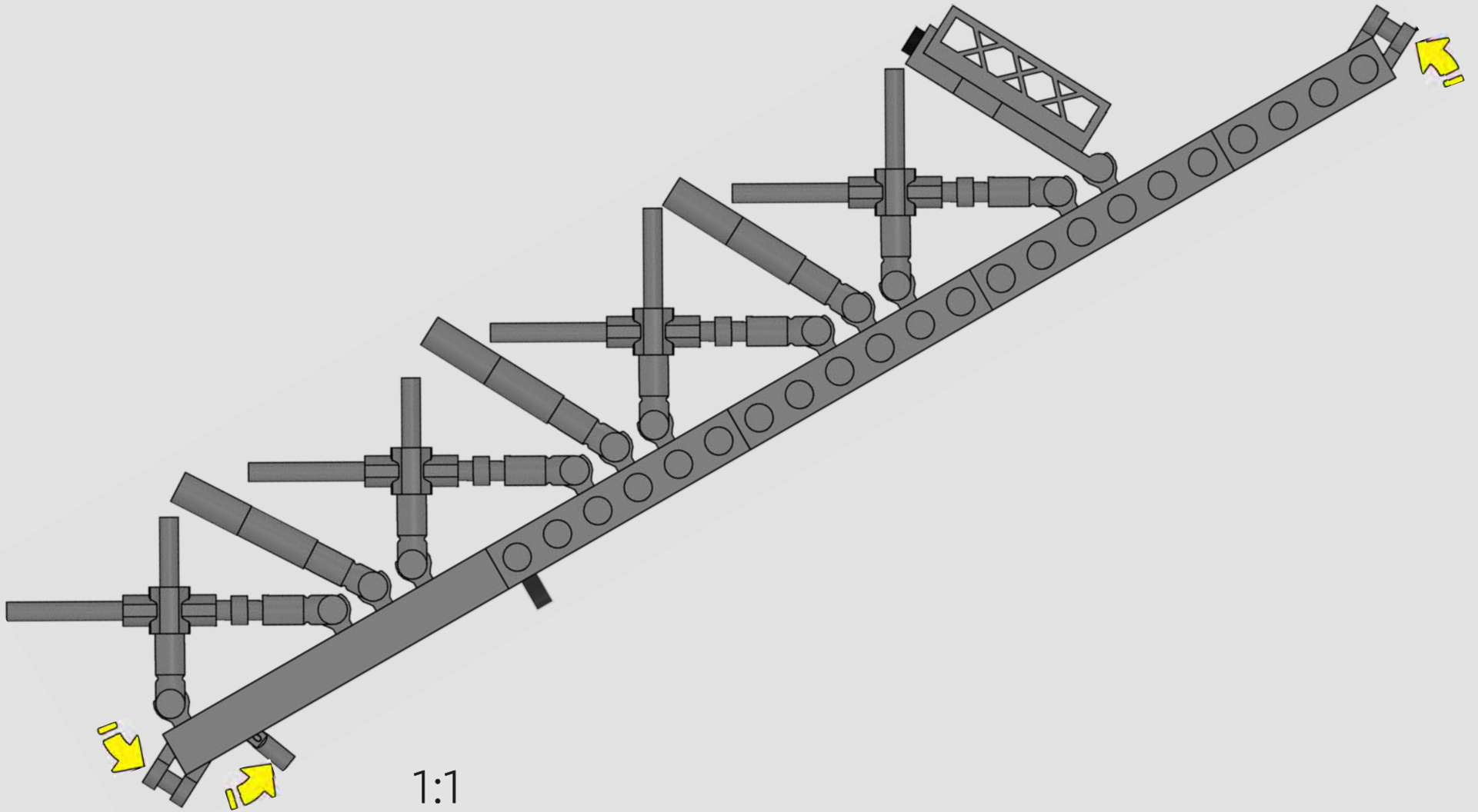

134

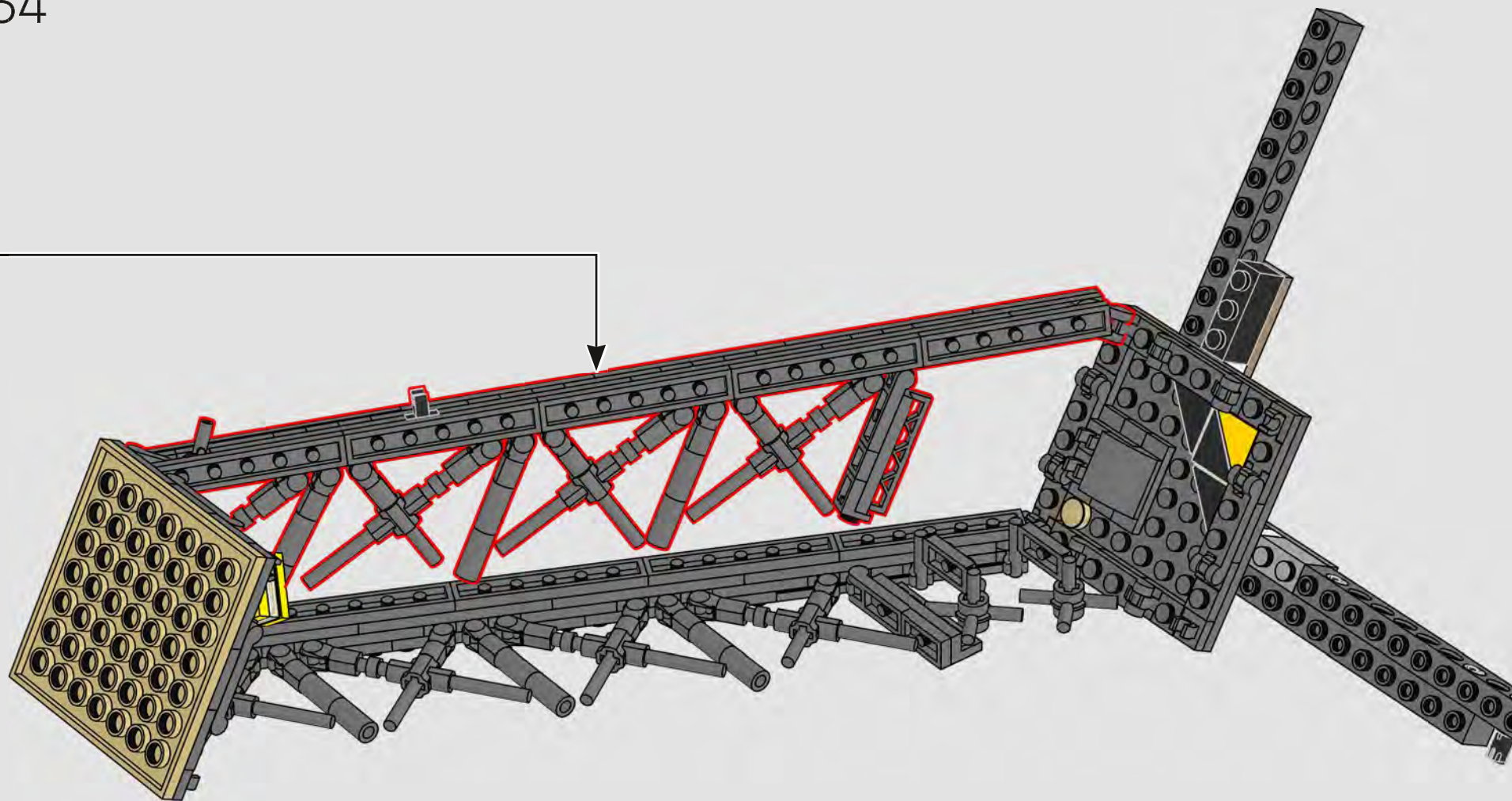

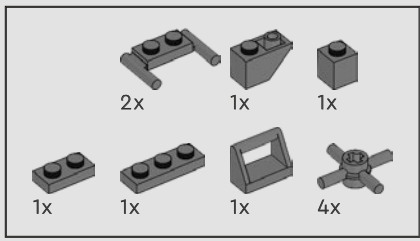

135

1

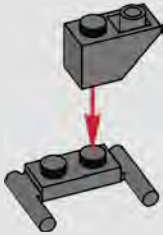

2

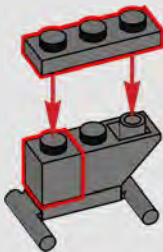

3

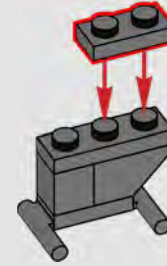

4

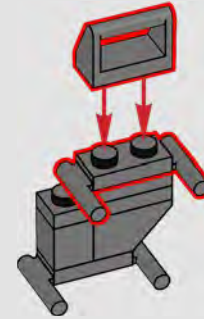

5

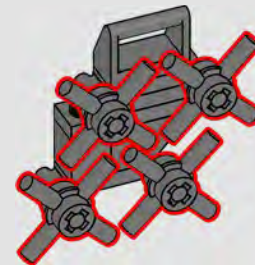

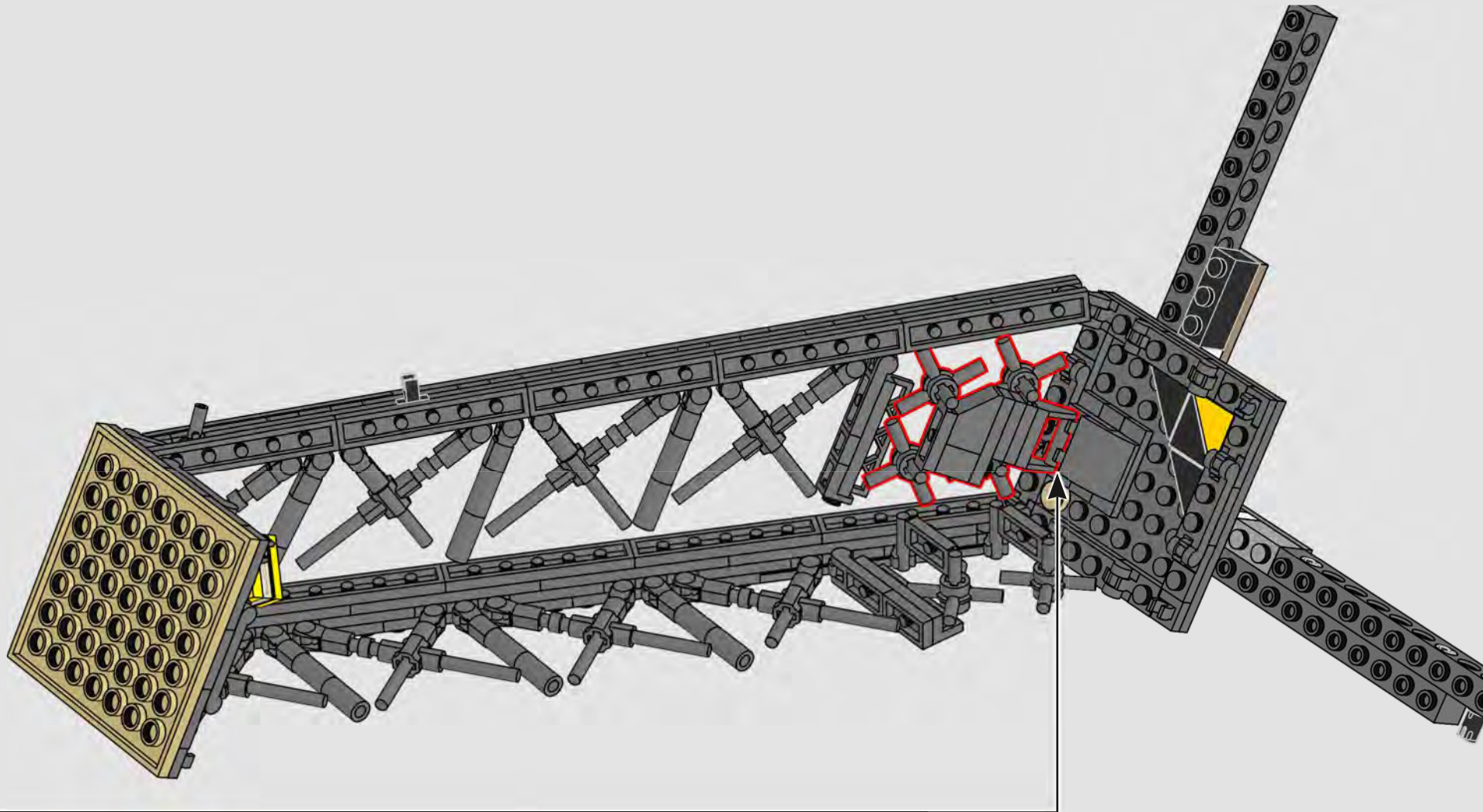

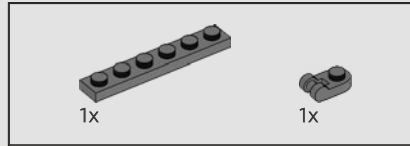
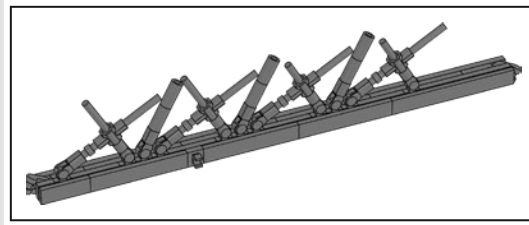

136

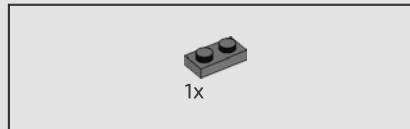
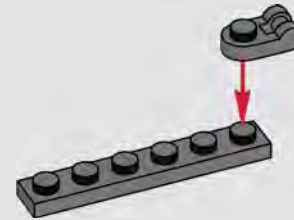

137

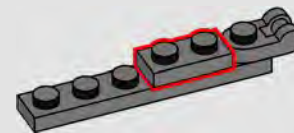

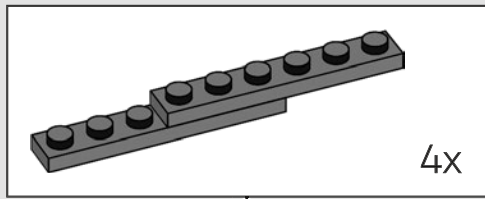
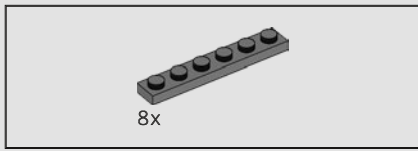

138

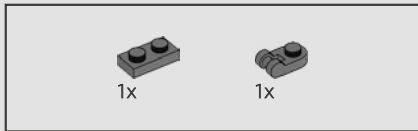
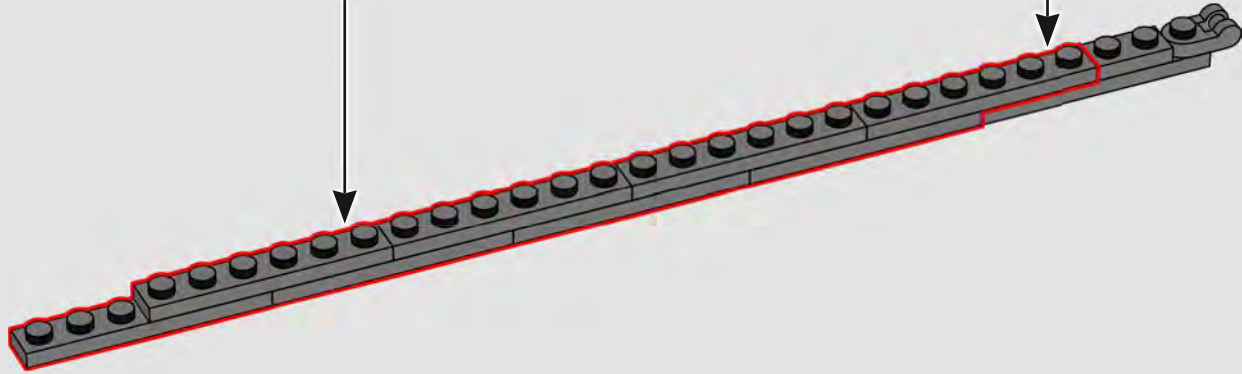

139

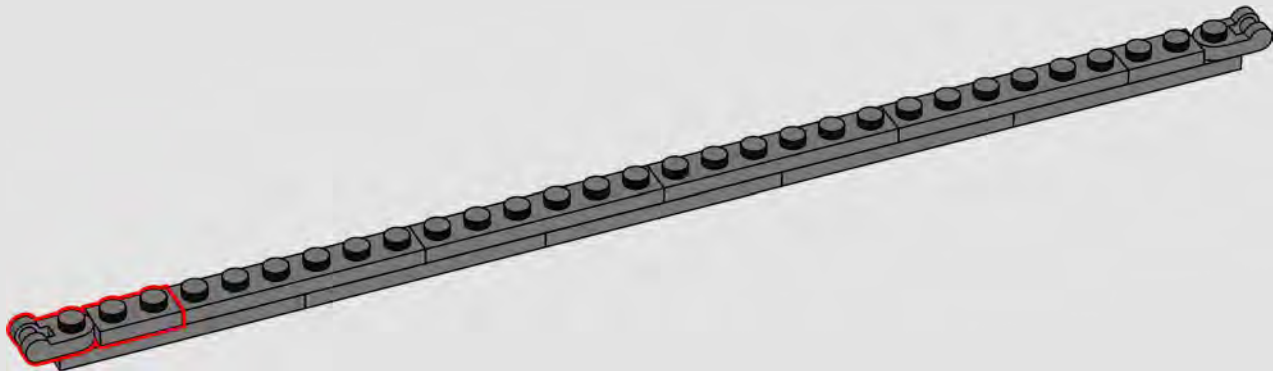

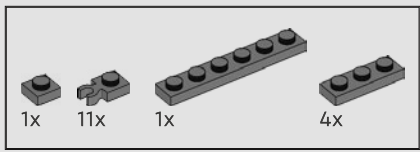

140

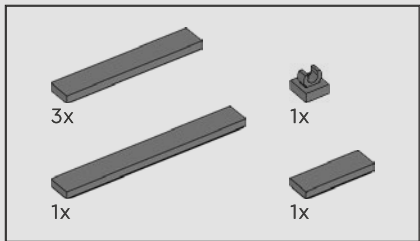
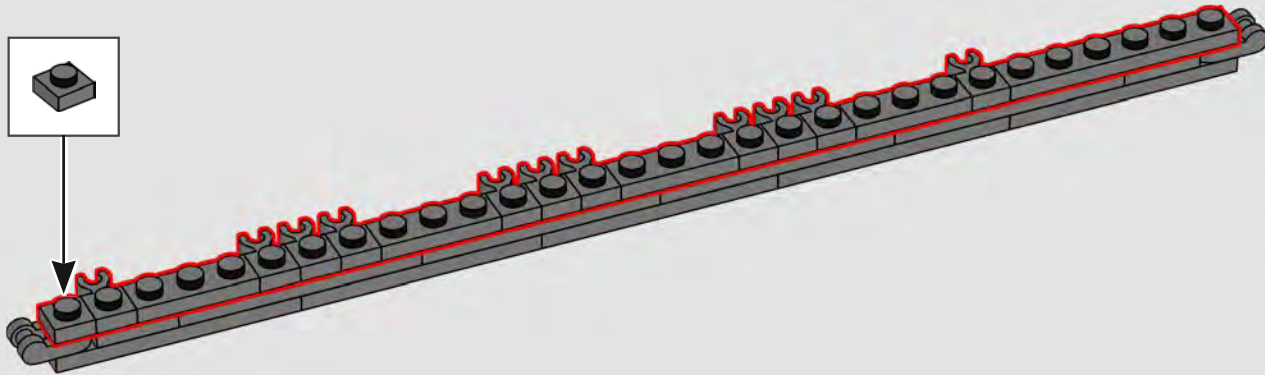

141

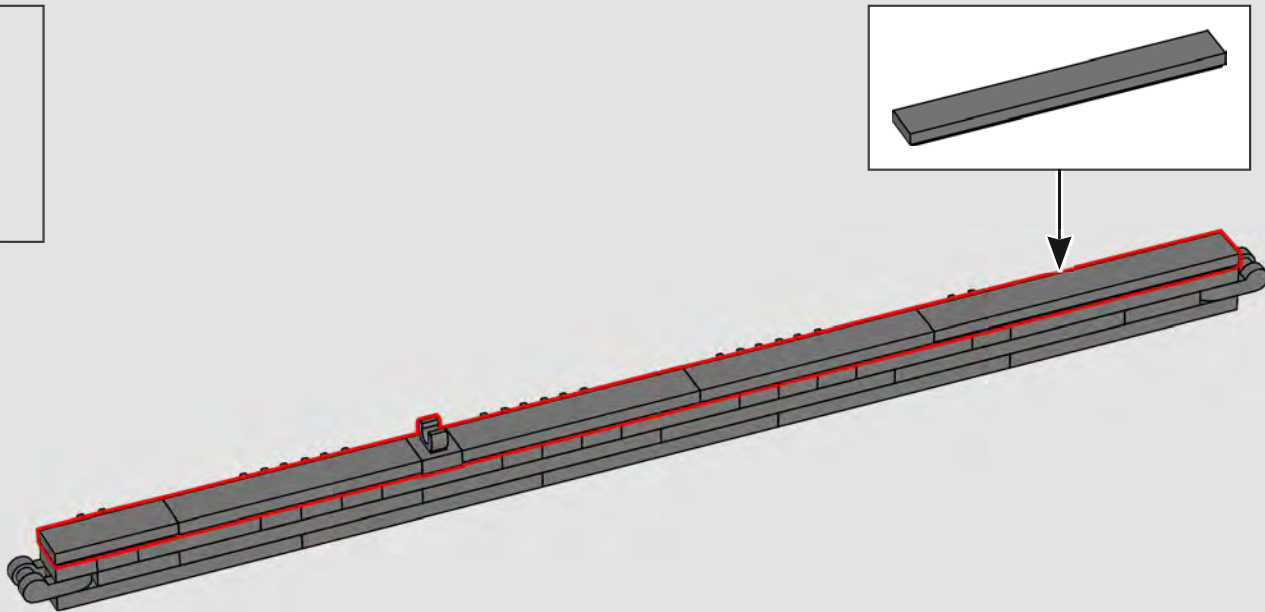

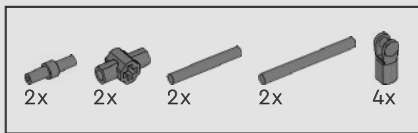

142

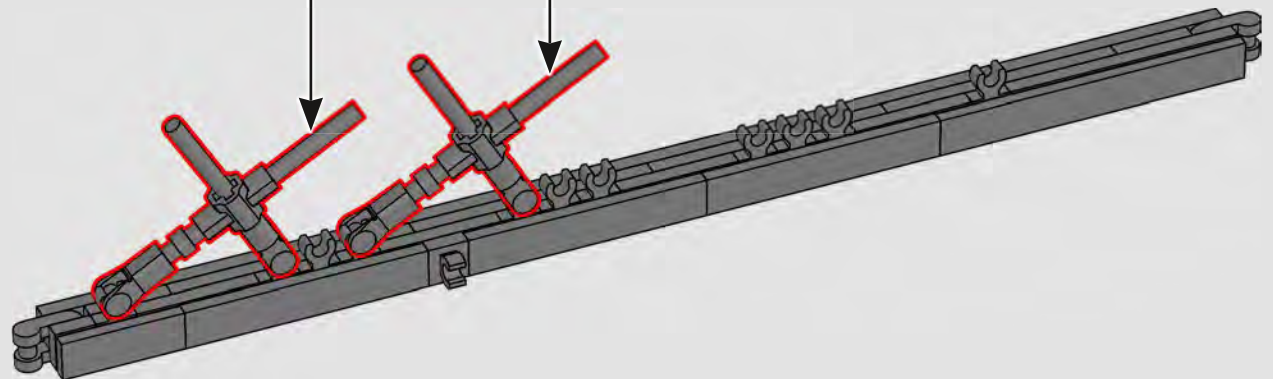
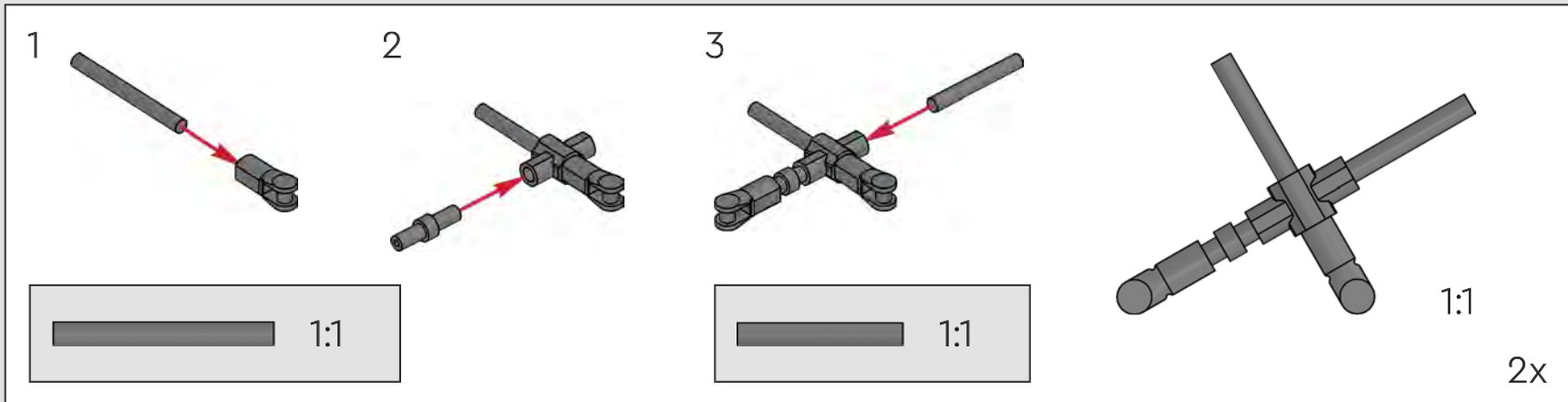

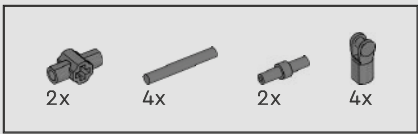

143

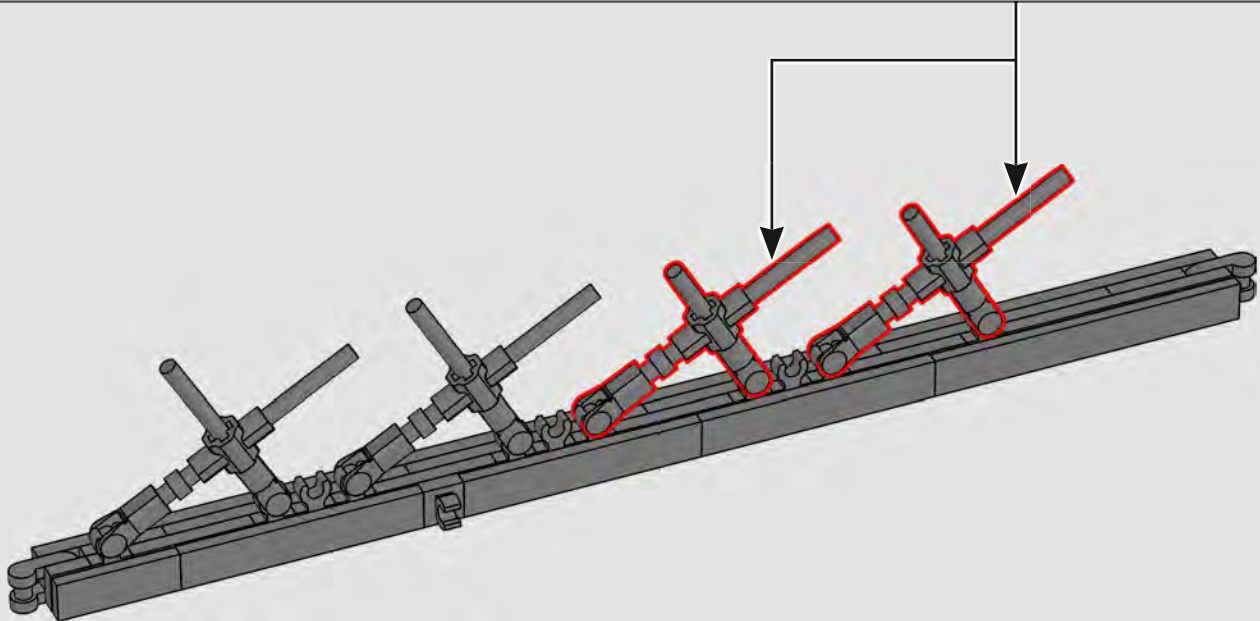
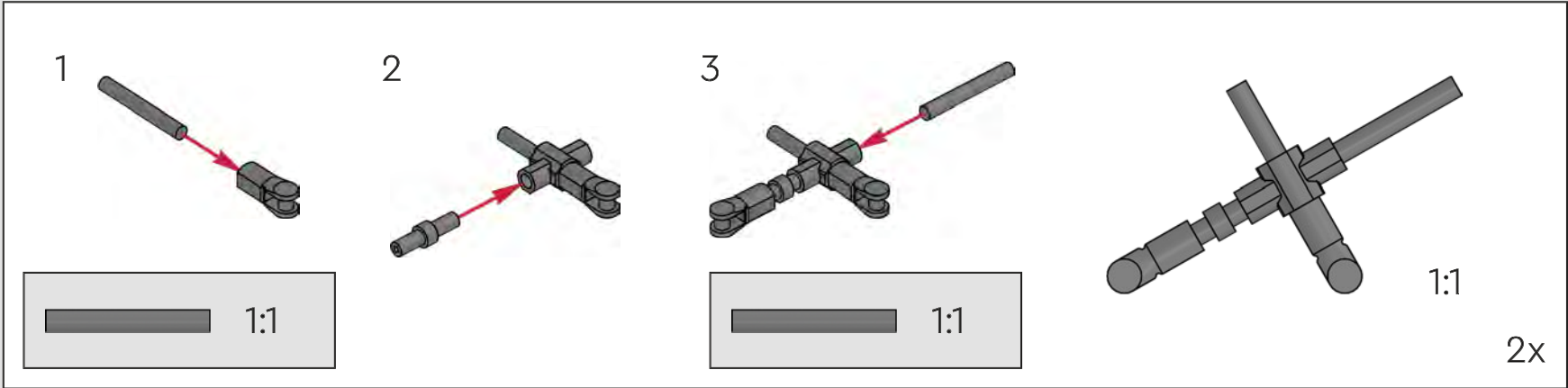

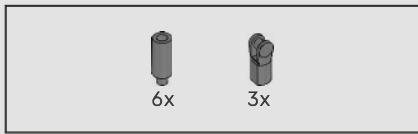

144

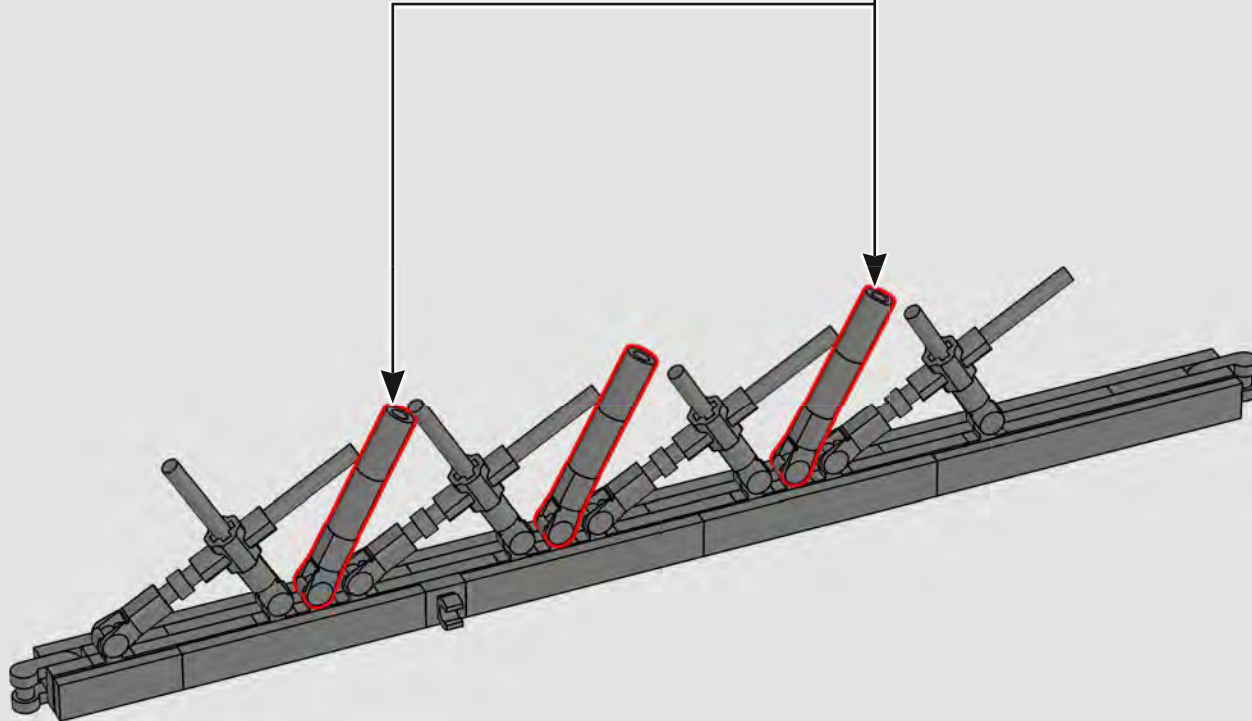
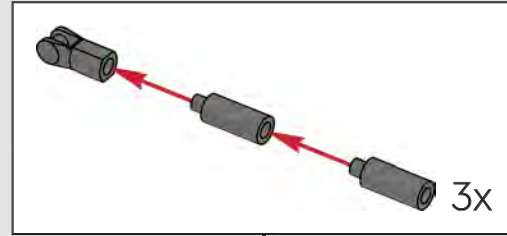

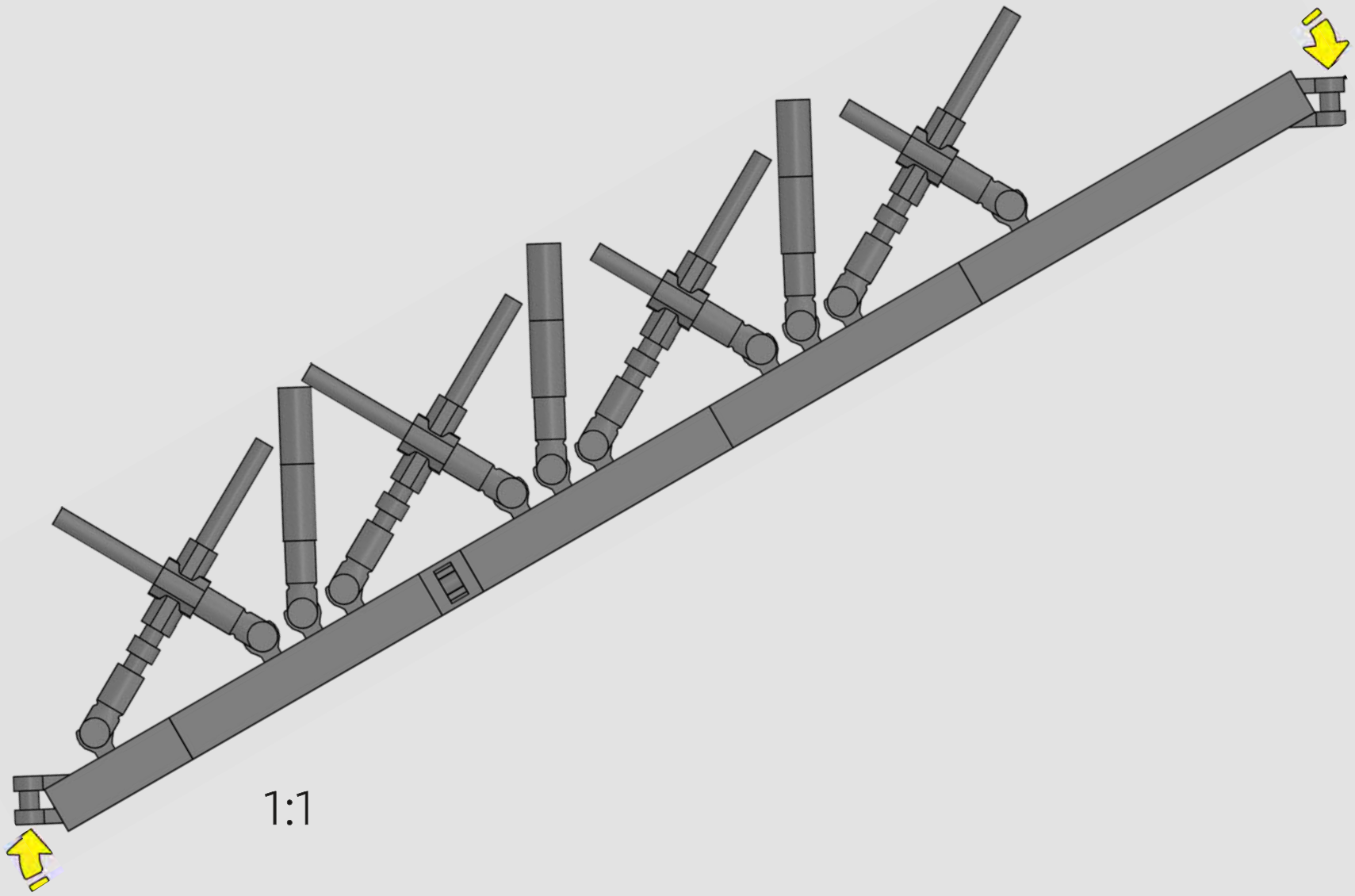

1:1

145

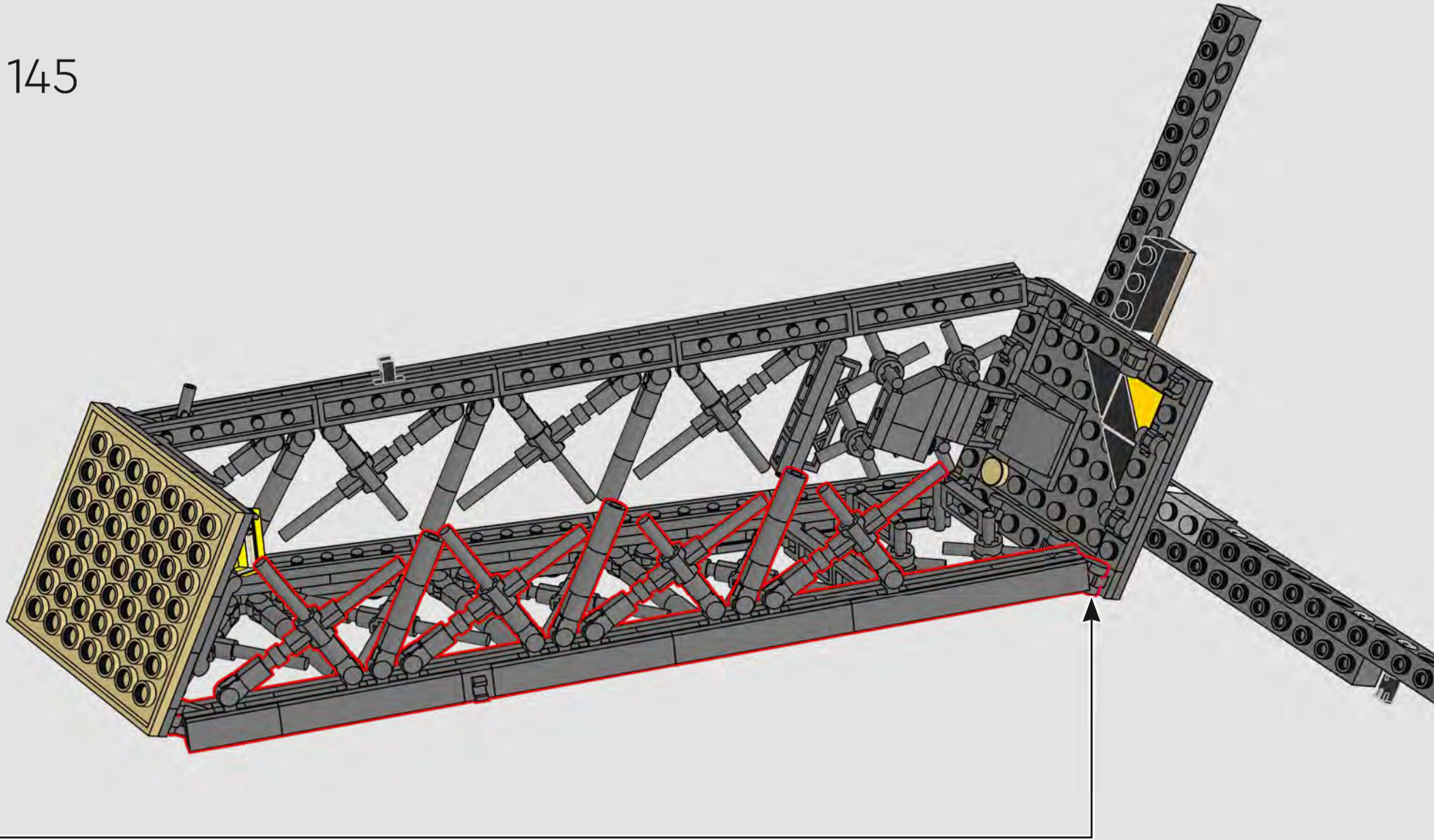

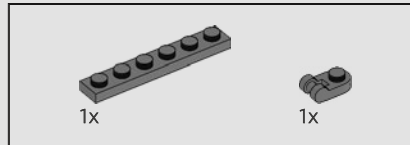
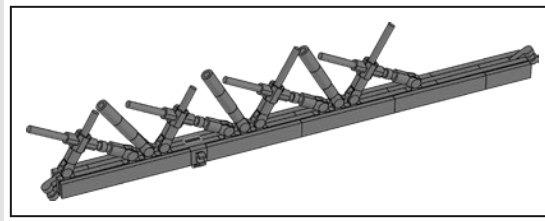

146

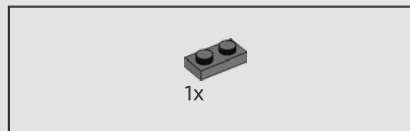
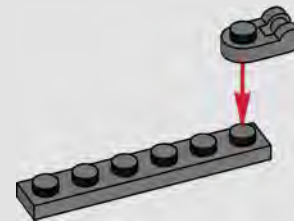

147

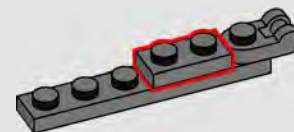

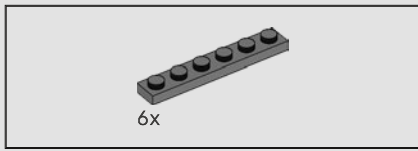

148

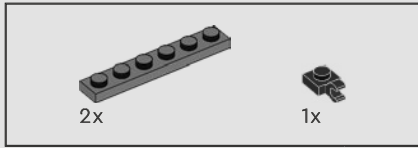
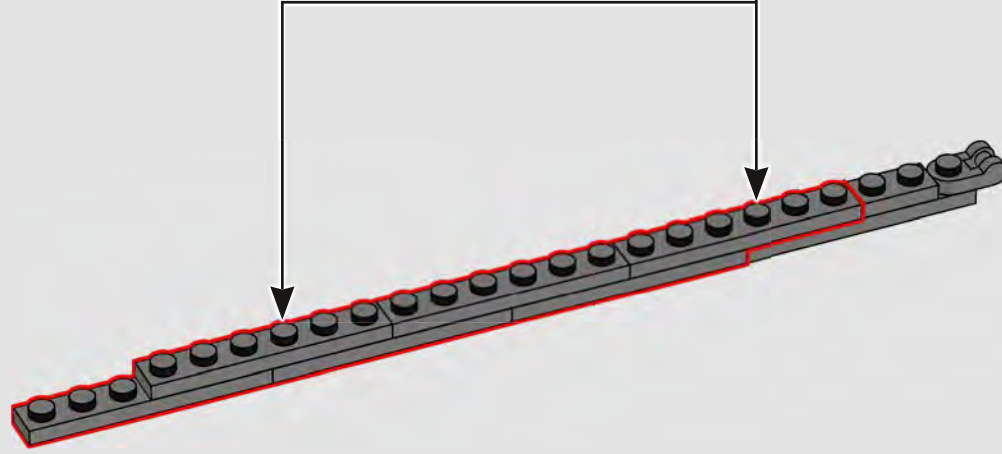
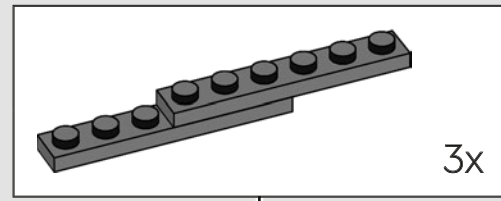

149

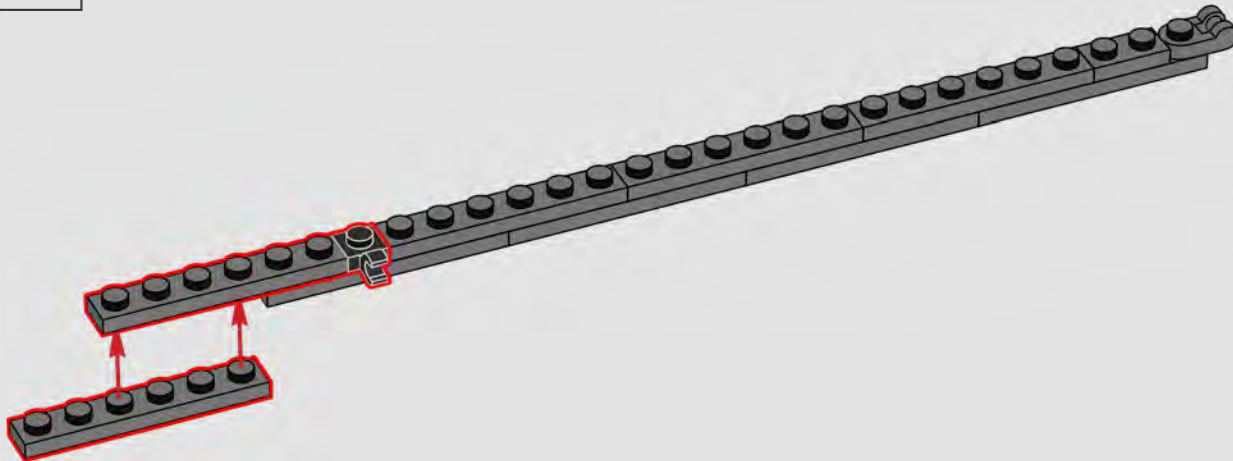

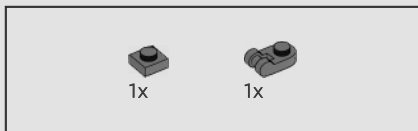

150

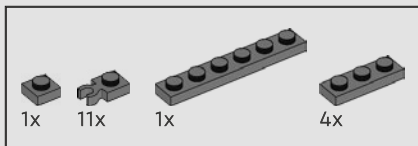
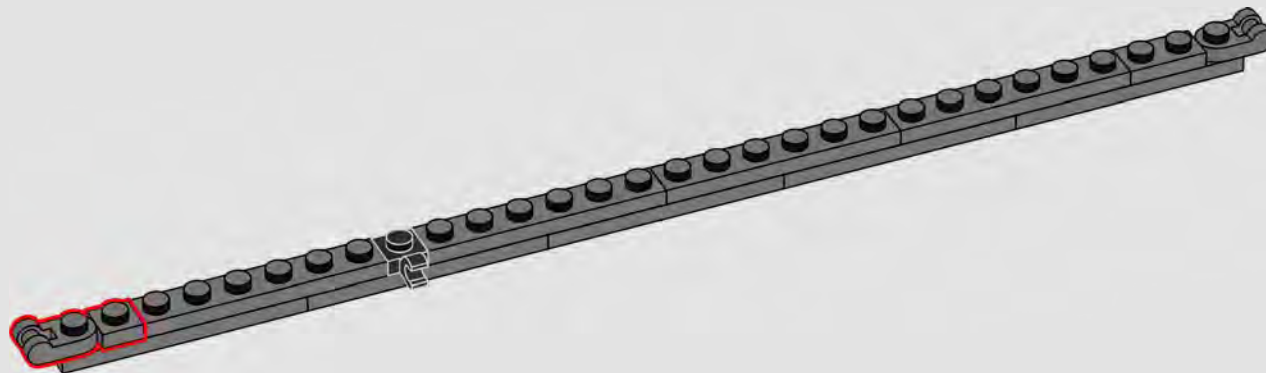

151

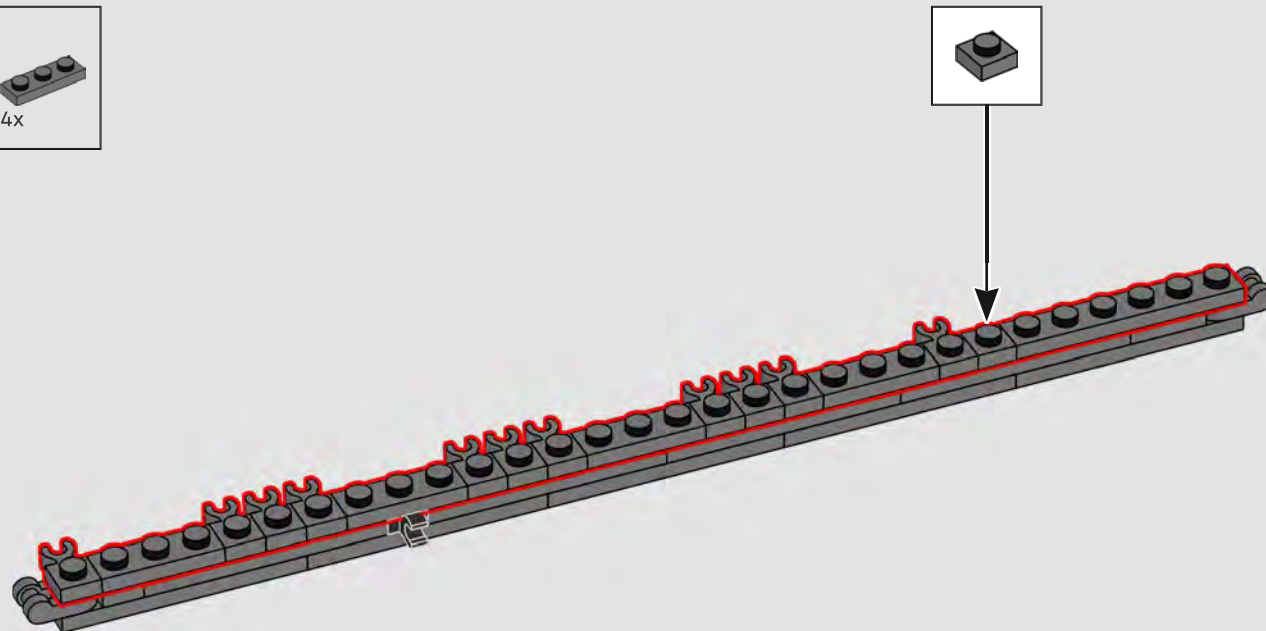

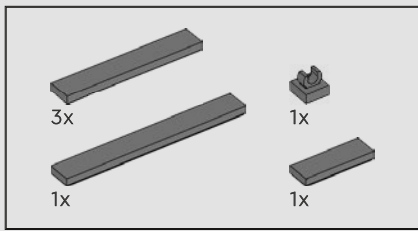

152

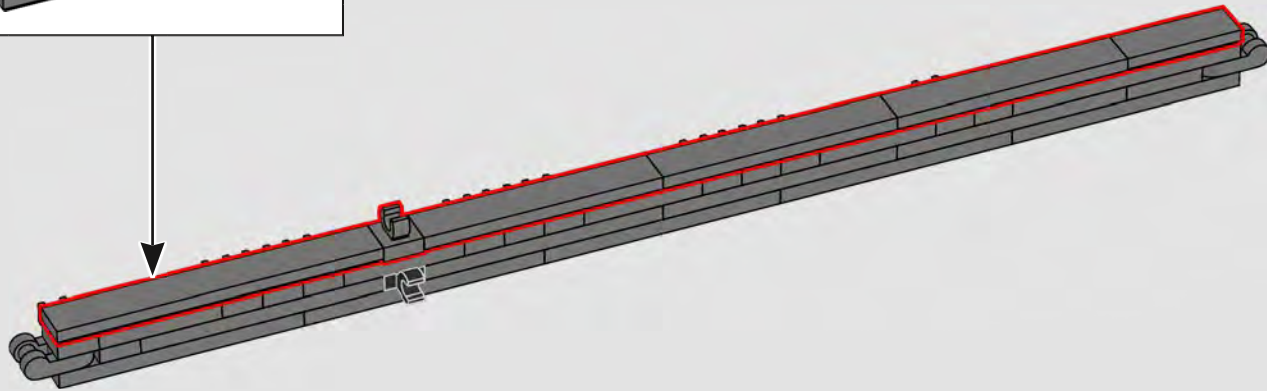
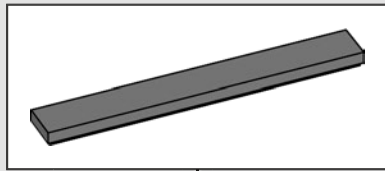

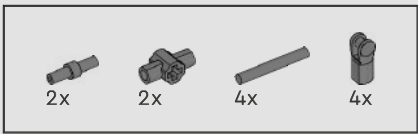

153

1 2 3

1:1 1:1 1:1 2x

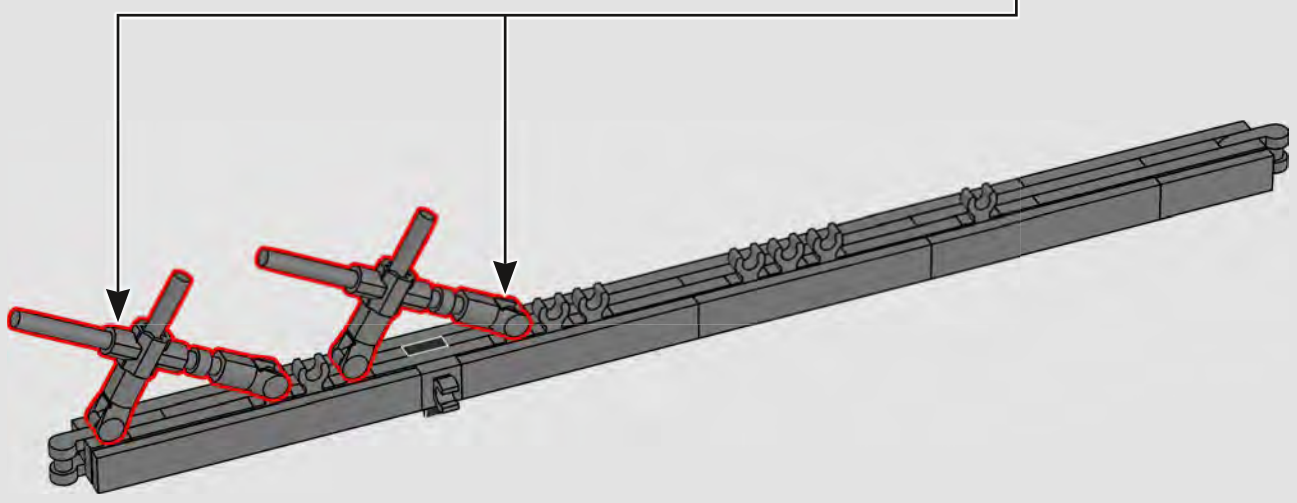

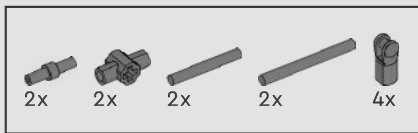

154

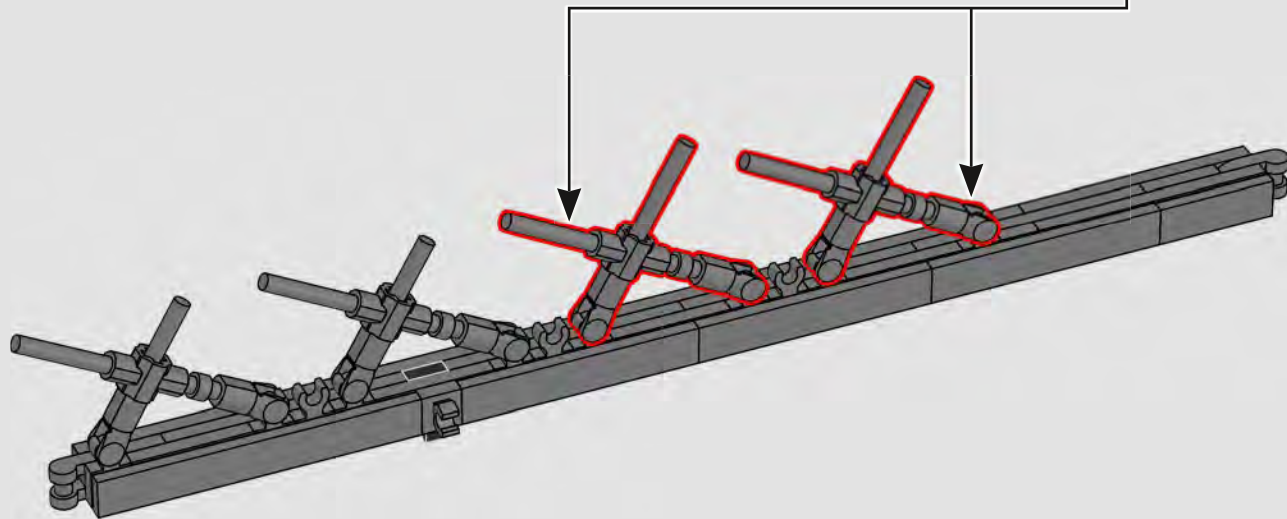
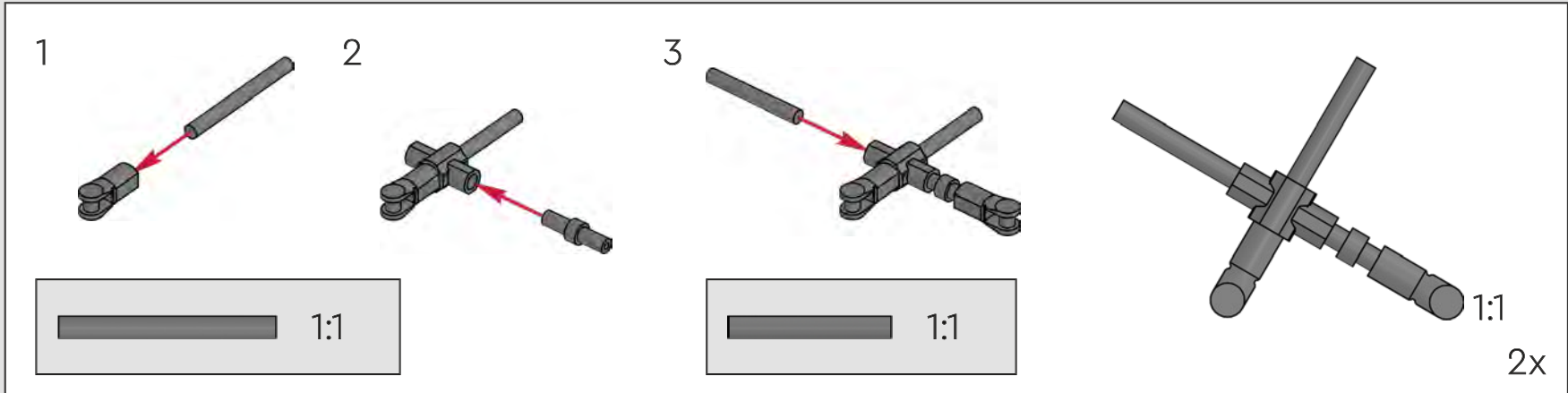

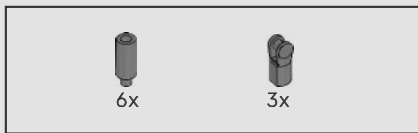

155

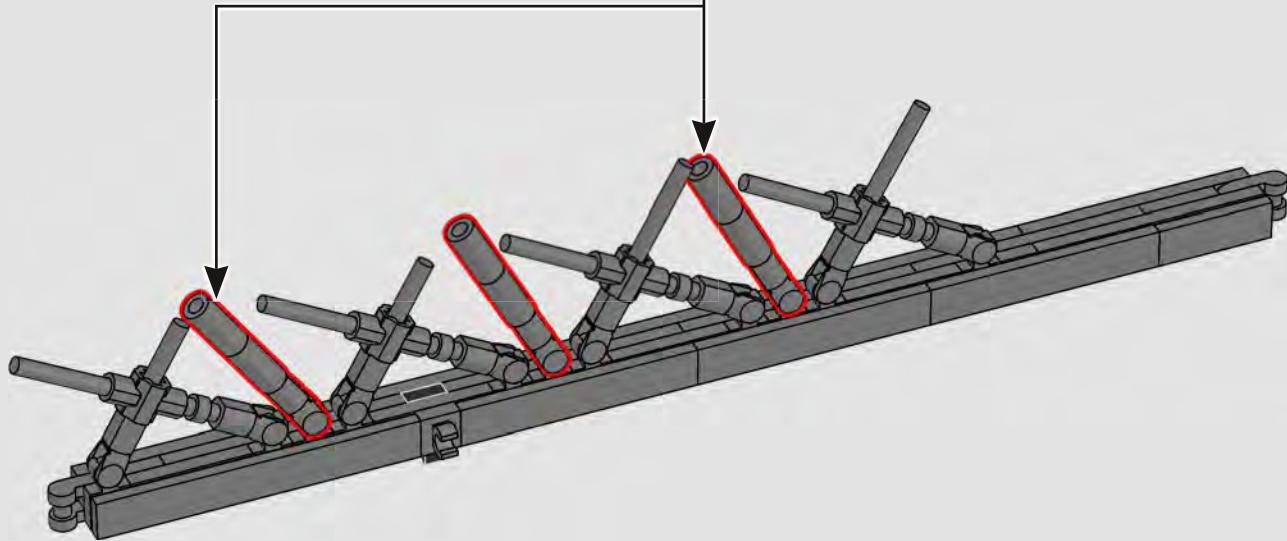
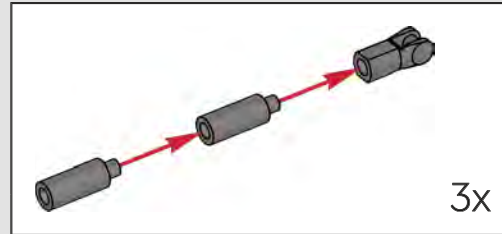

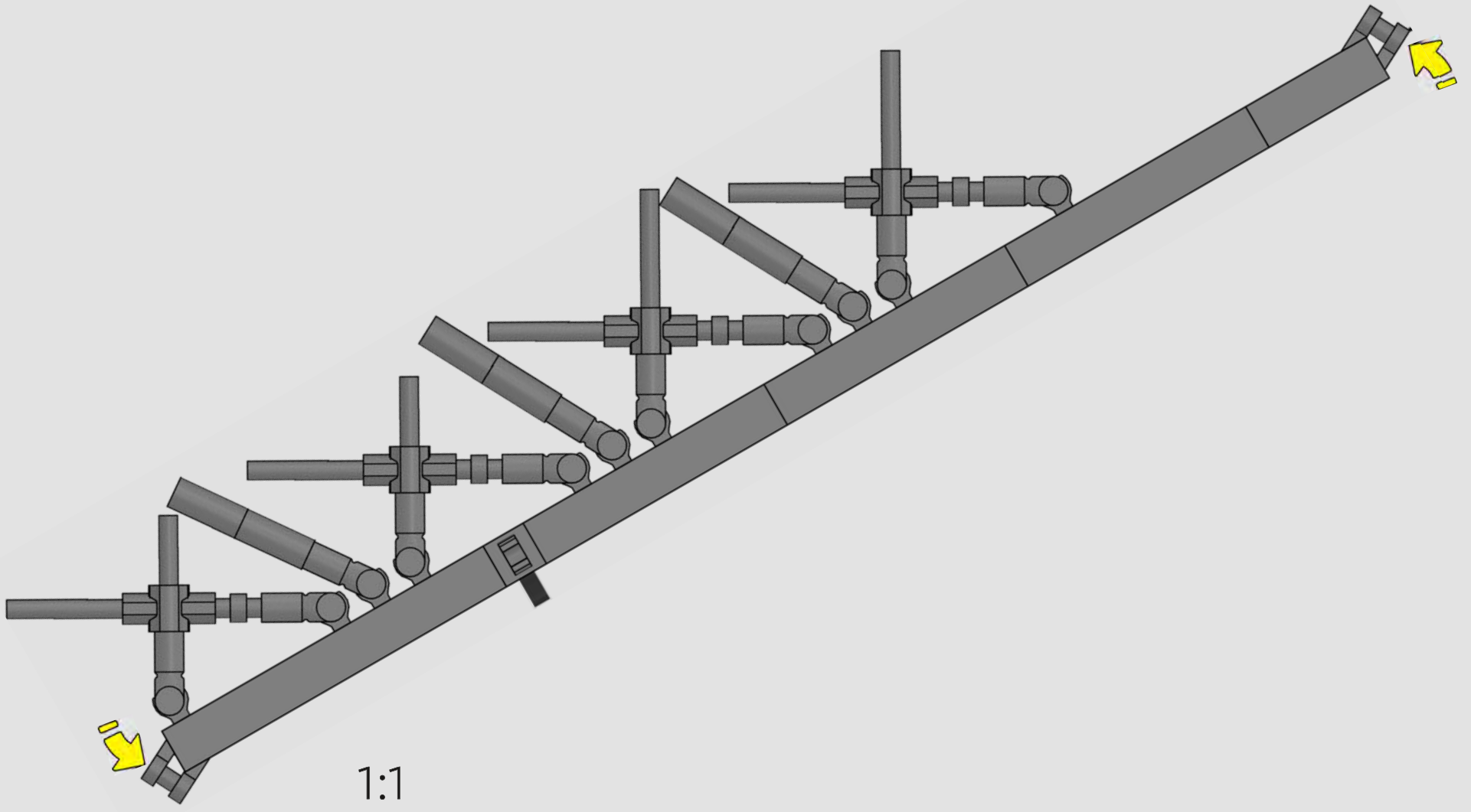

1:1

156

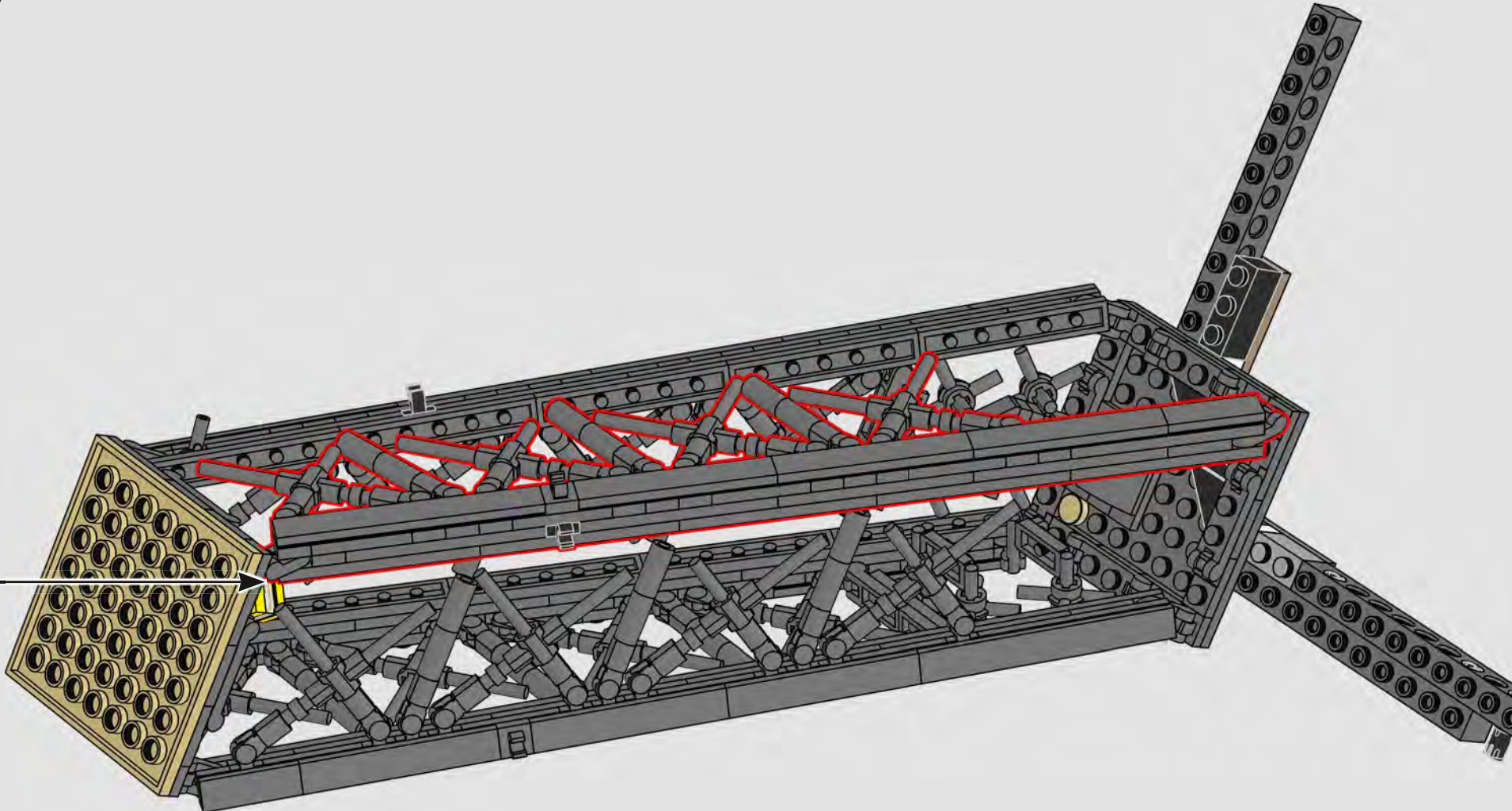

2x



The original tower is assembled from pre-made pieces, just like a giant LEGO® model! While the Eiffel tower contains 18,038 different pieces, this LEGO version has 10,0001 individual LEGO elements.

157



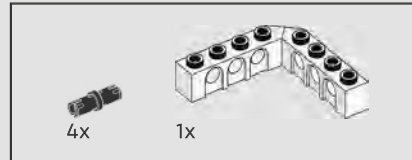
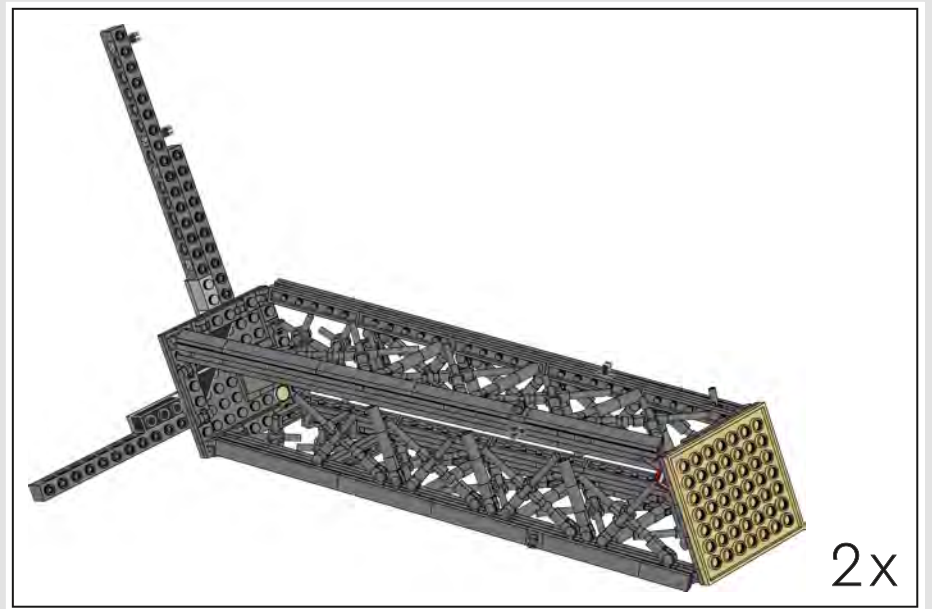

158

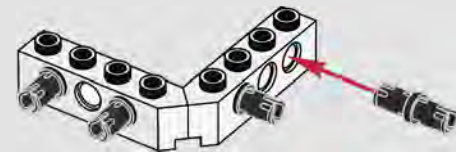

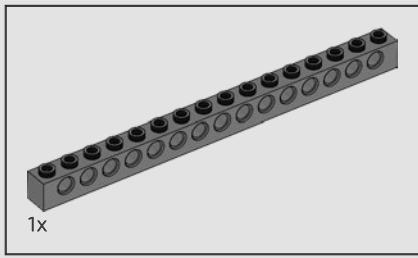

159

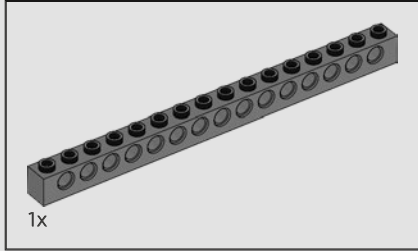
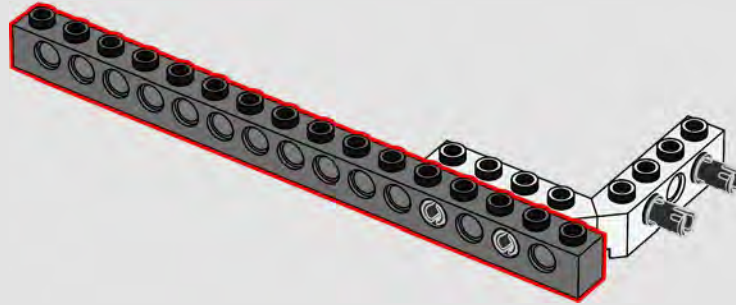

160

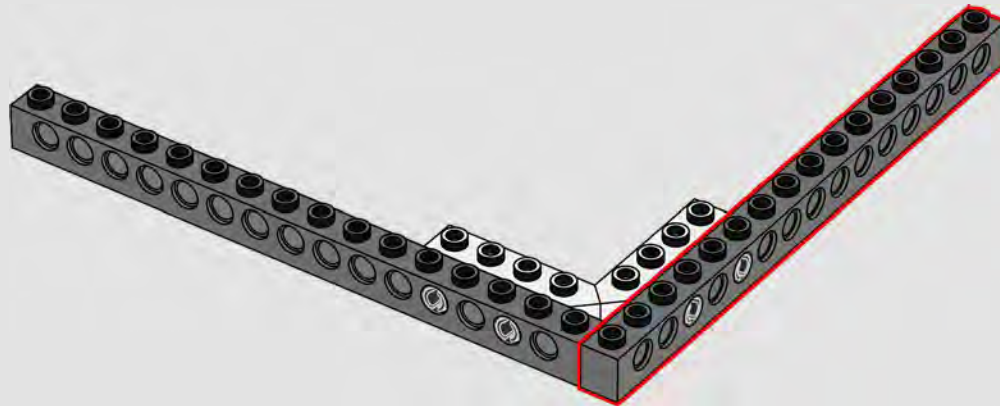

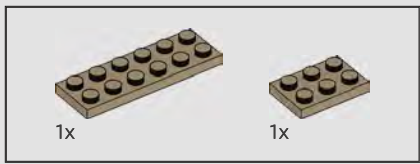

161

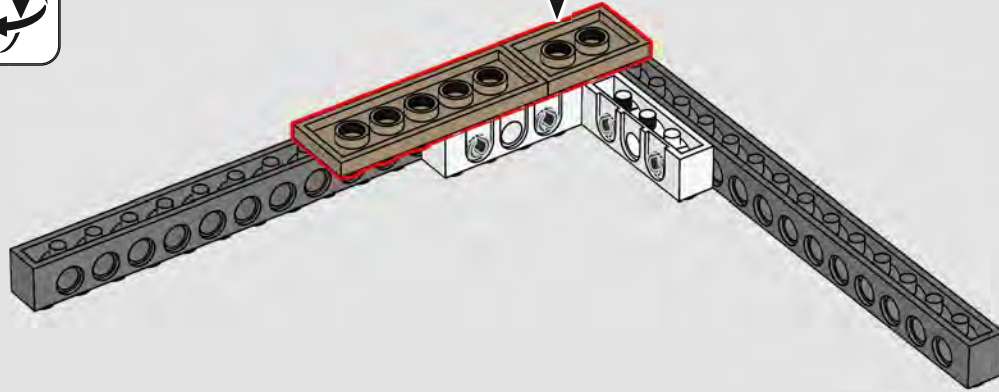
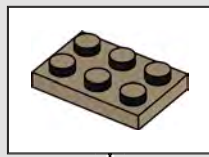

162

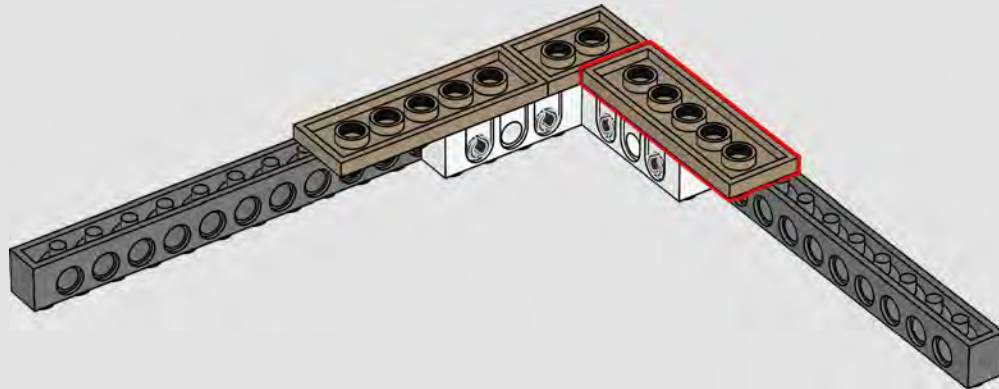

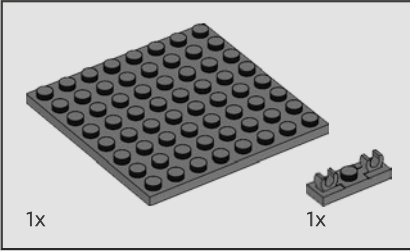

163

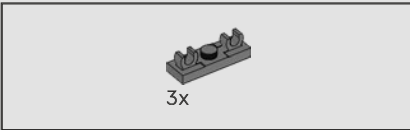
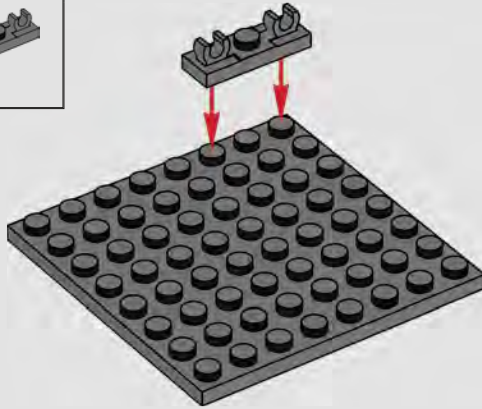

164

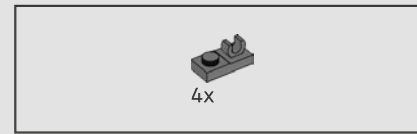
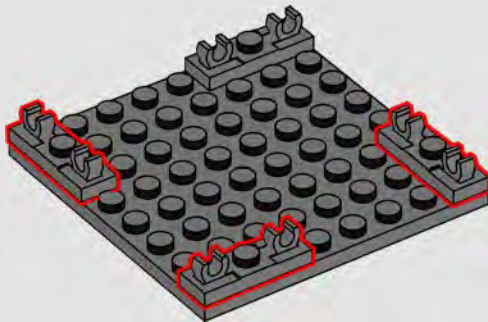

165

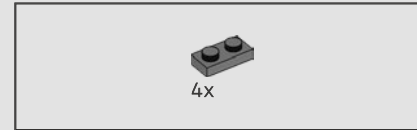
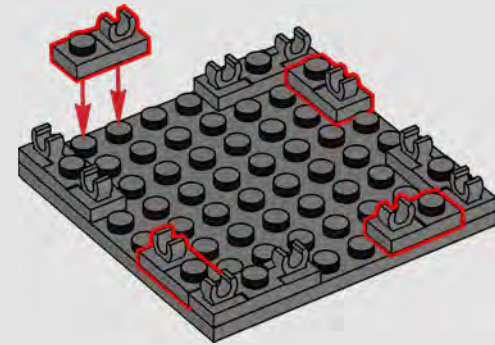

166

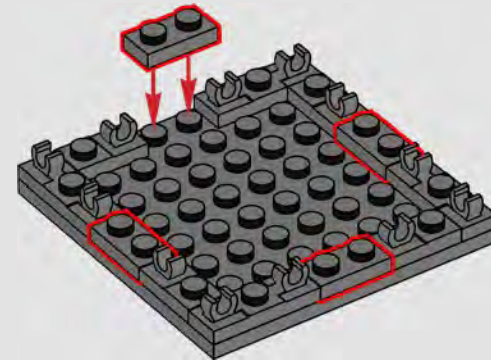

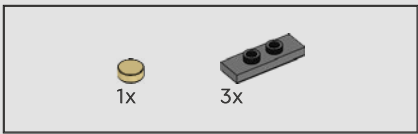

167

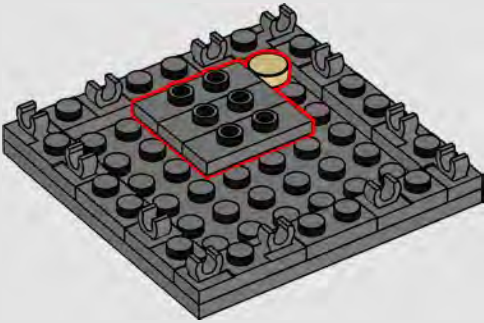

168

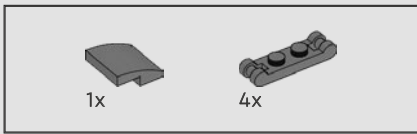
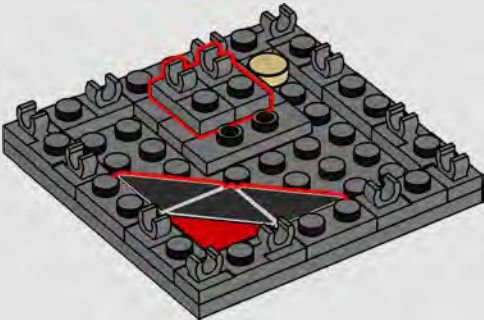

169

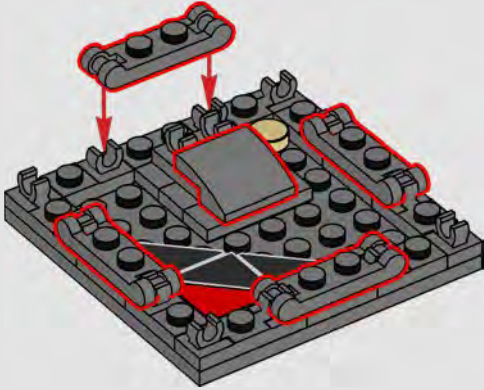

170

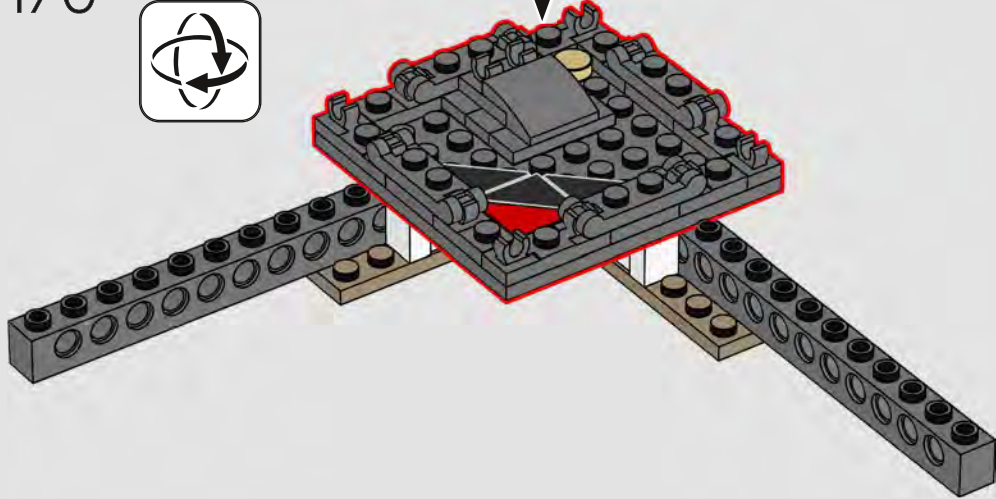

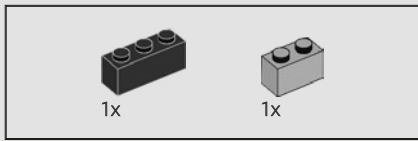

171

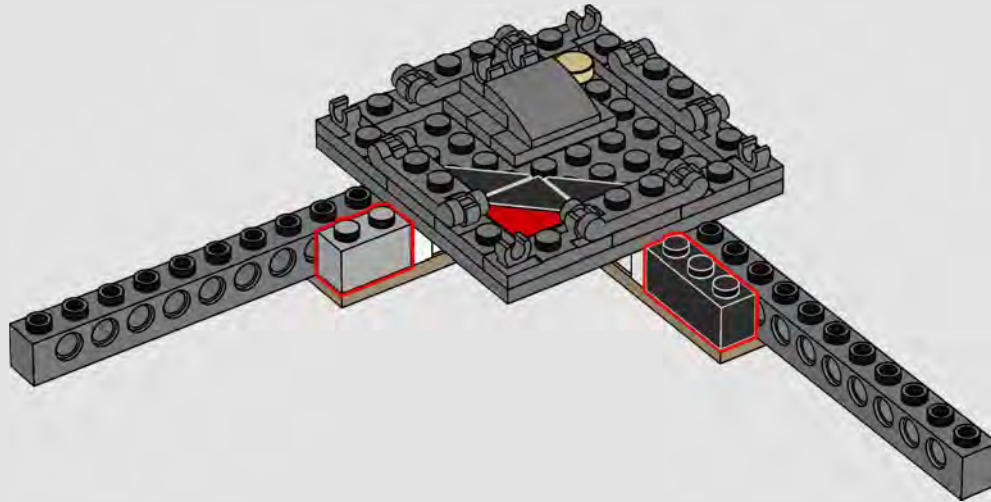

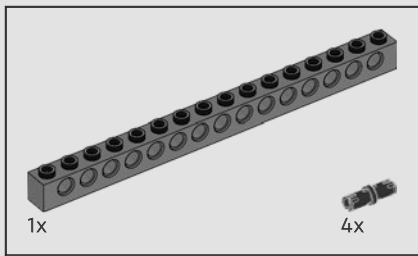

172

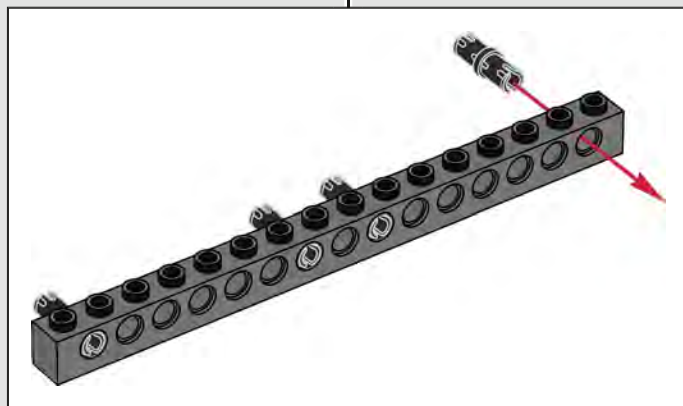
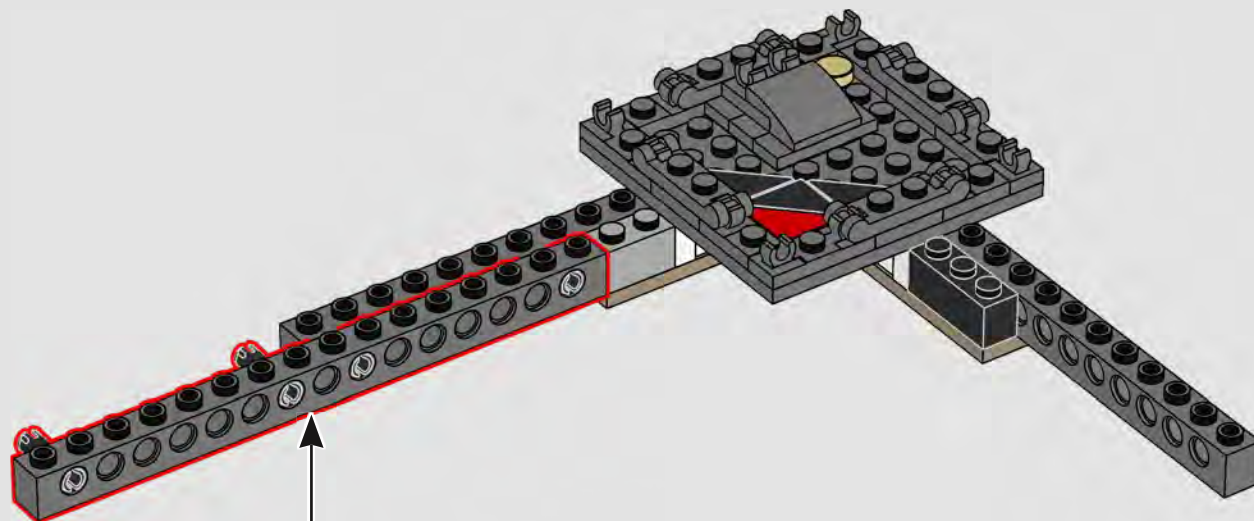

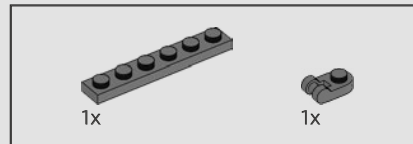
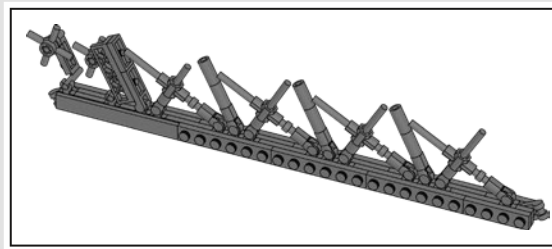

173

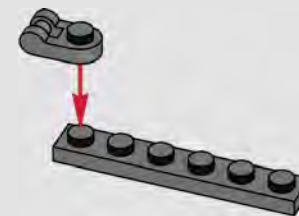

174

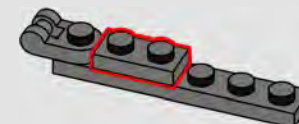

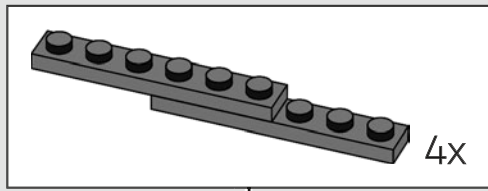
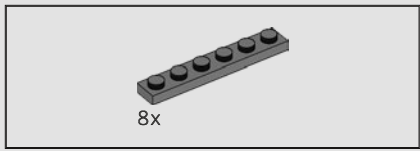

175

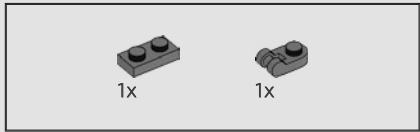
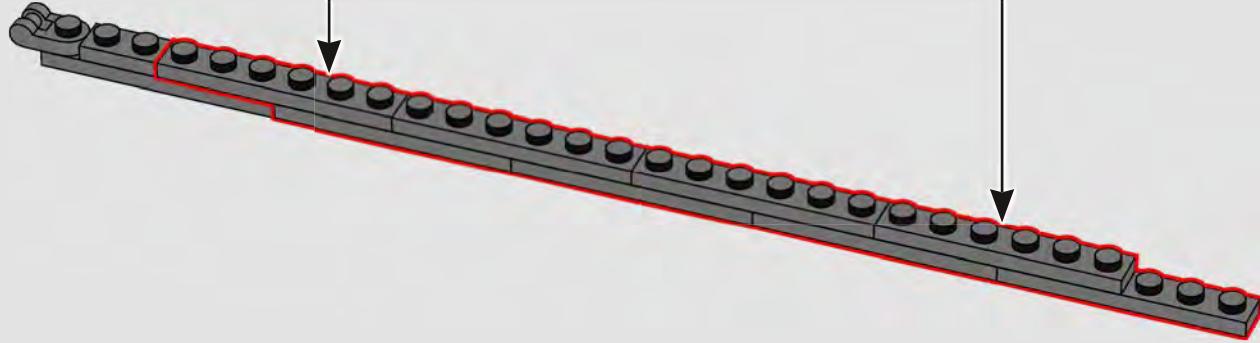

176

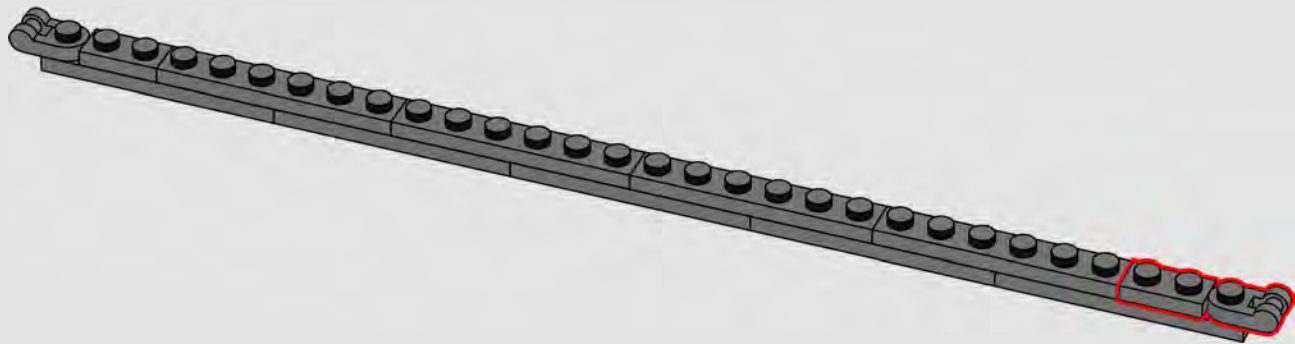

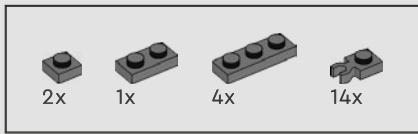

177

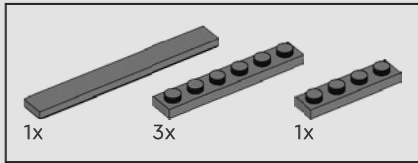
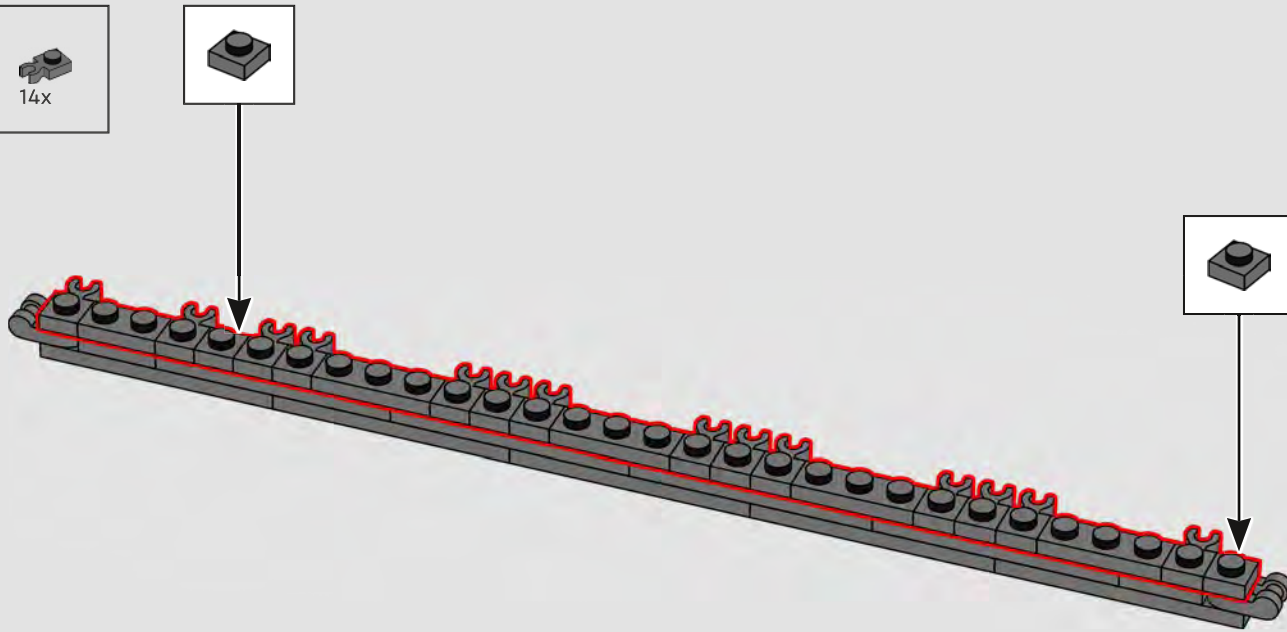

178

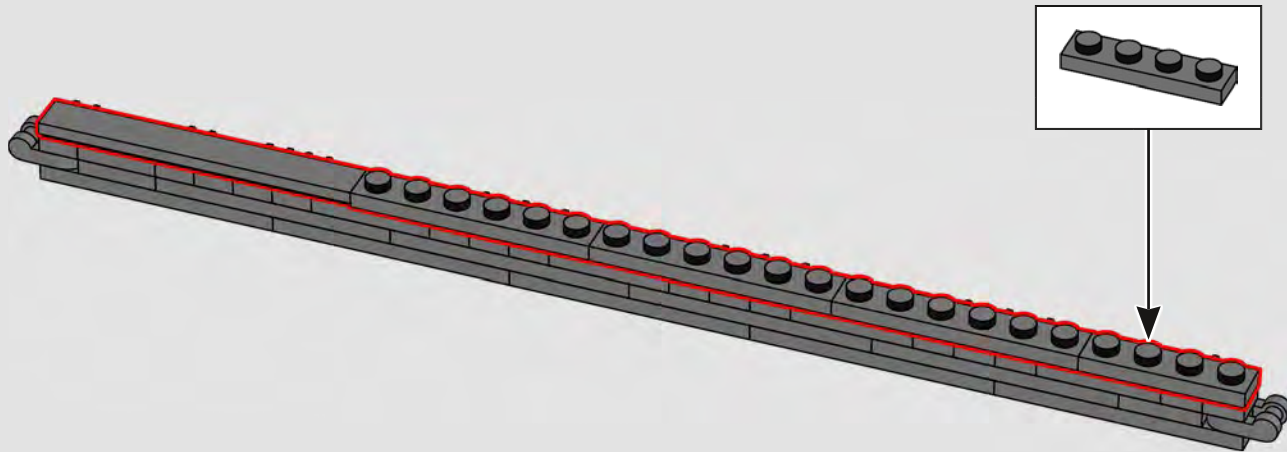

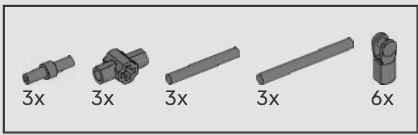

179

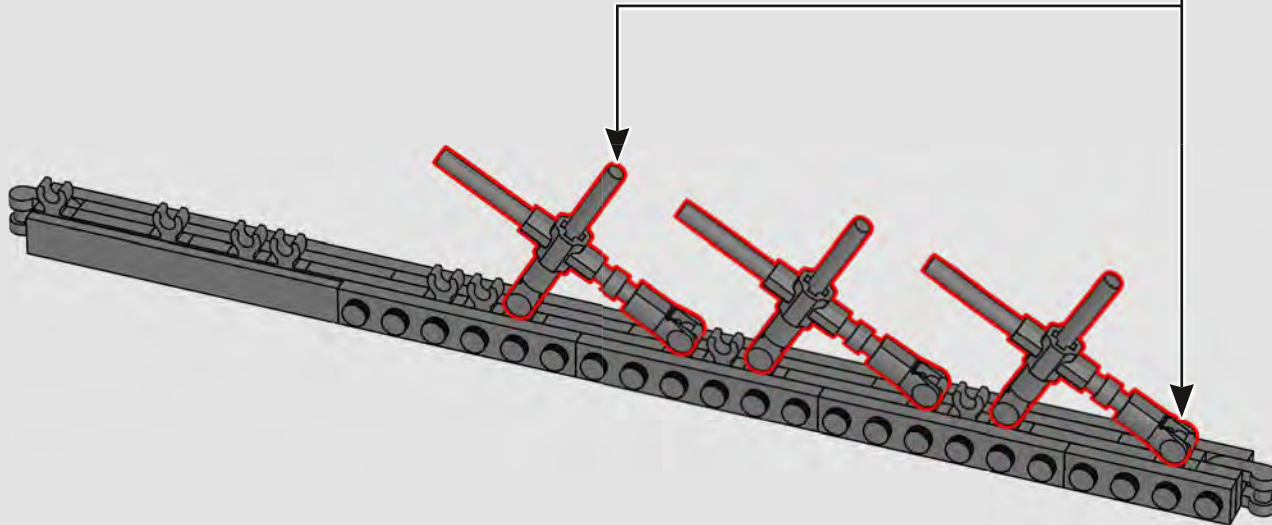
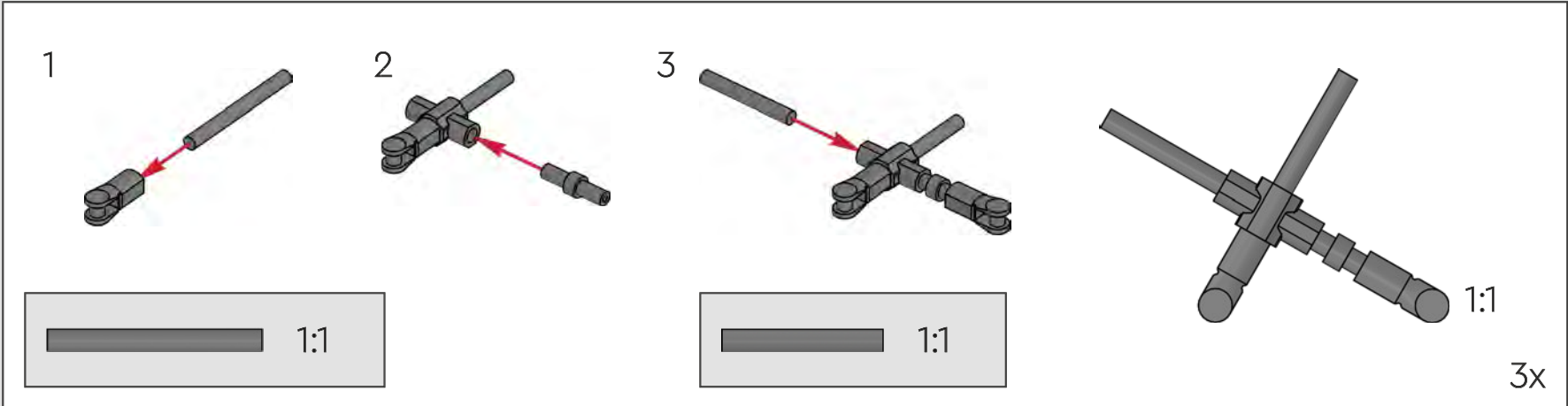



180

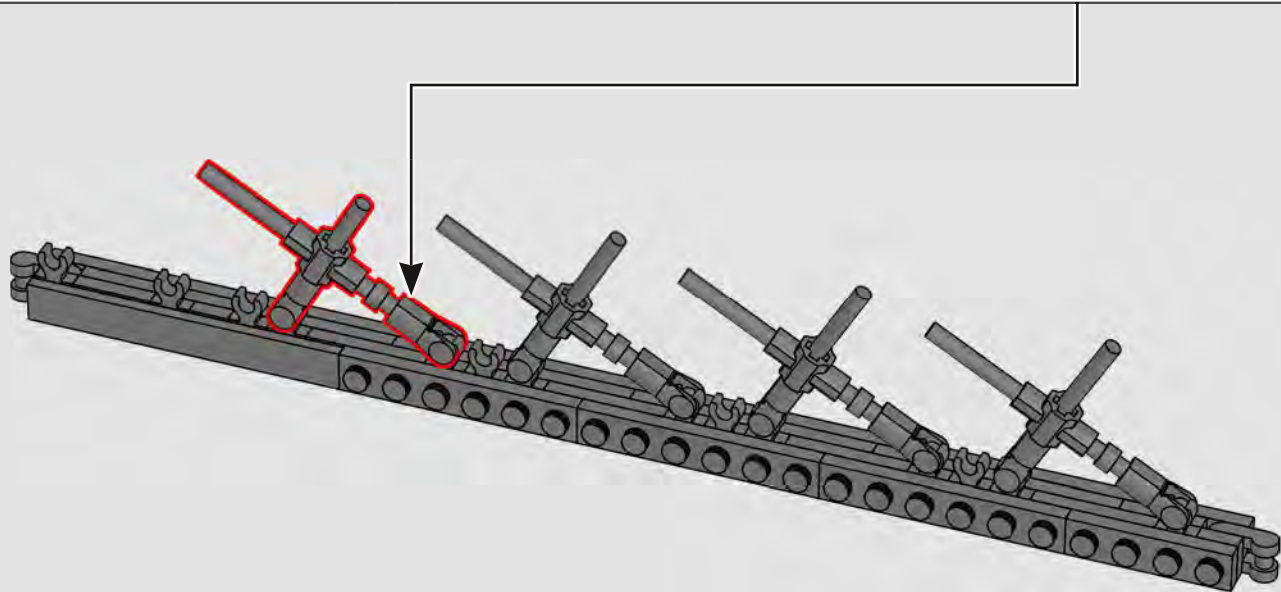
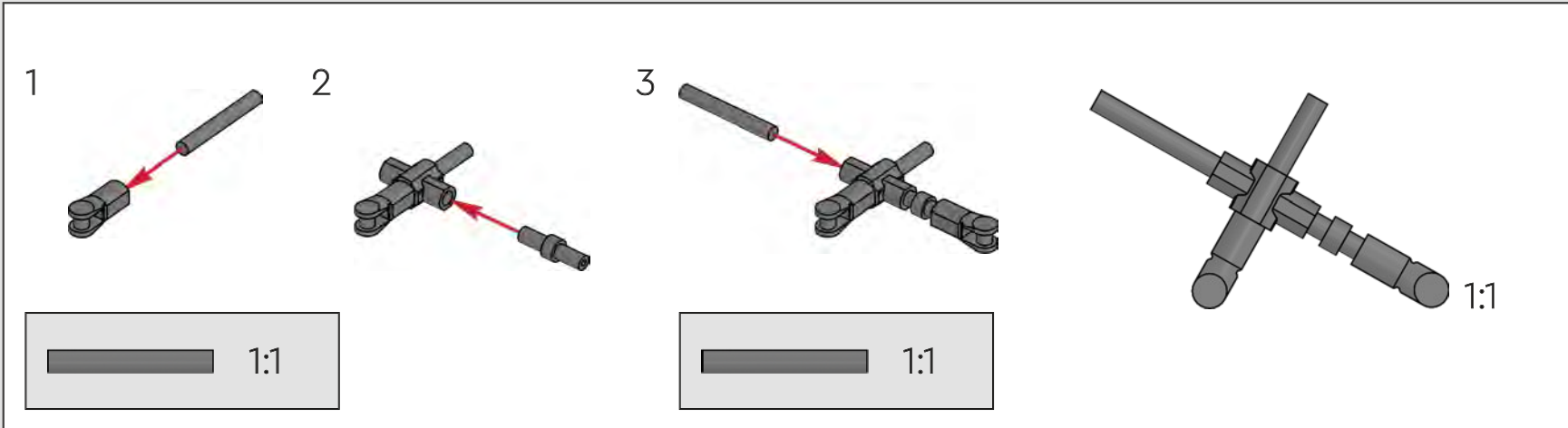

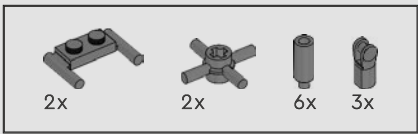

181

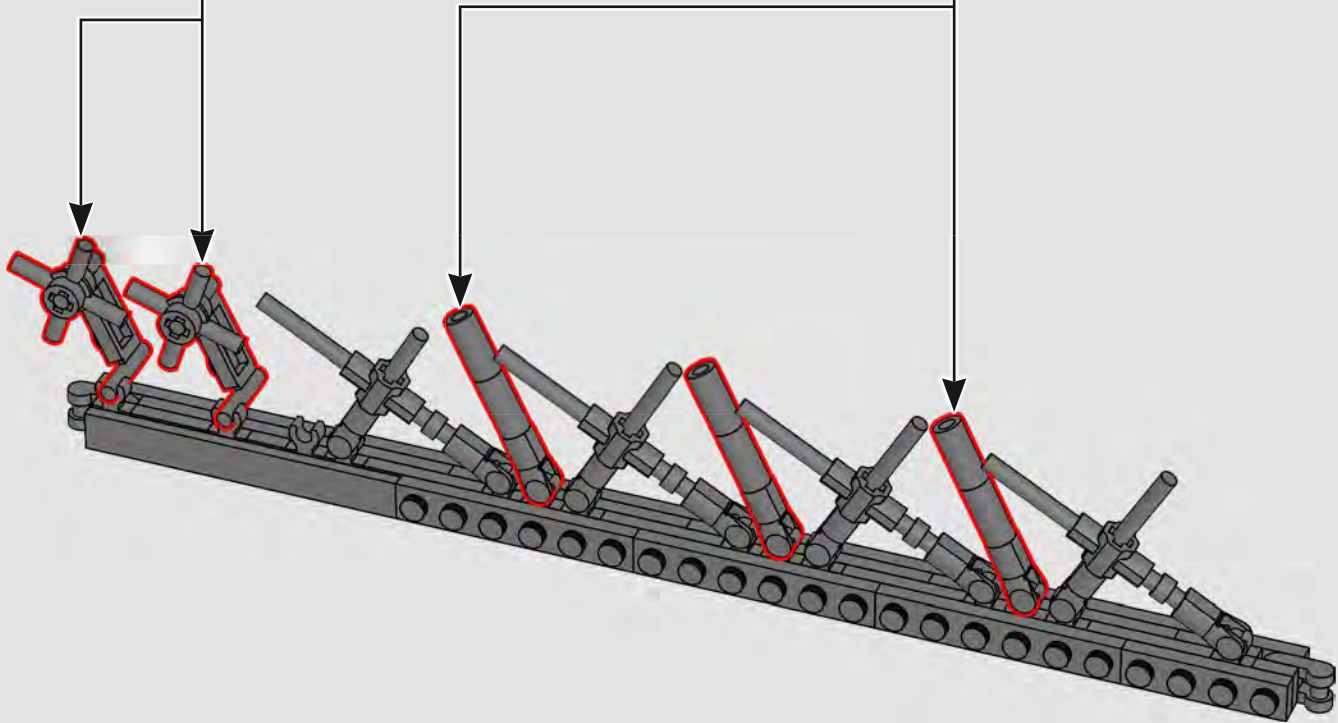
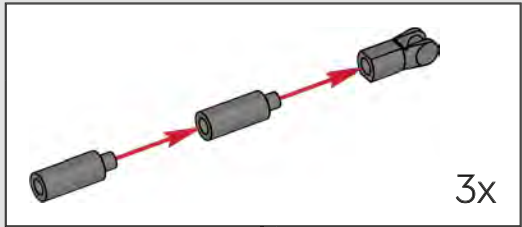
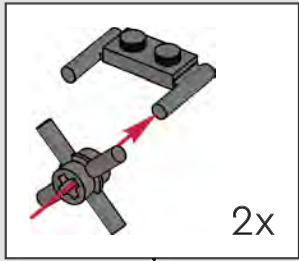

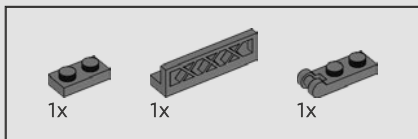

182

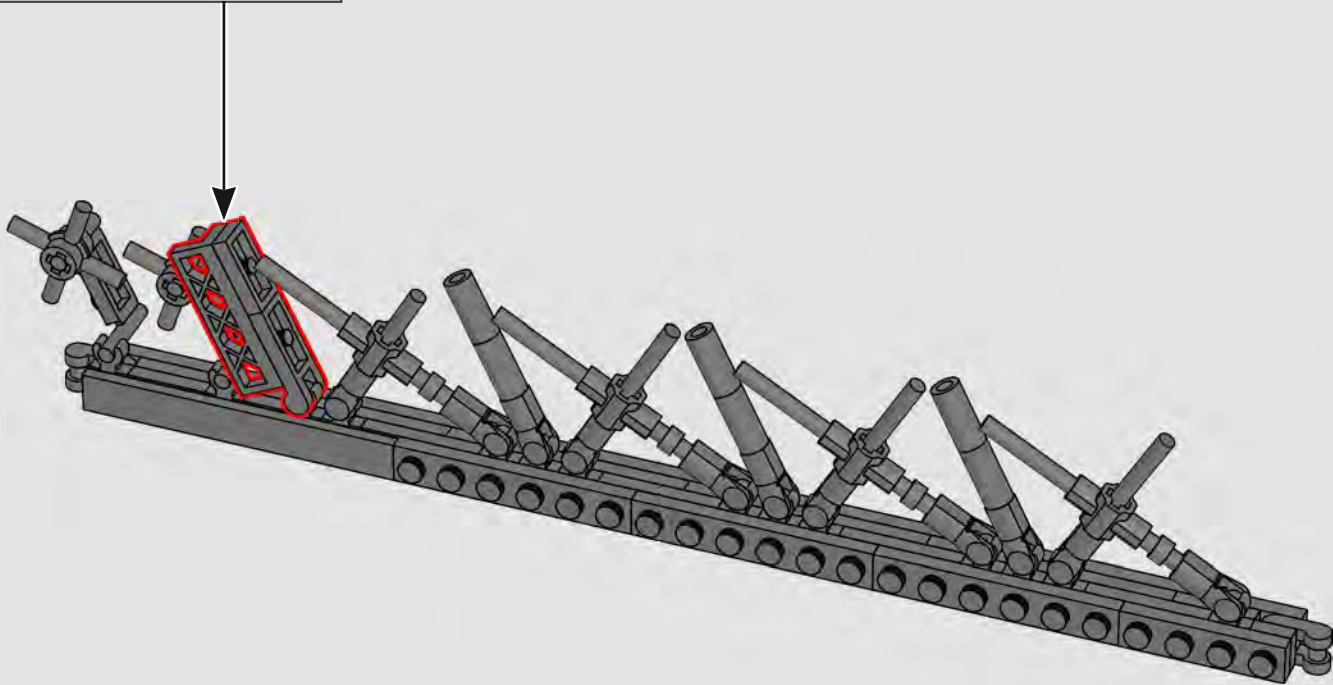
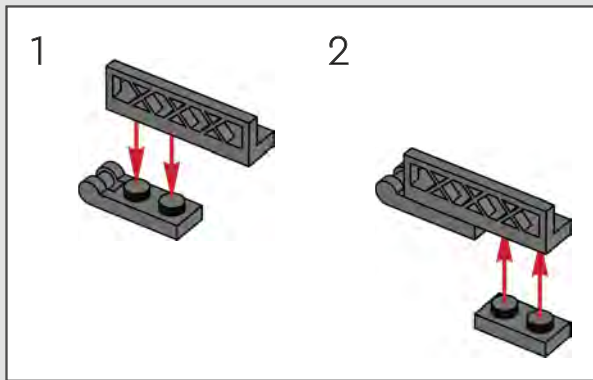

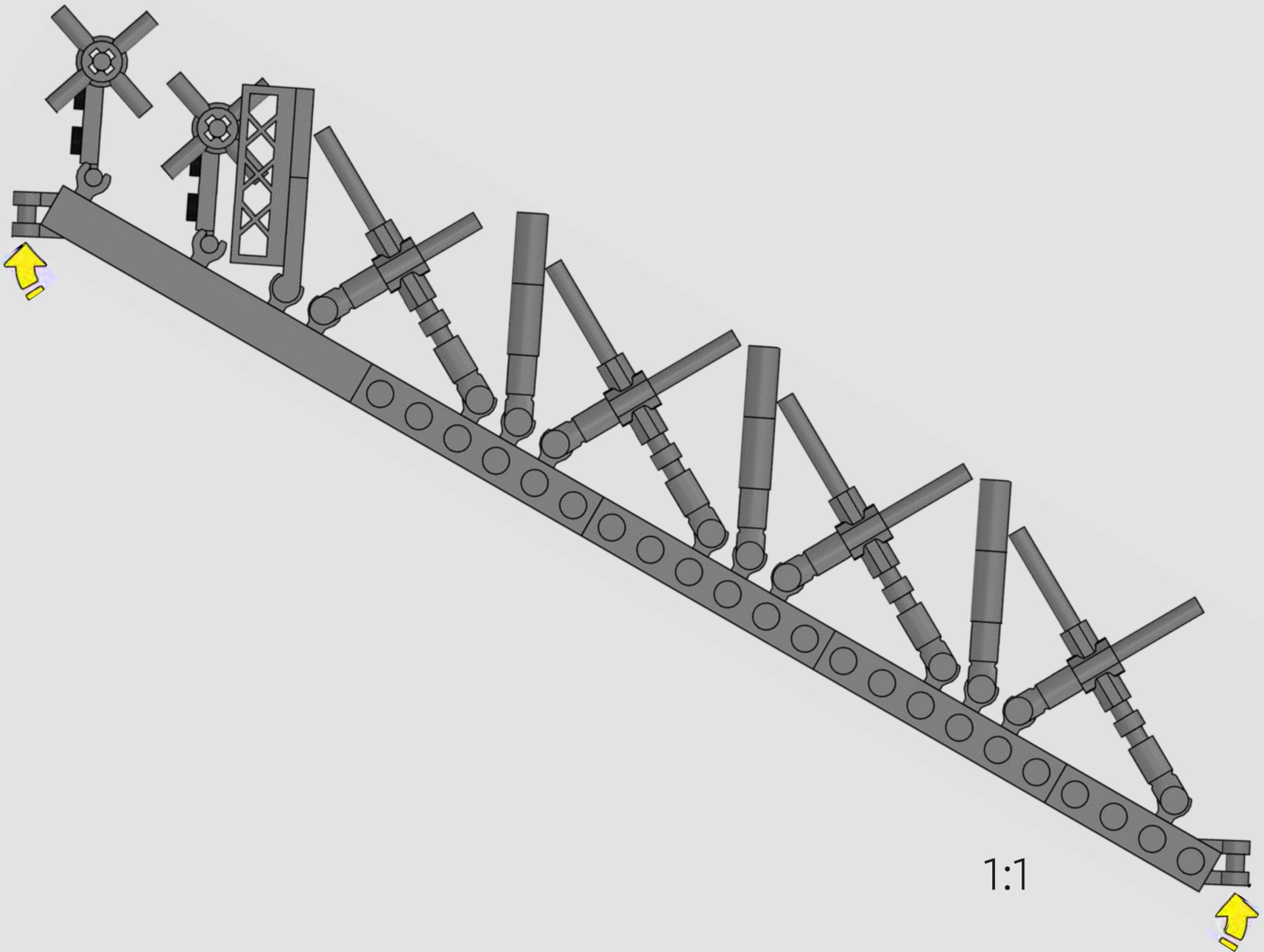

183

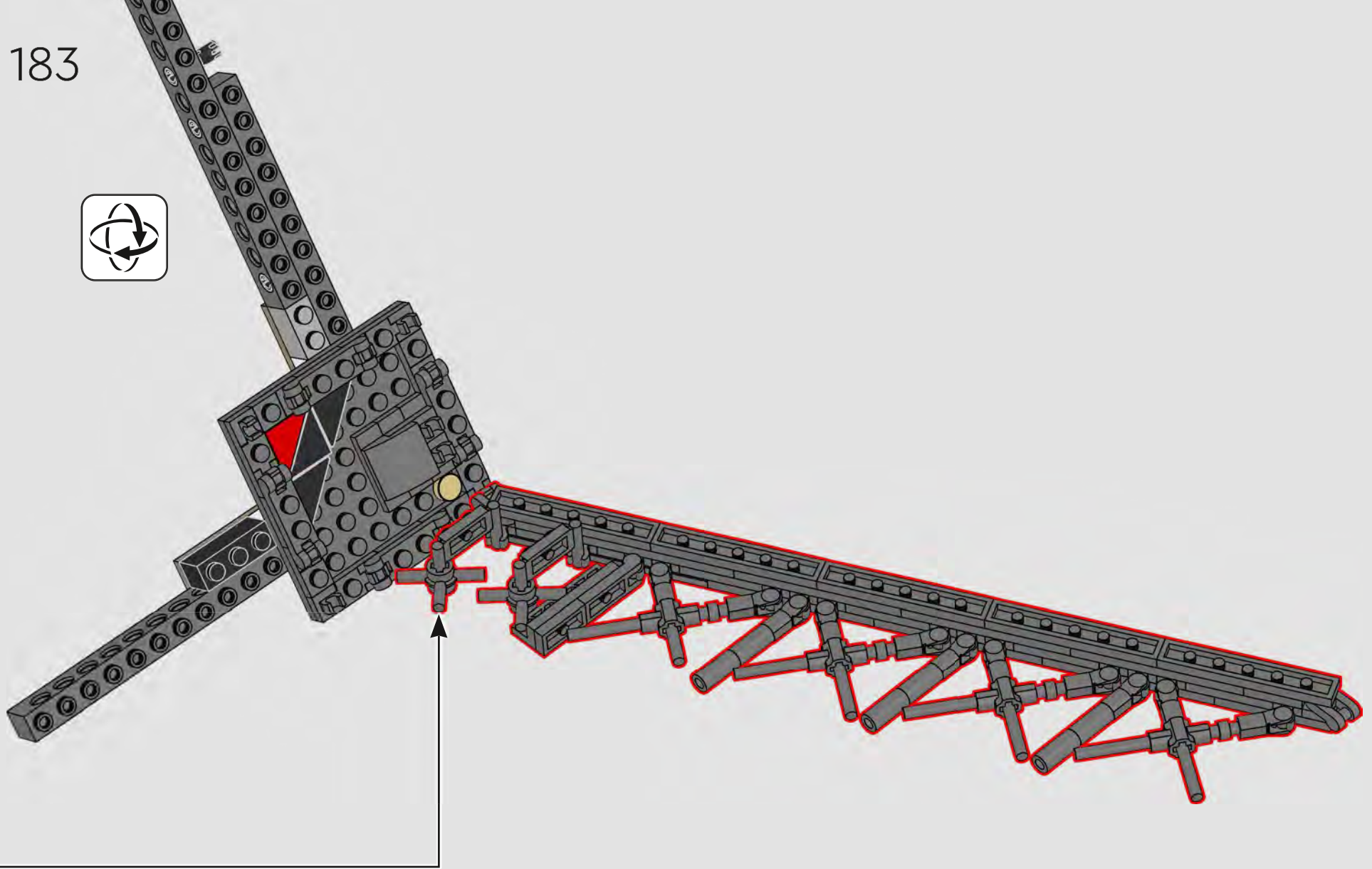

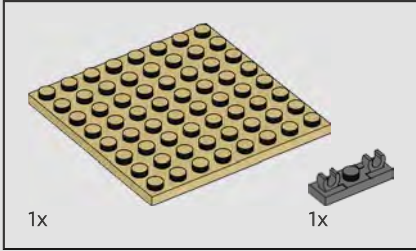
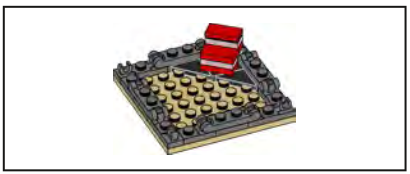

184

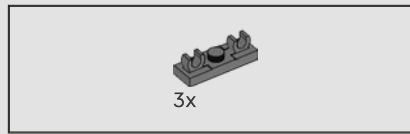
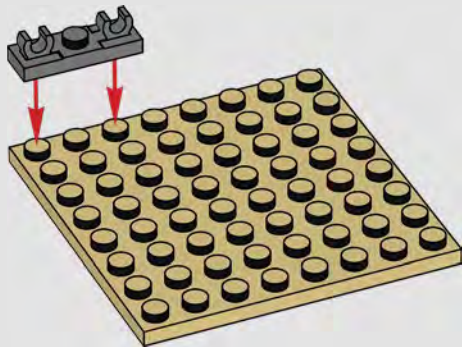

185

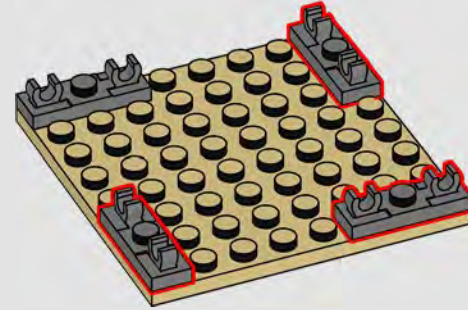

186

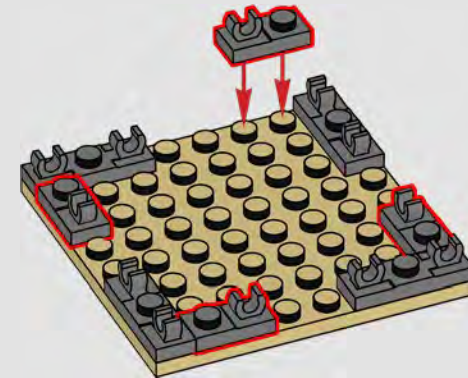

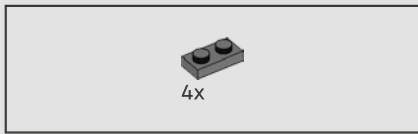

187

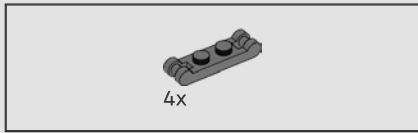
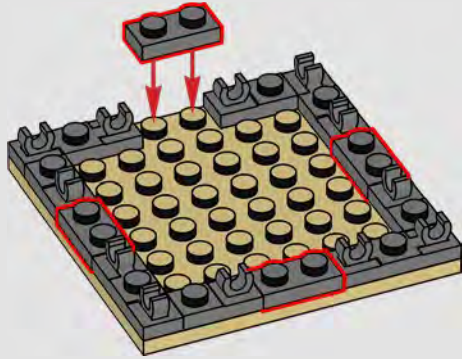

188

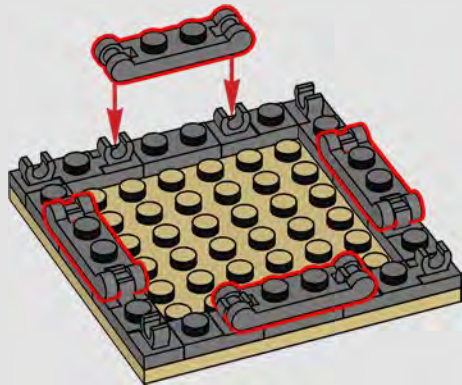

189

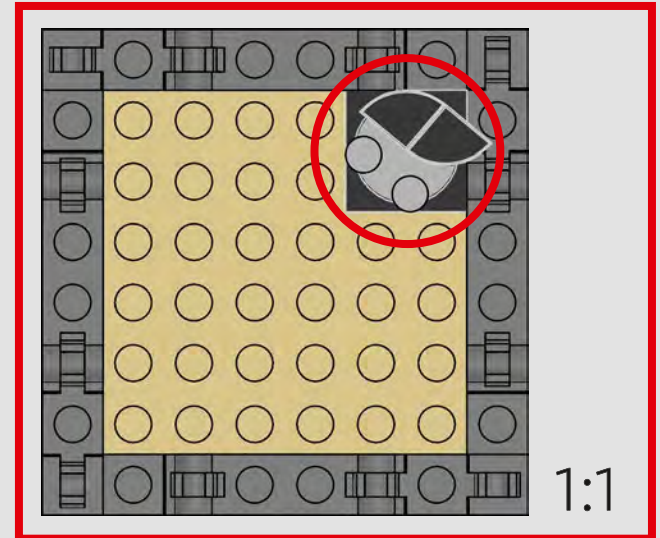
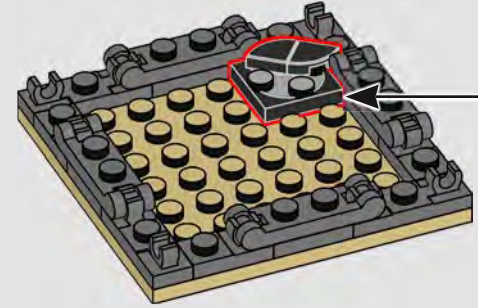
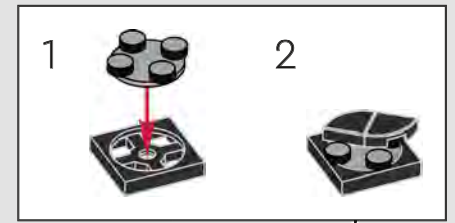



2x

190

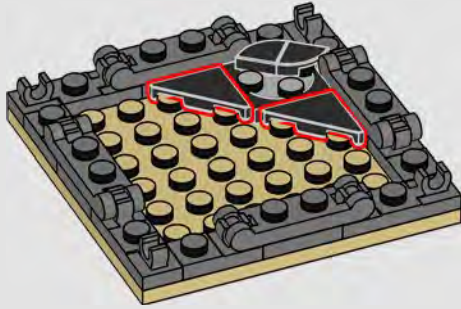

1x



1x

191

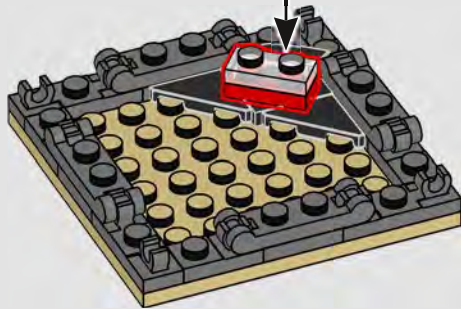
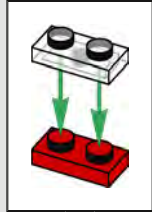

1x



1x



1x

192

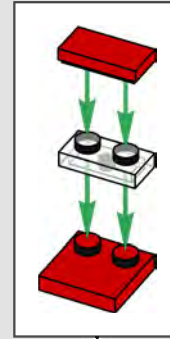

The lifts of the Eiffel tower are greased every day.
With beef fat.

193

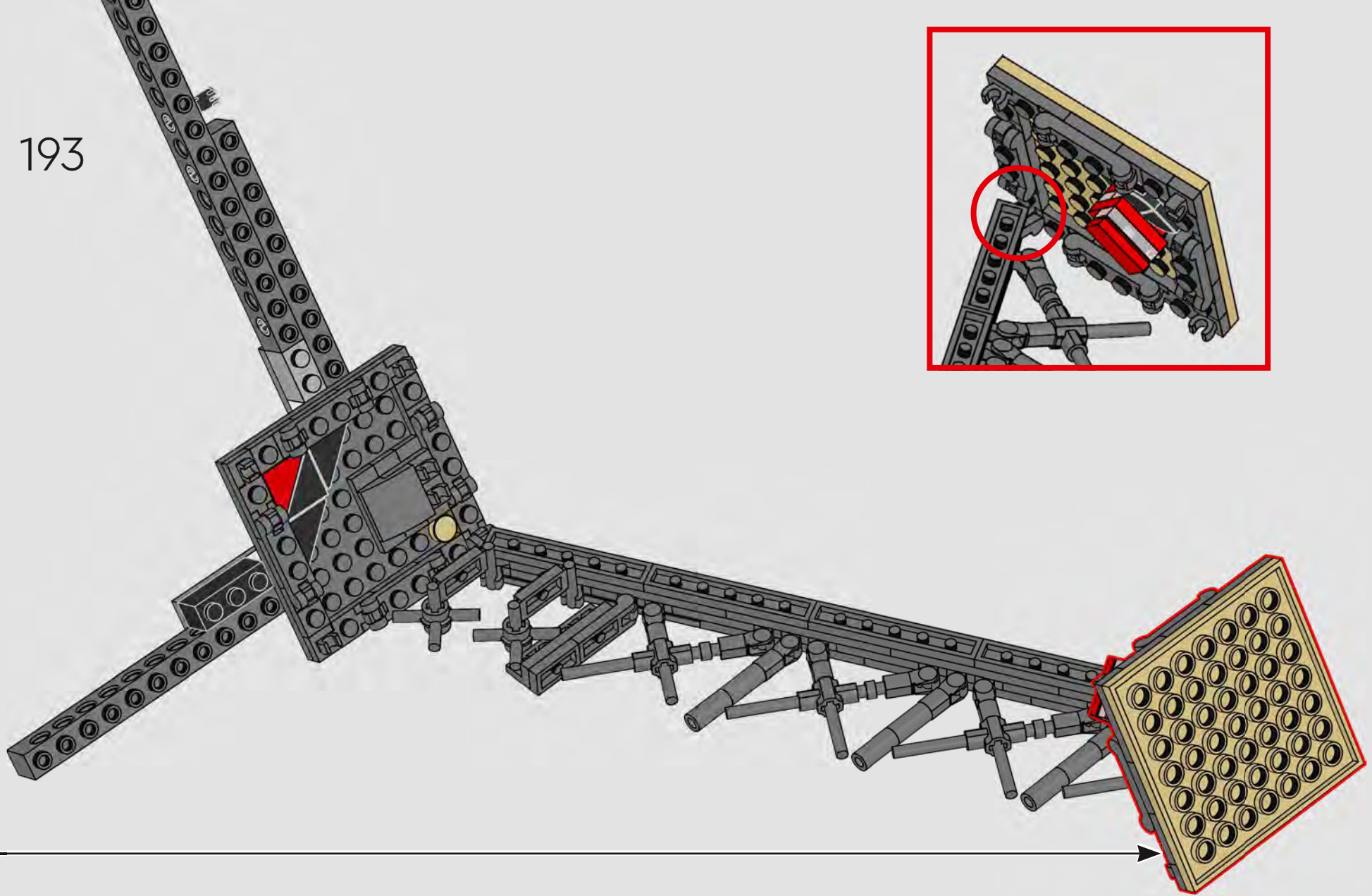

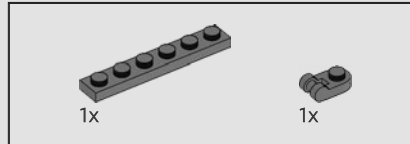
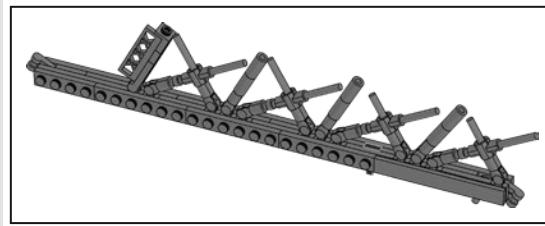

194

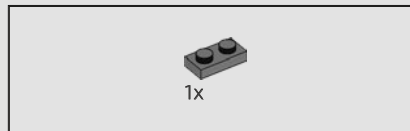
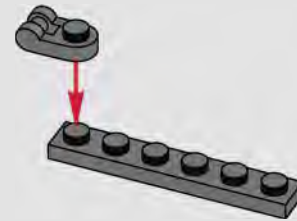

195

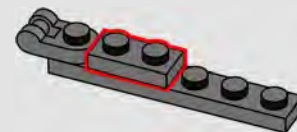

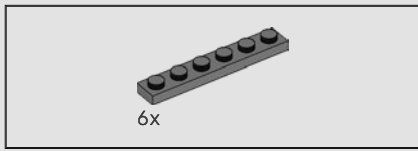

196

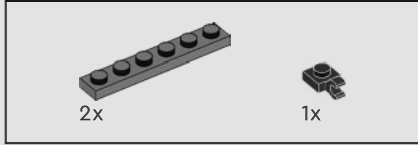
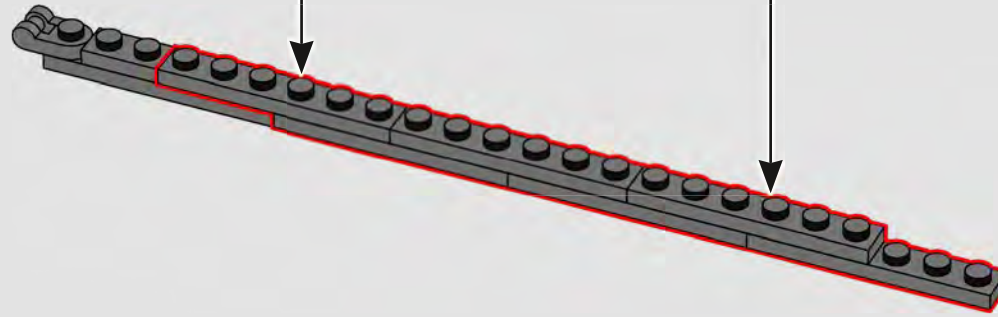
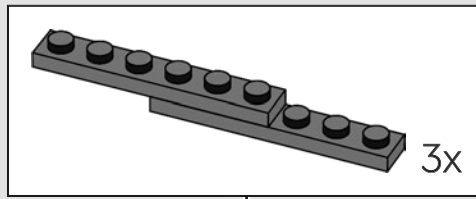

197

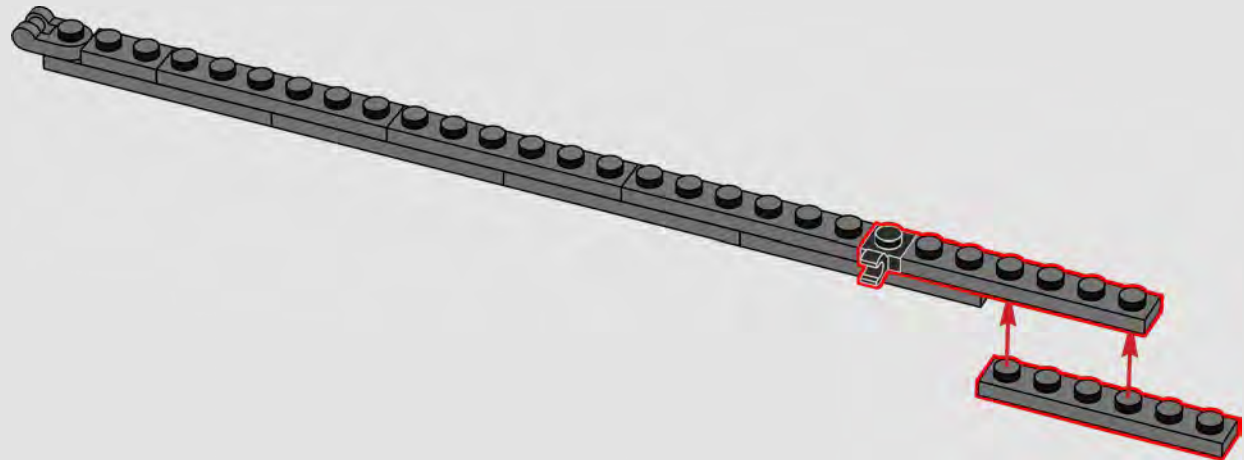



198

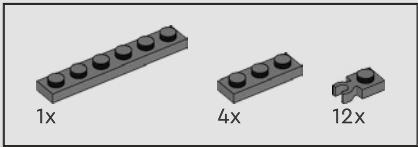
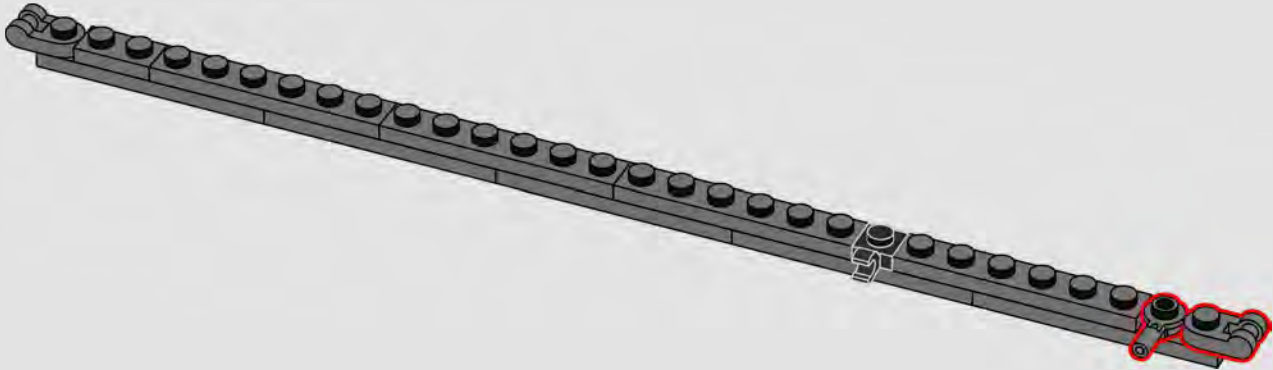

199

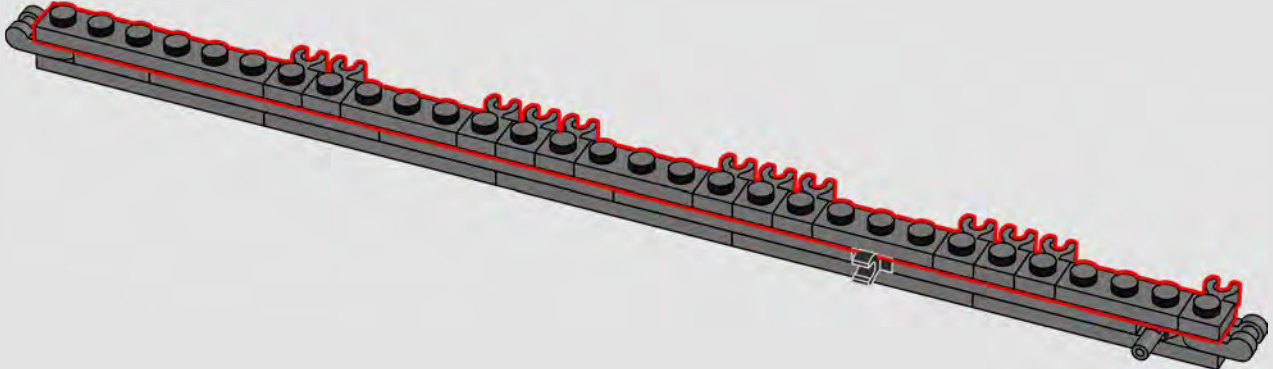

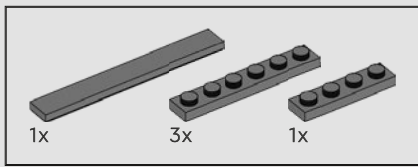

200

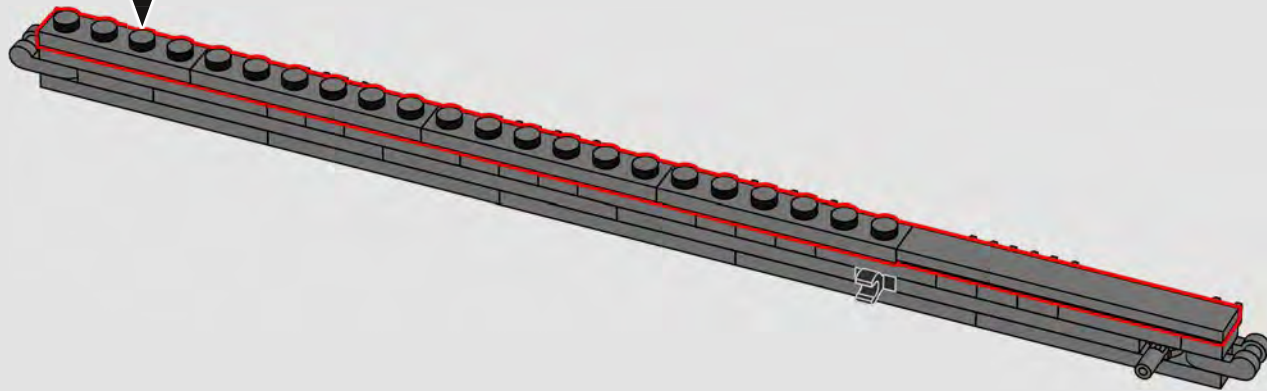
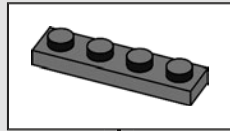

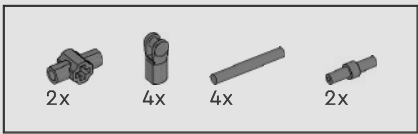

201

1 2 3

1:1 1:1

1:1 2x

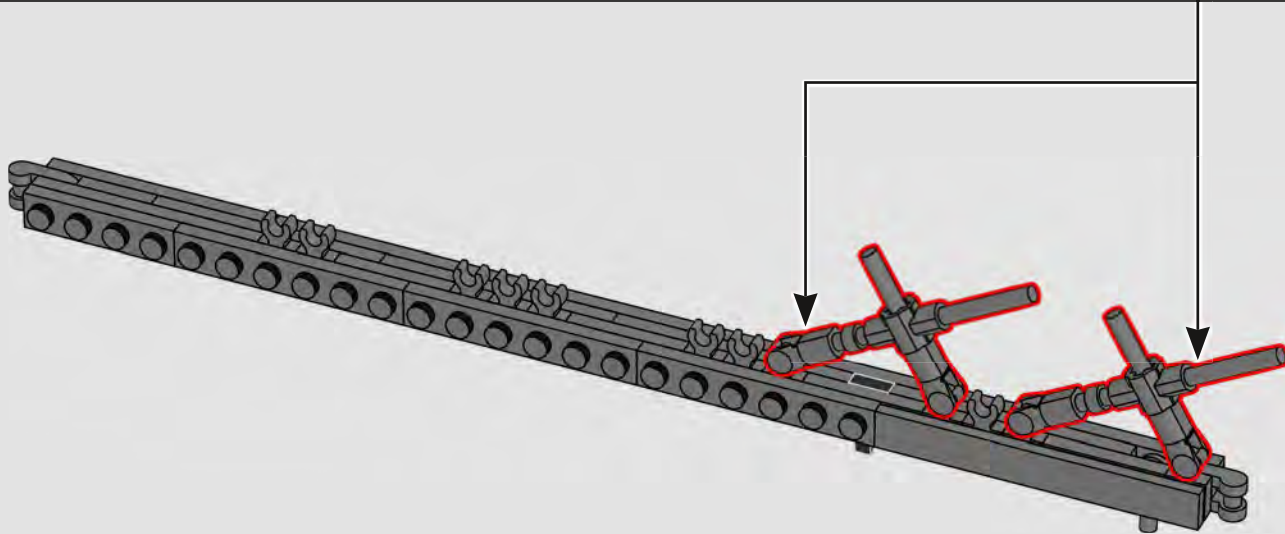

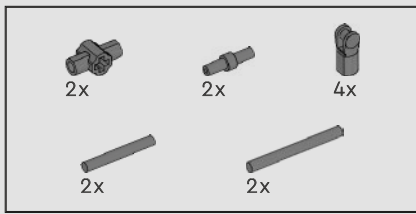

202

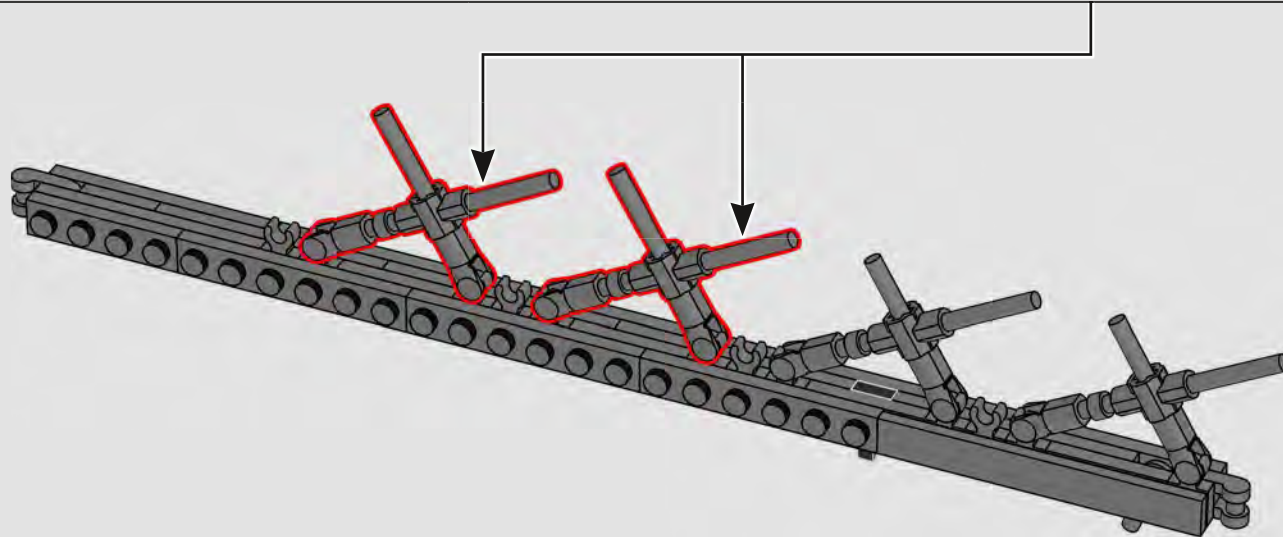
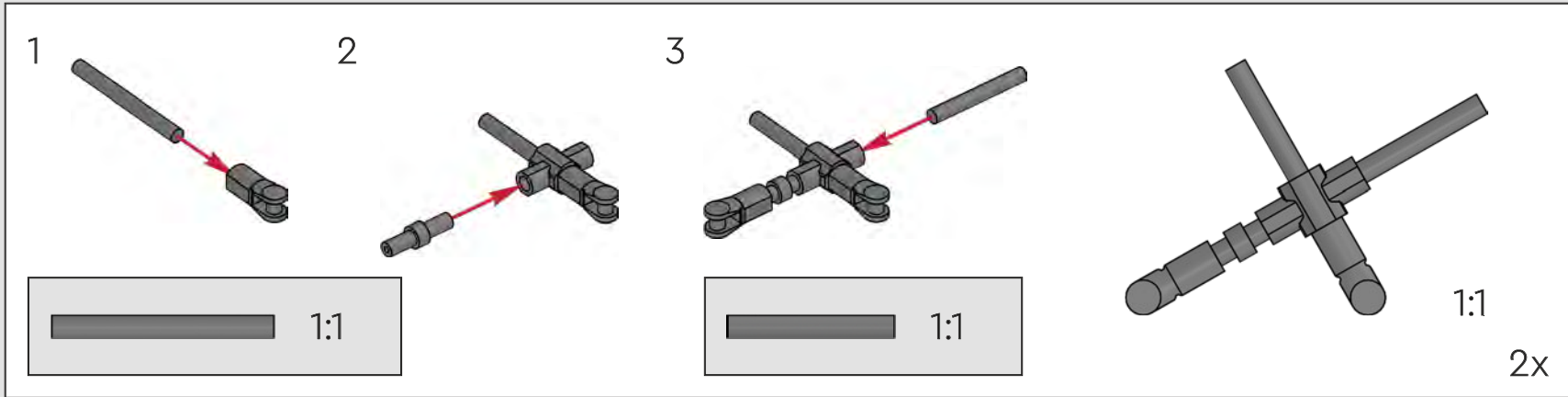

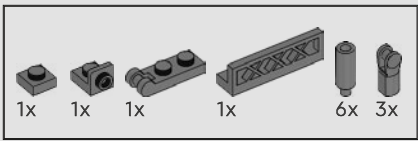

203

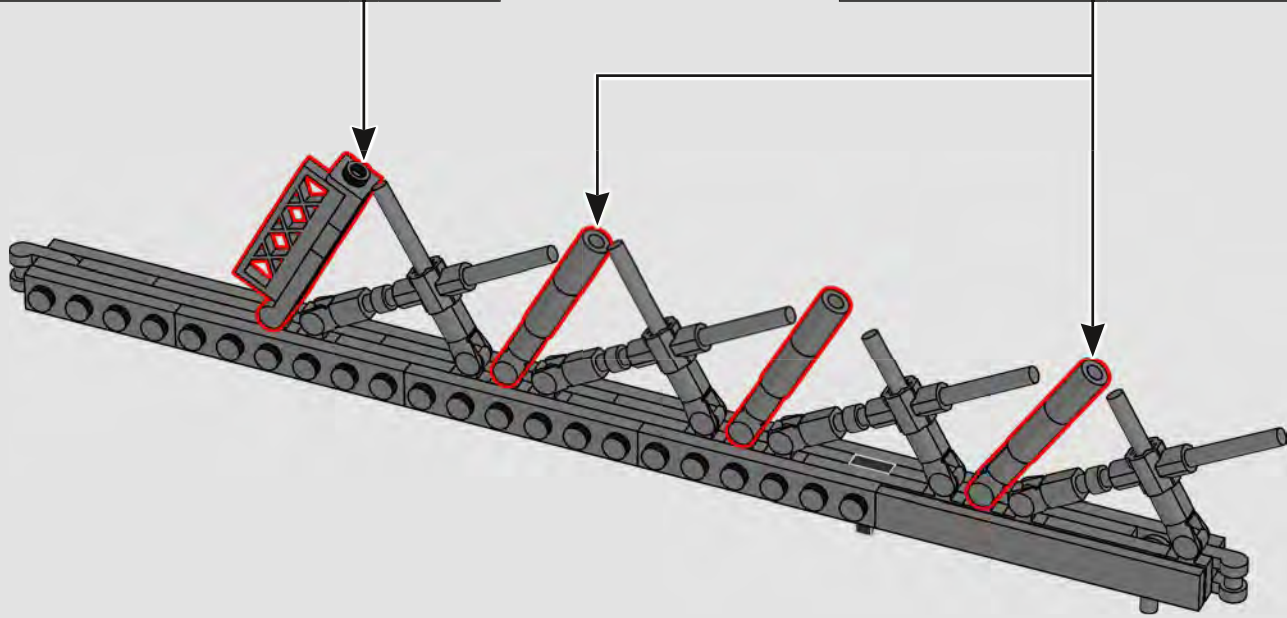
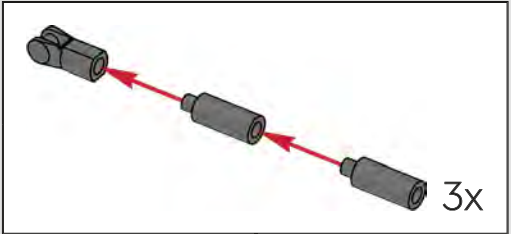
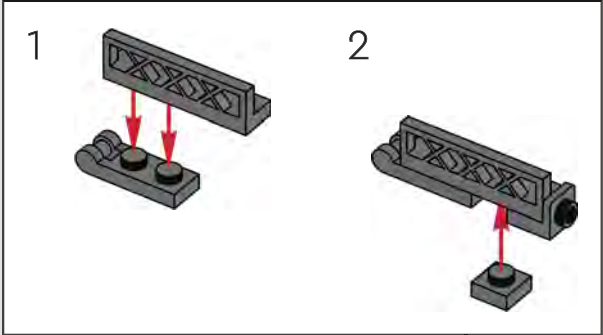

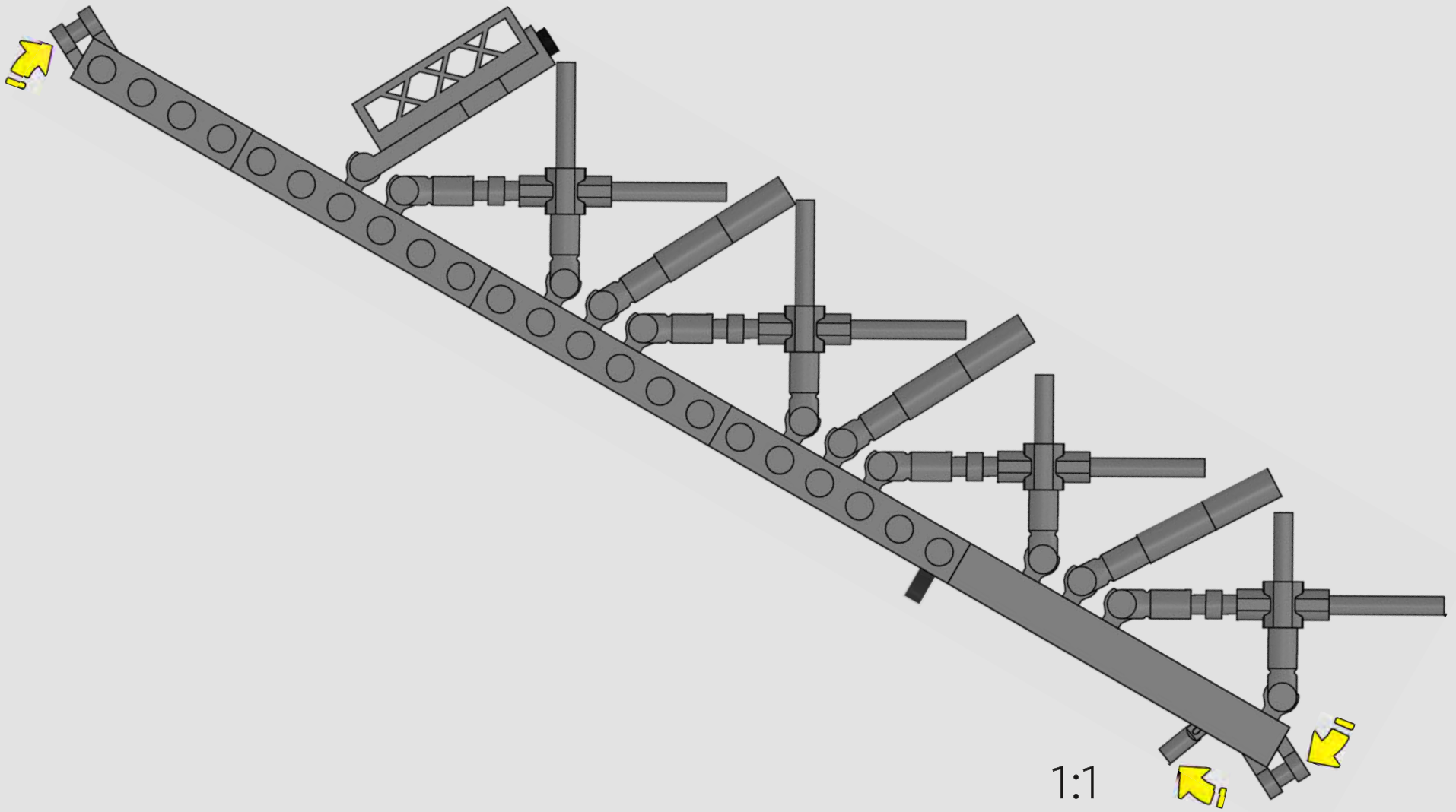

204

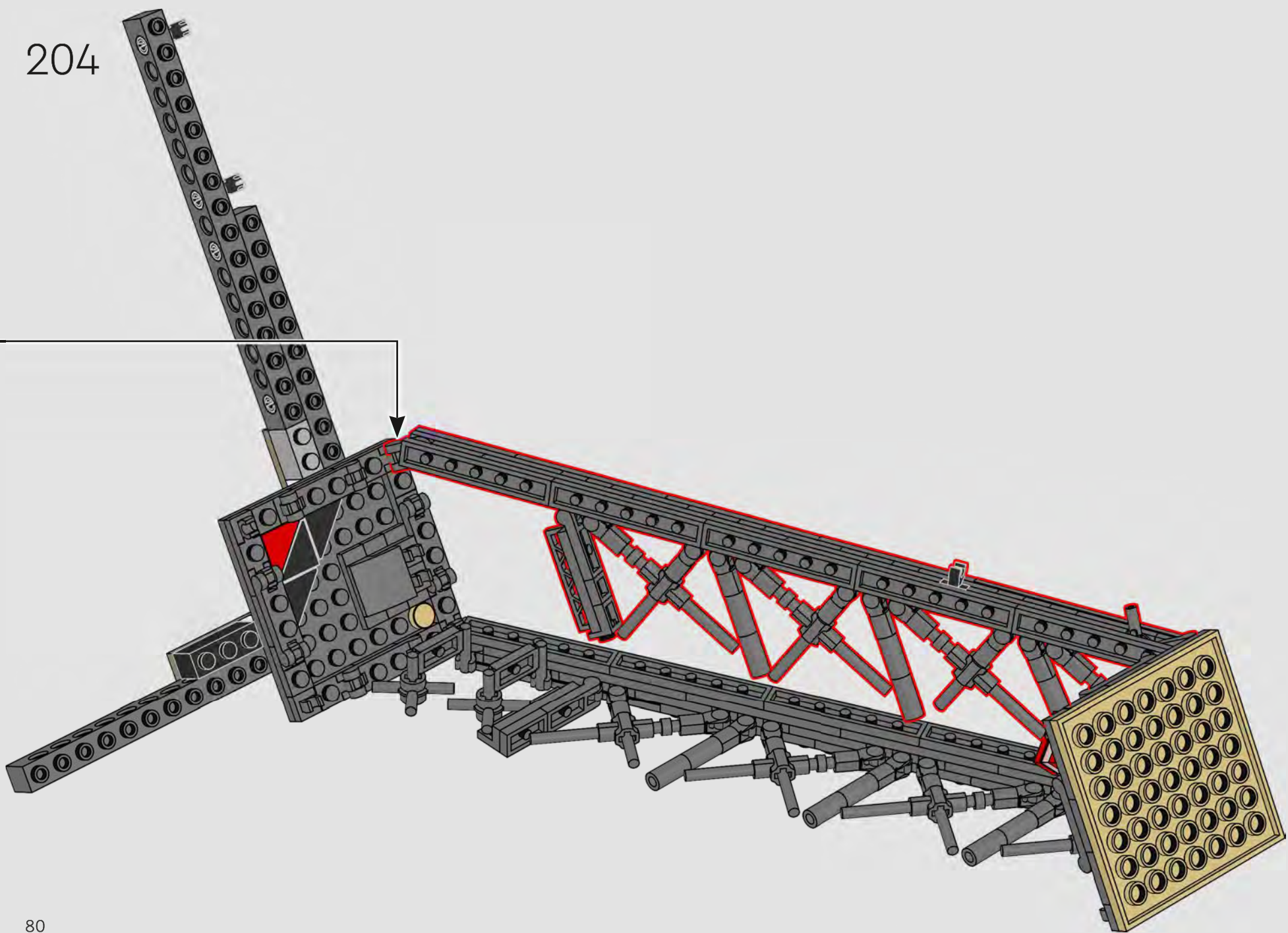

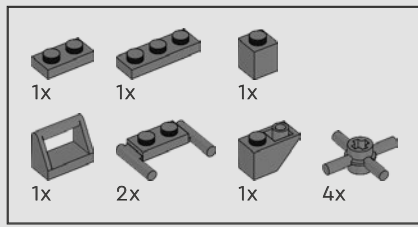

205

1

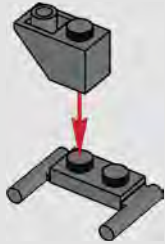

2

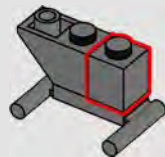

3

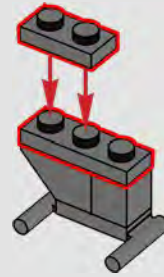

4

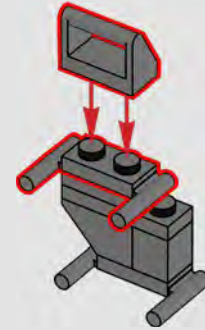

5

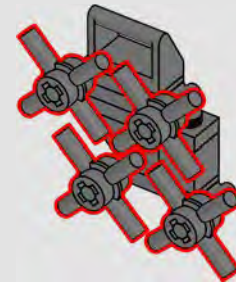

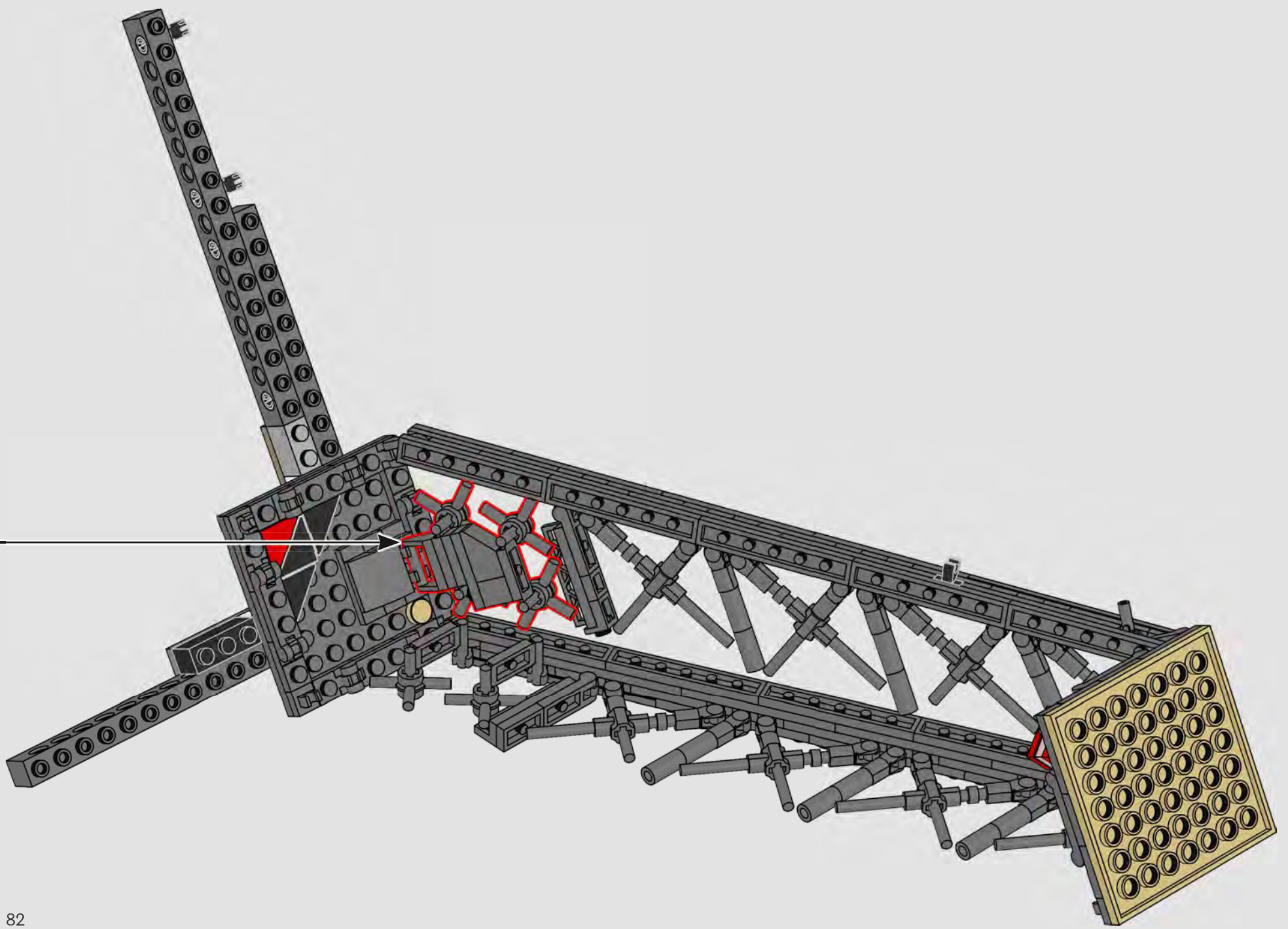

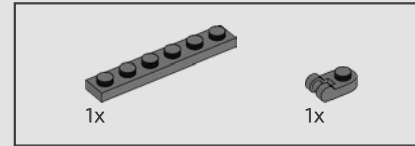
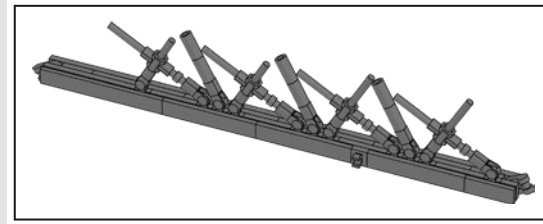

206

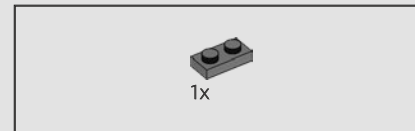
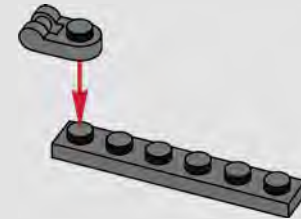

207

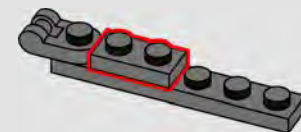

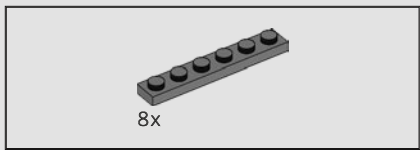

208

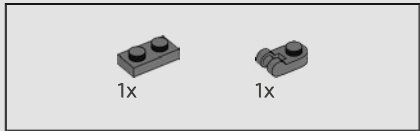
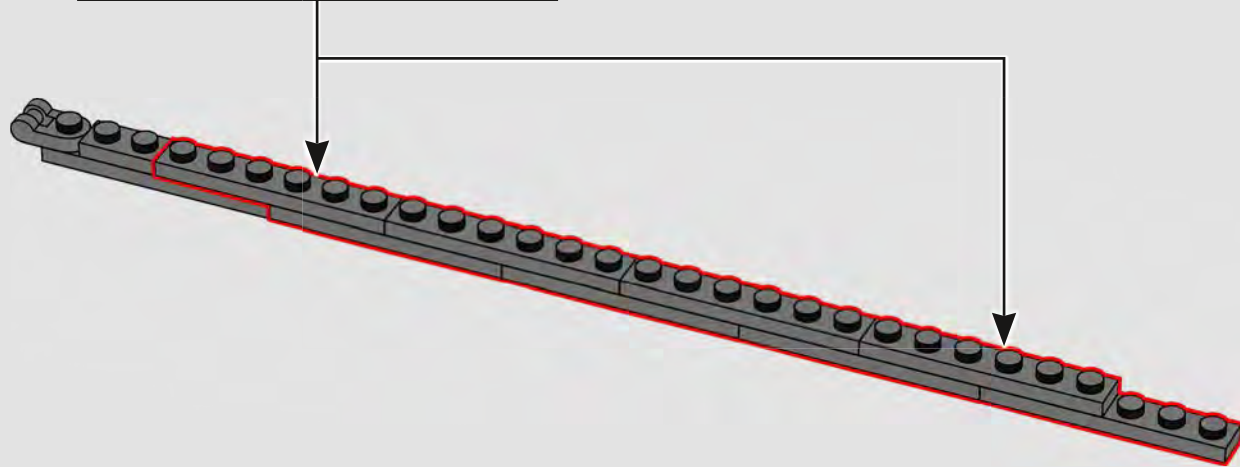
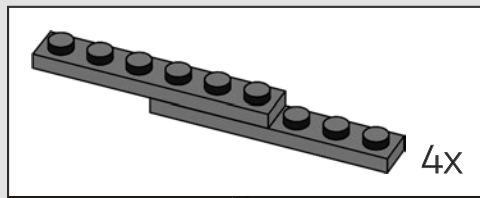

209

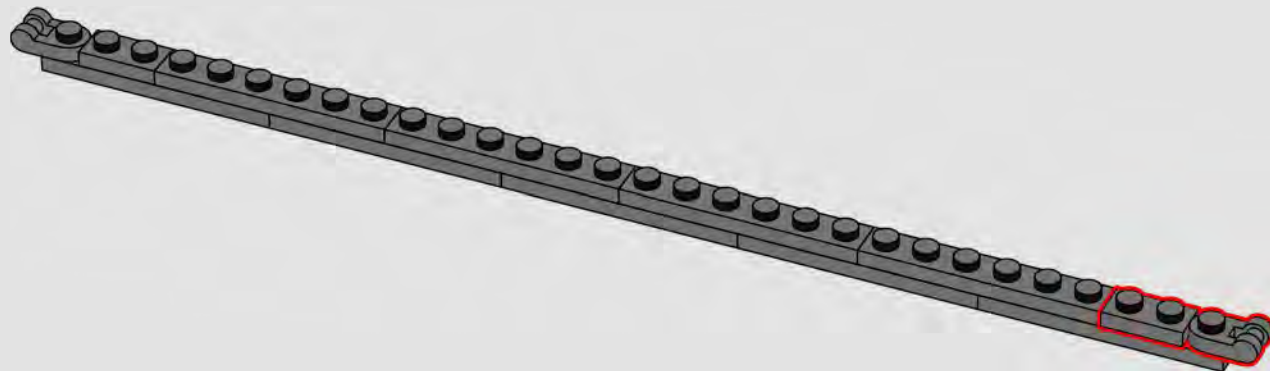

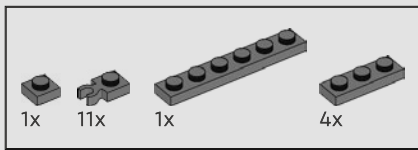

210

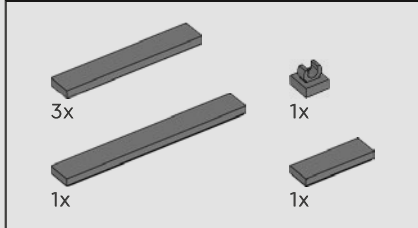
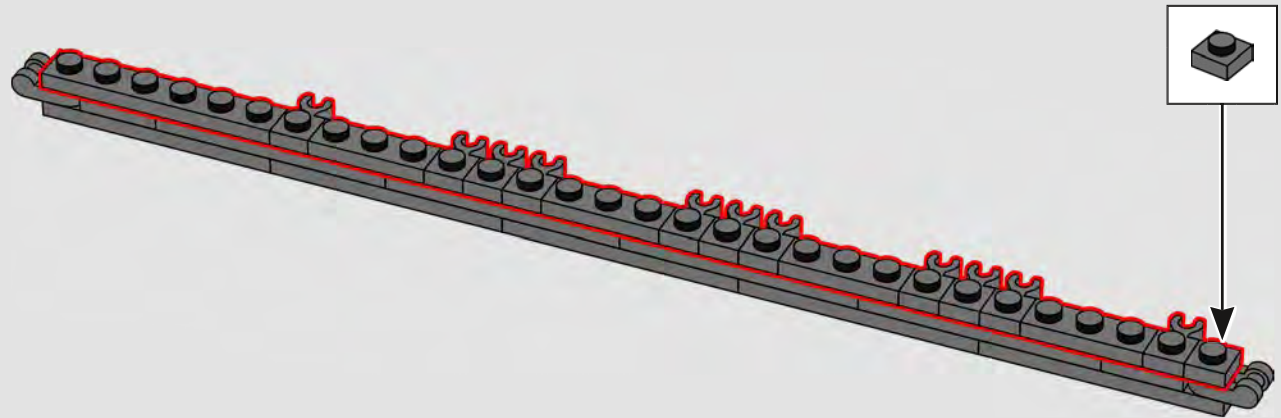

211

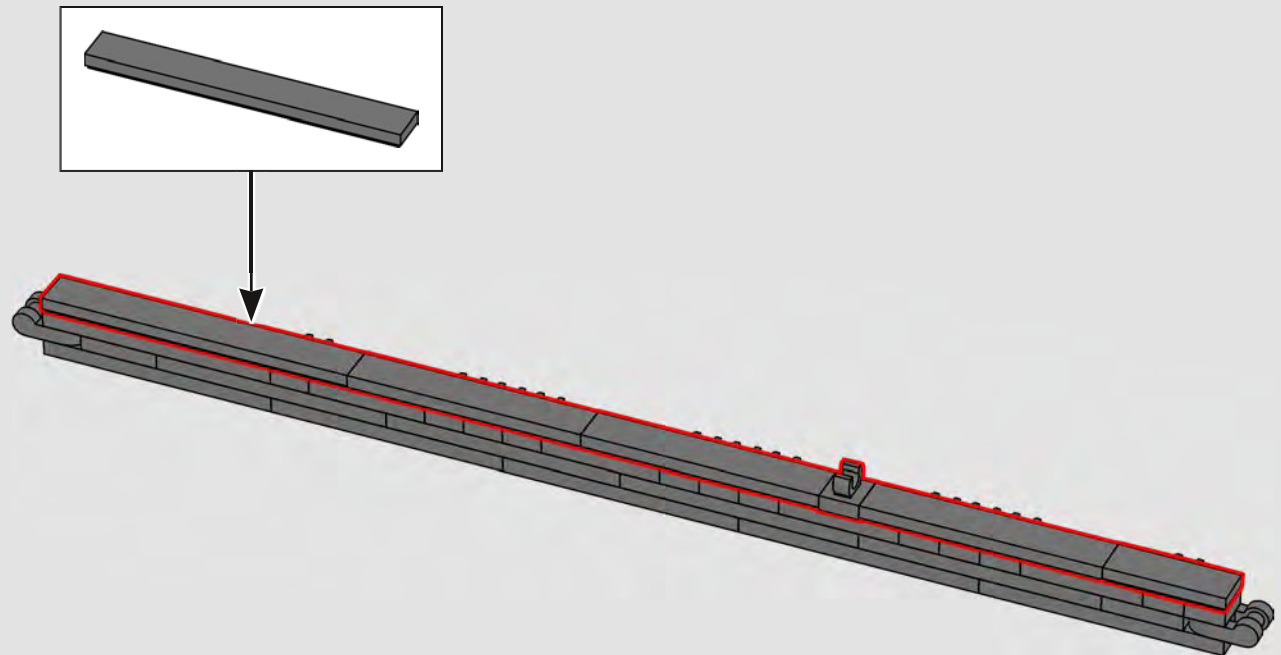

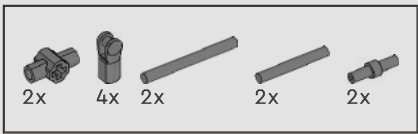

212

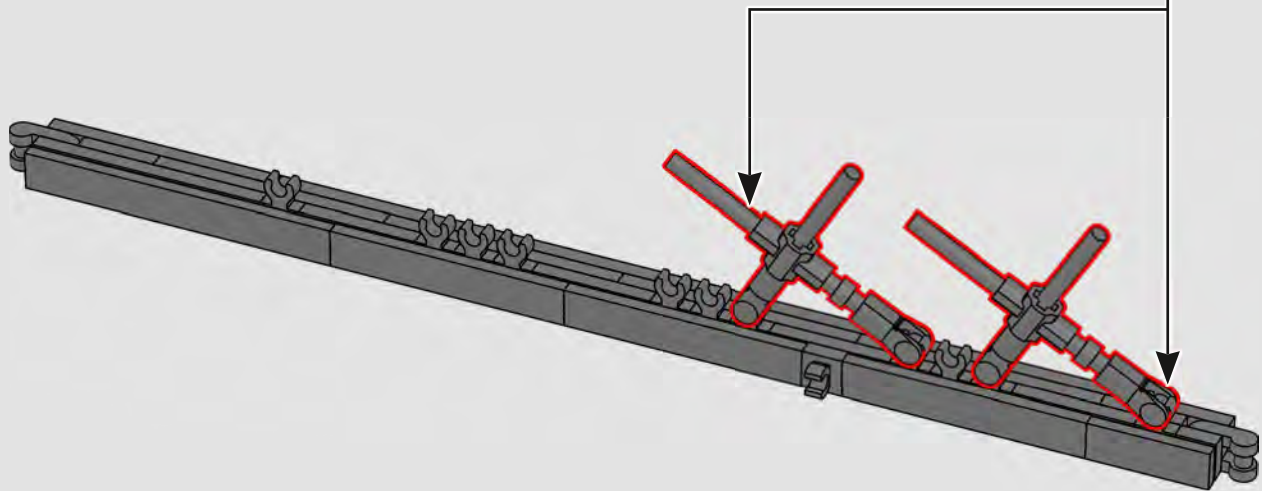
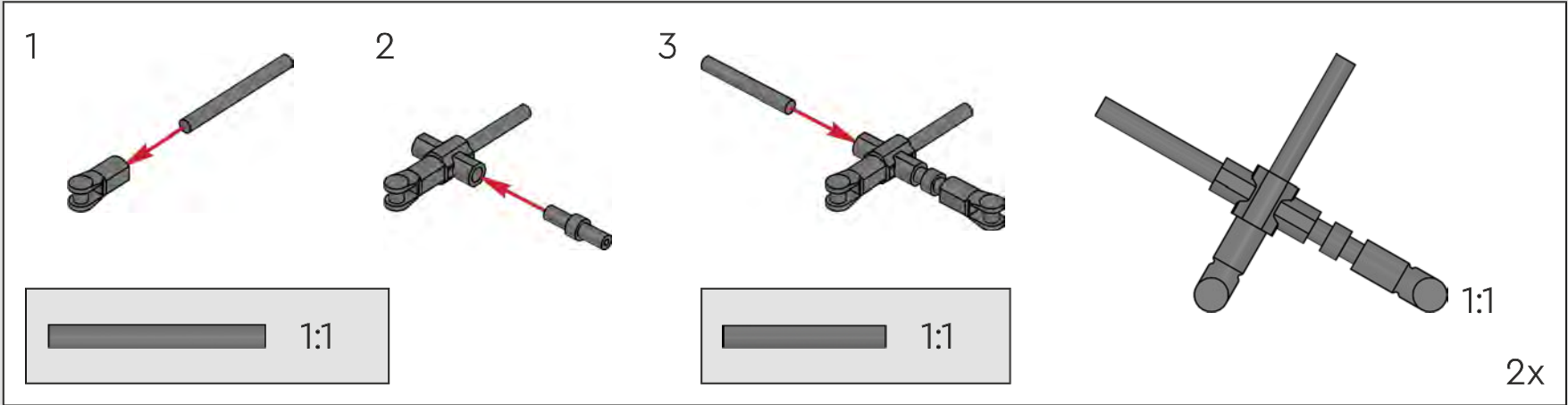

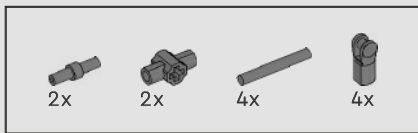

213

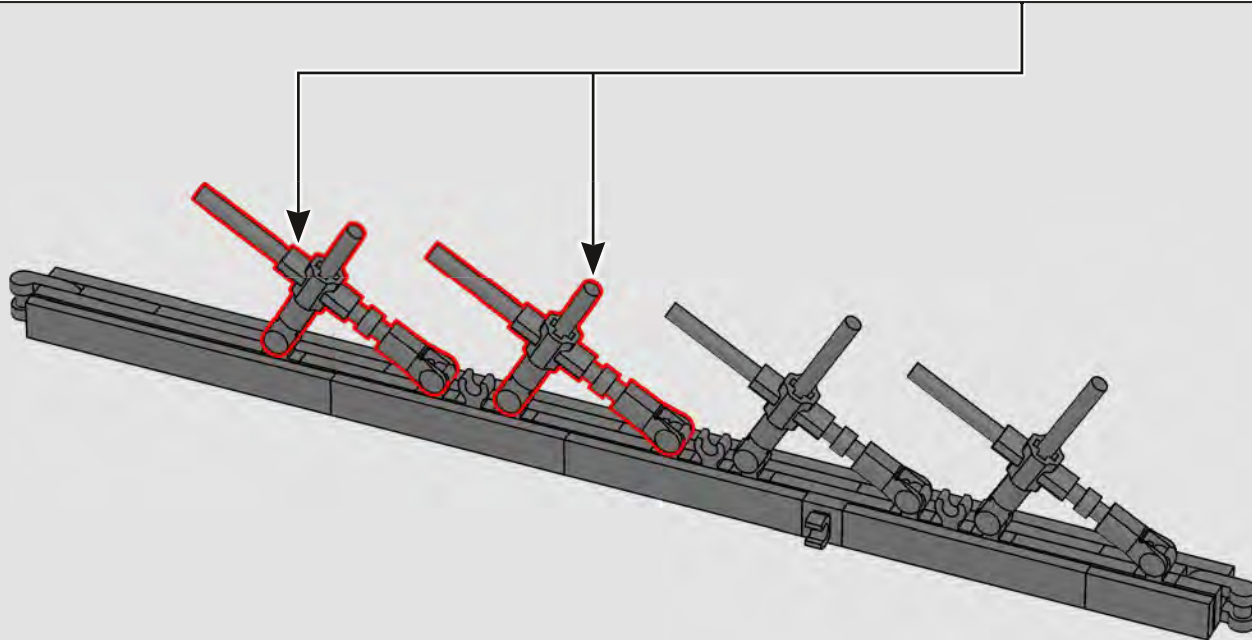
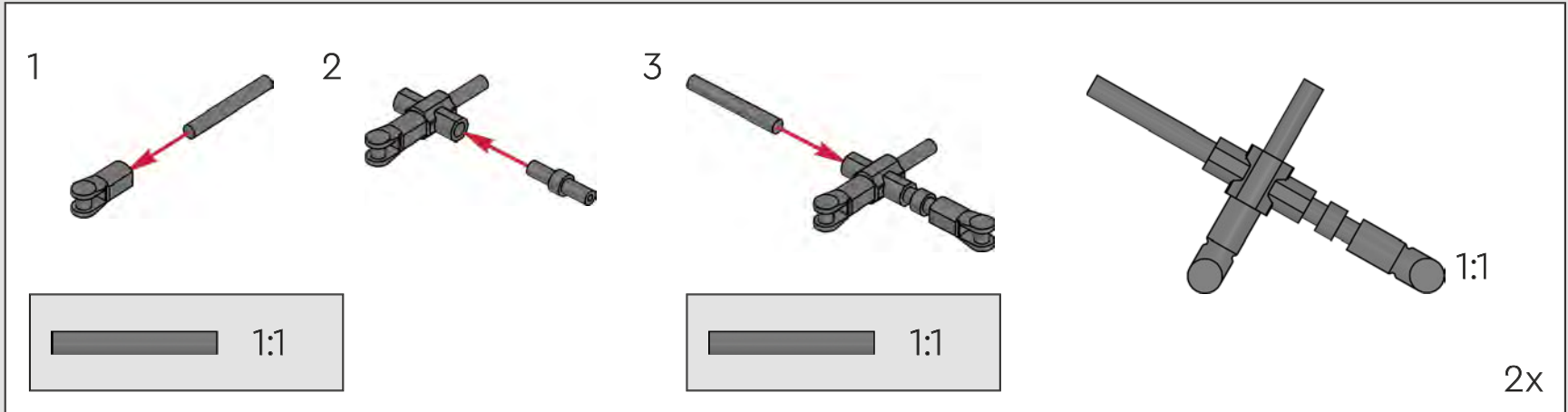

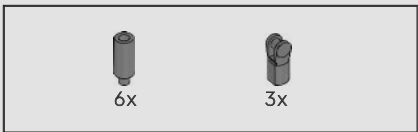

214

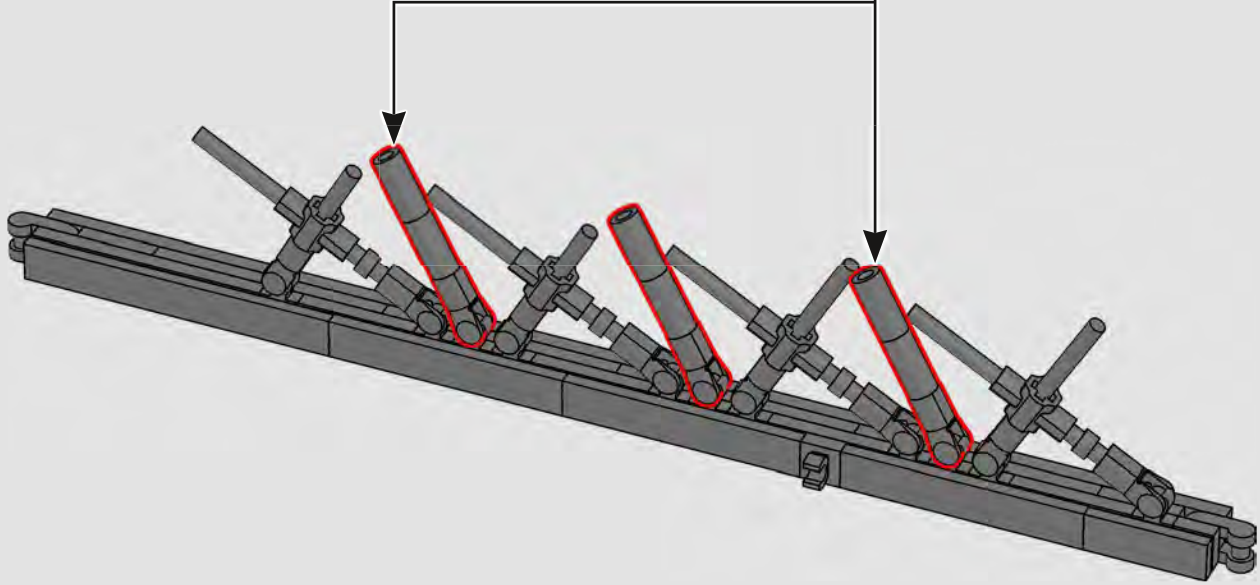
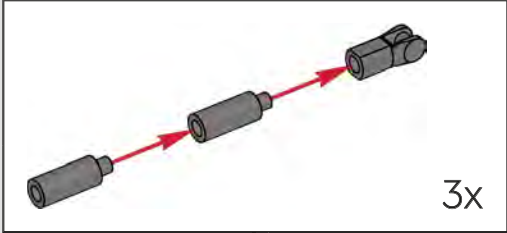

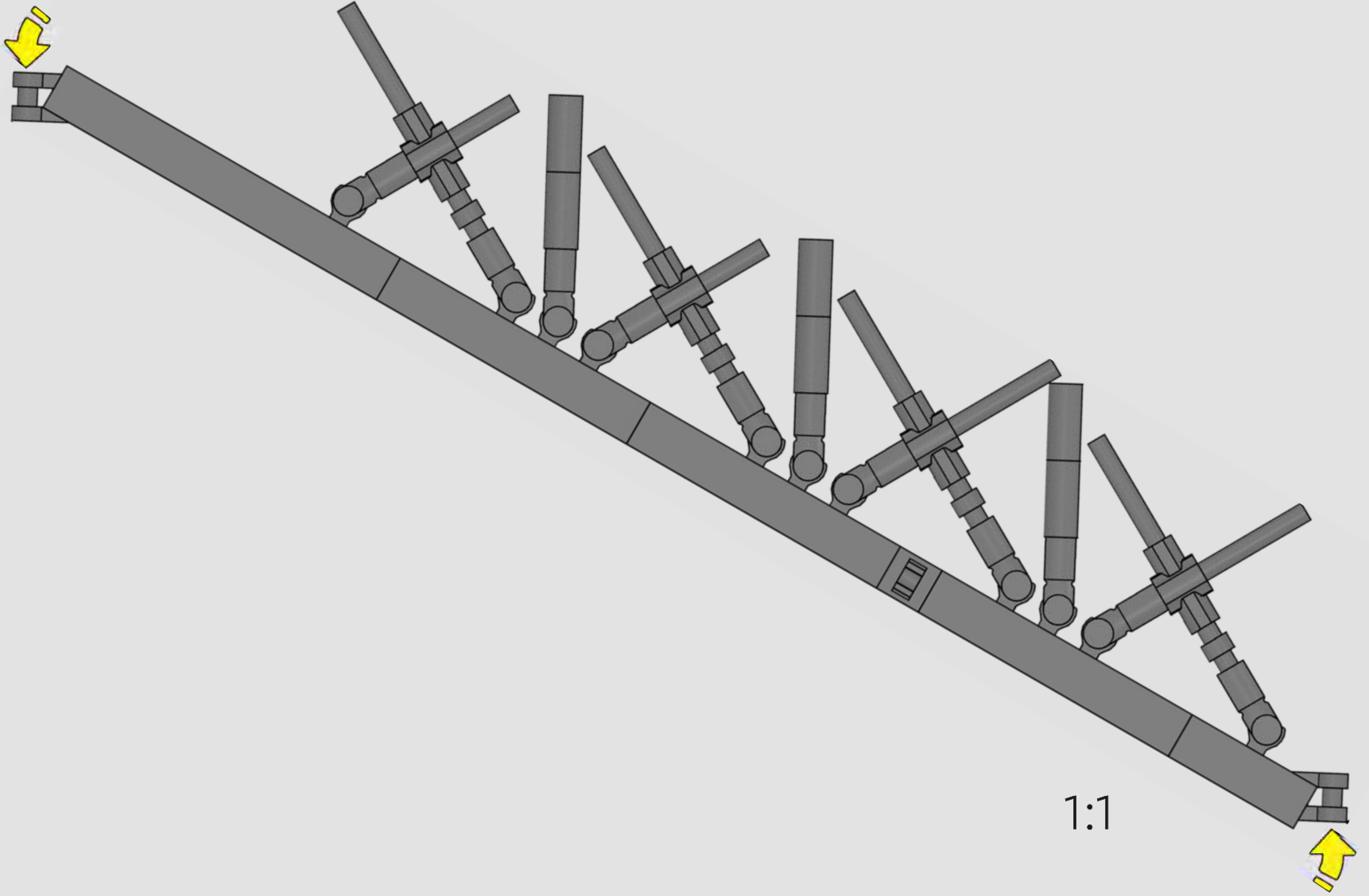

215

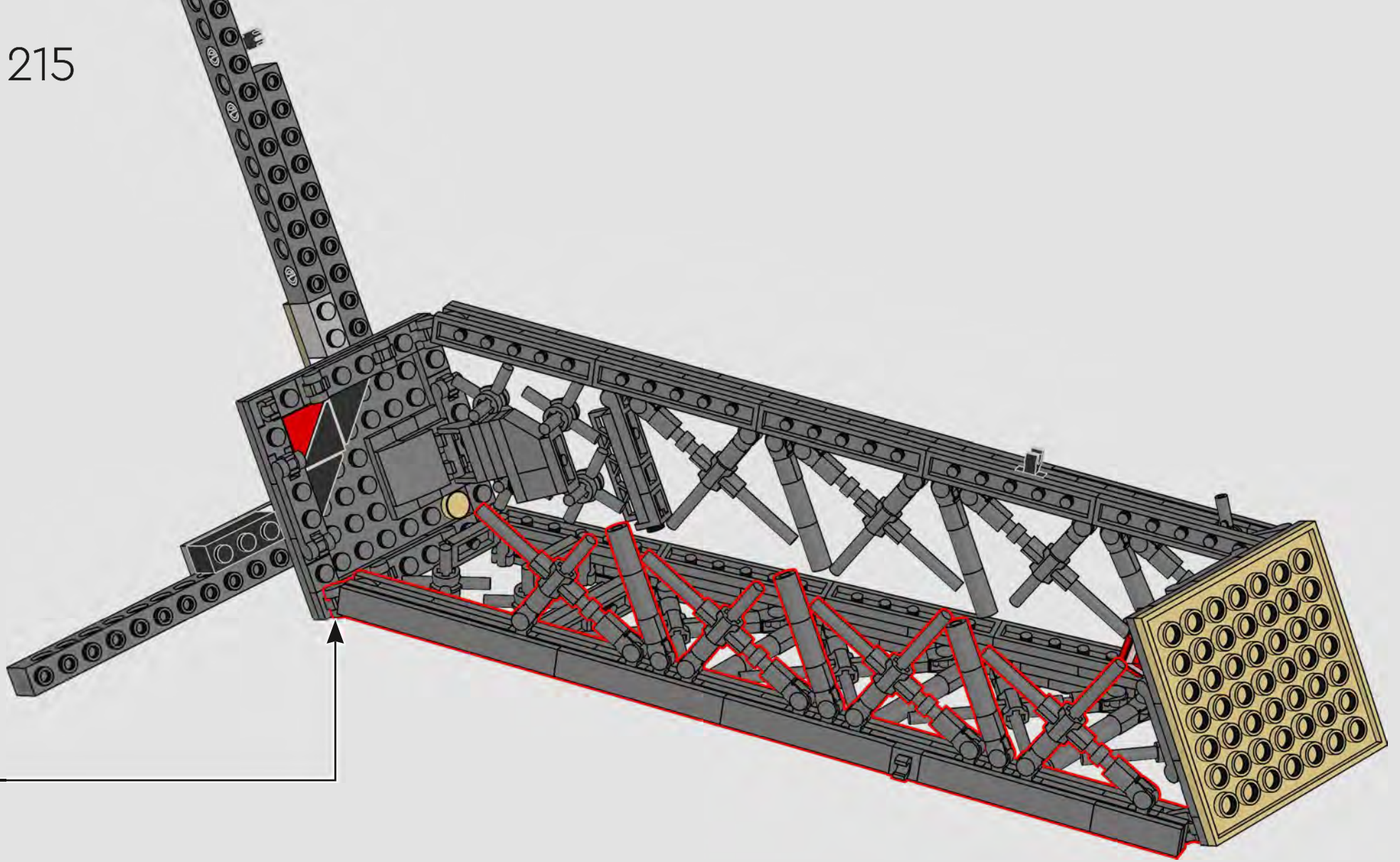

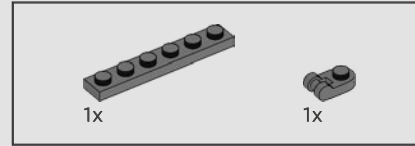
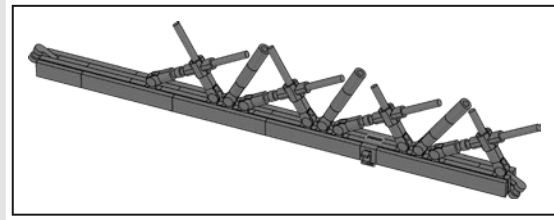

216

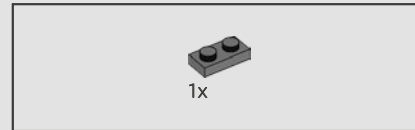
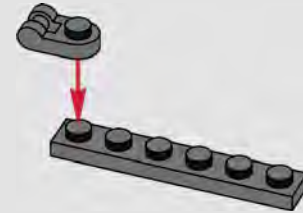

217

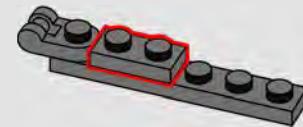

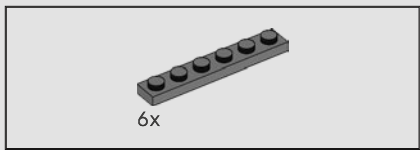

218

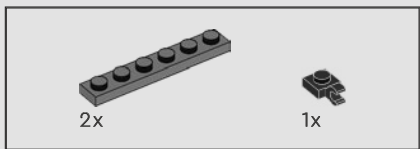
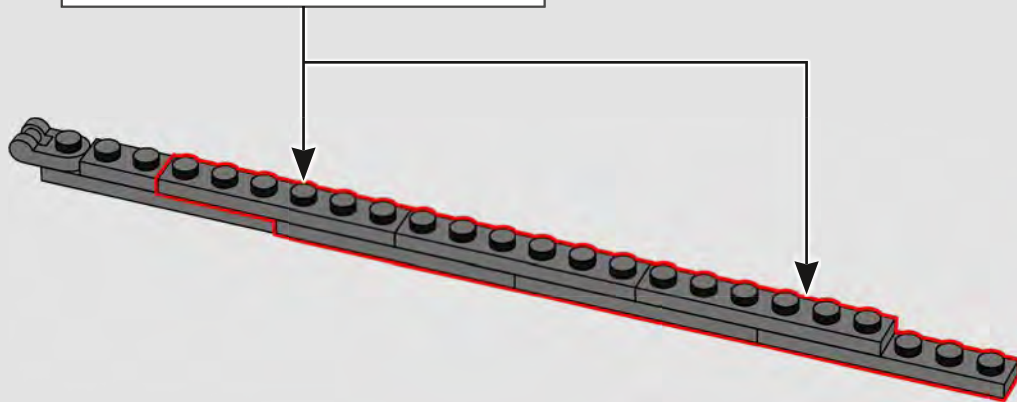
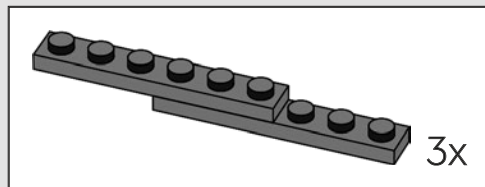

219

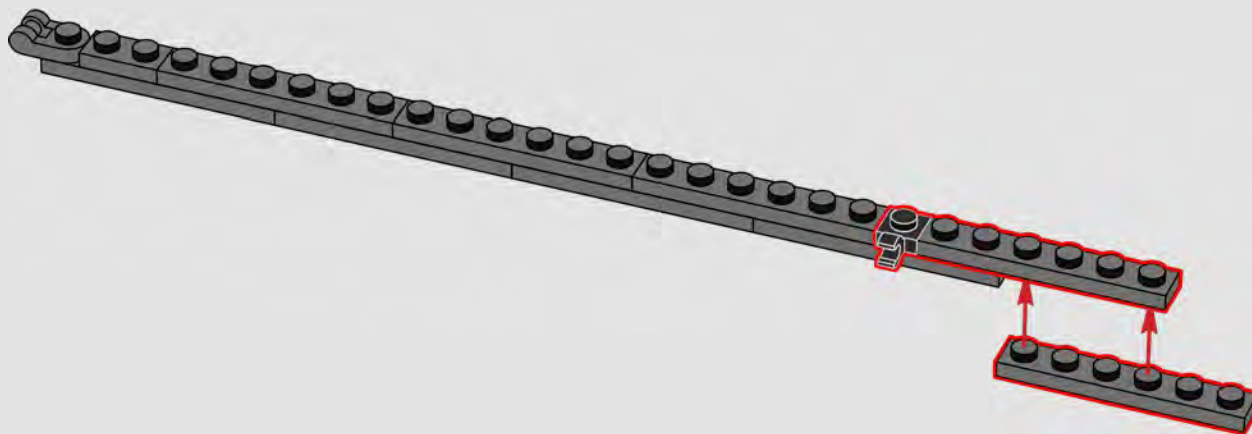

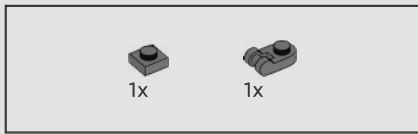

220

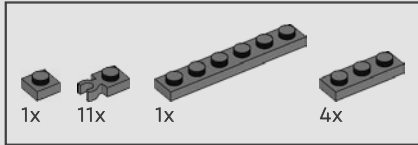
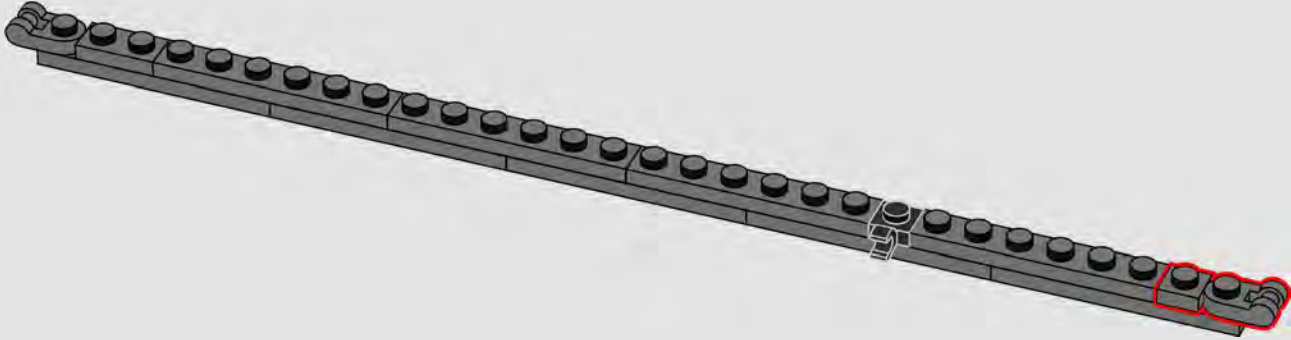

221

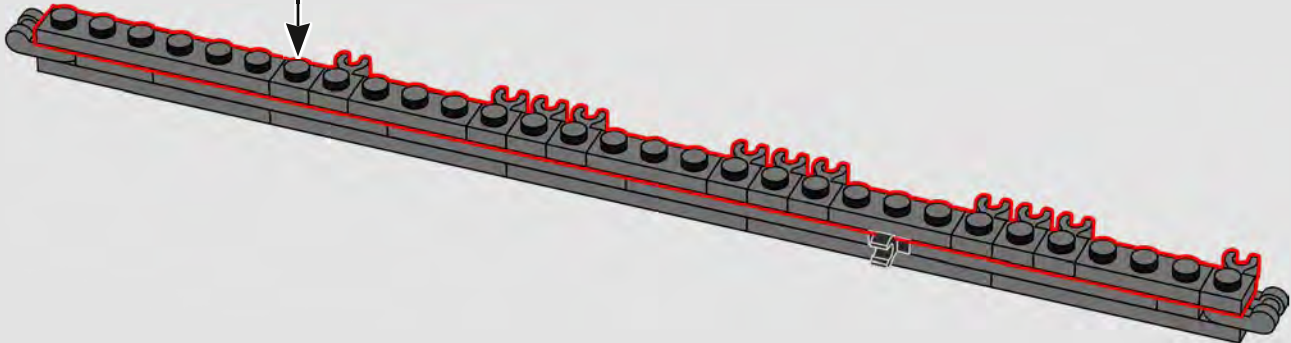
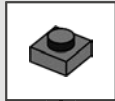

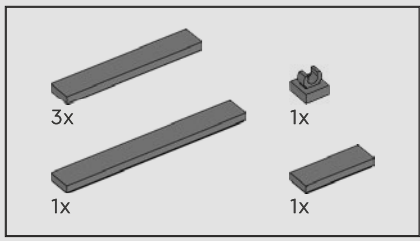

222

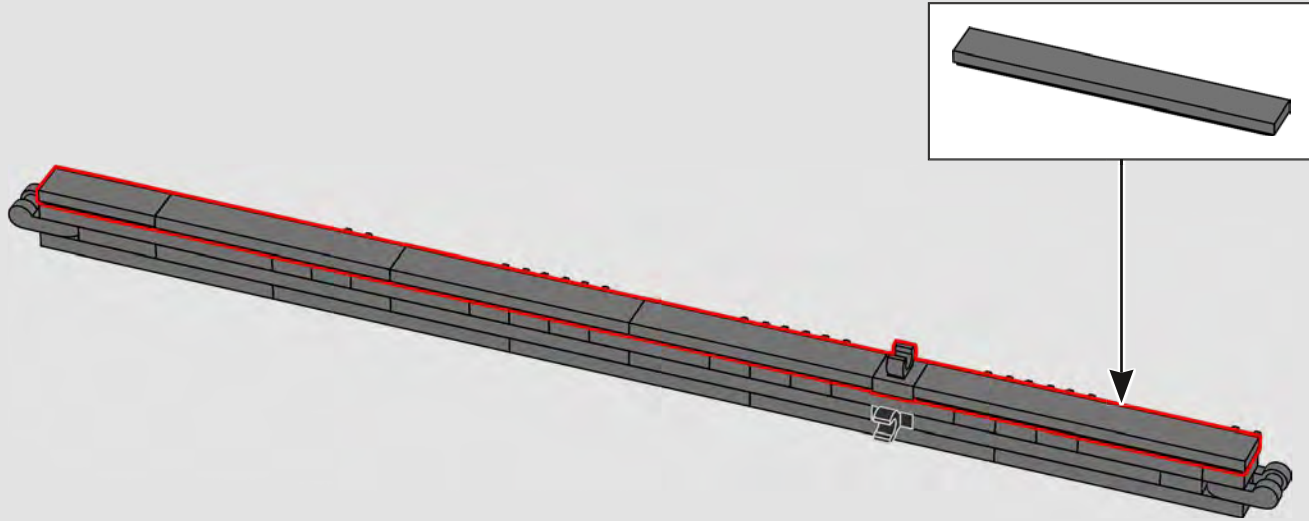

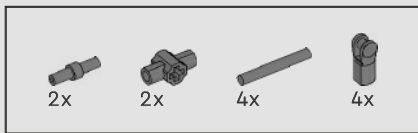

223

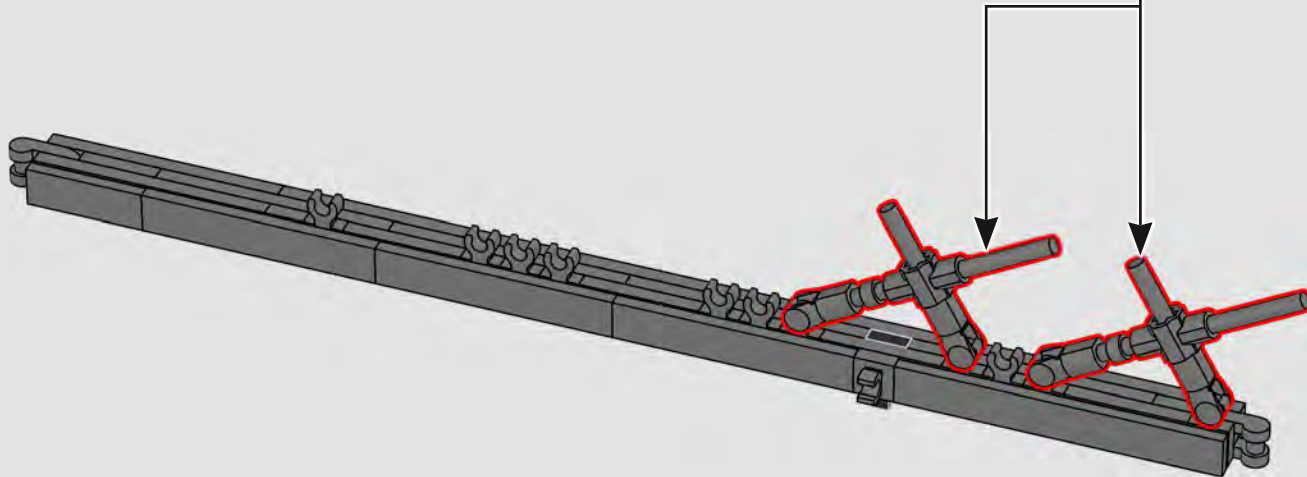
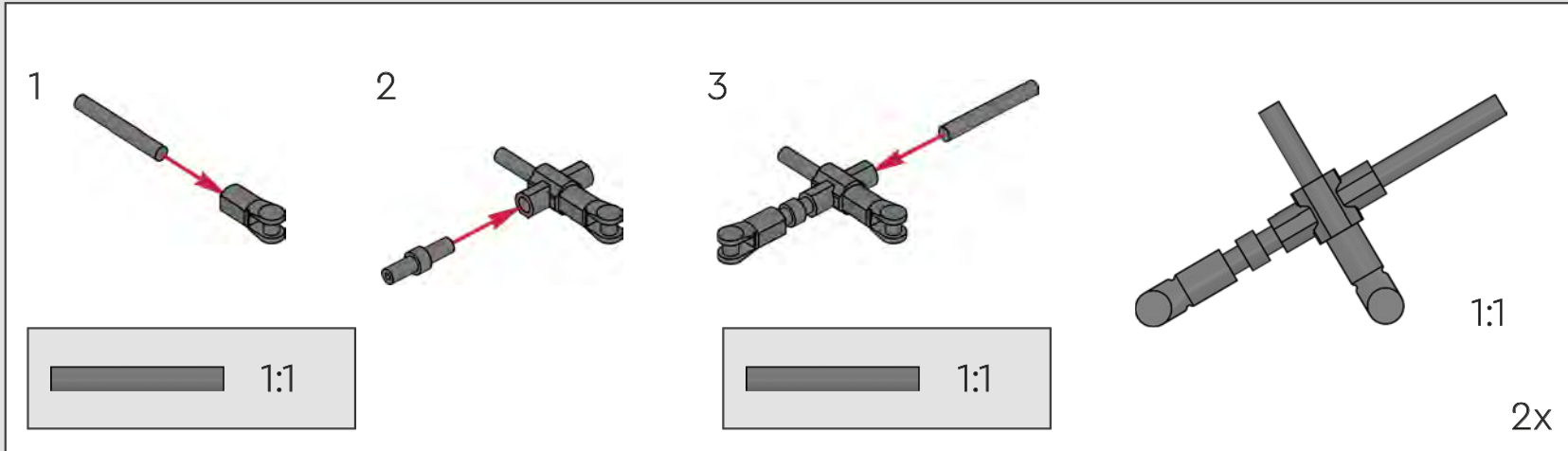

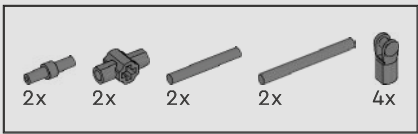

224

1 2 3 1:1 2x

1:1

1:1

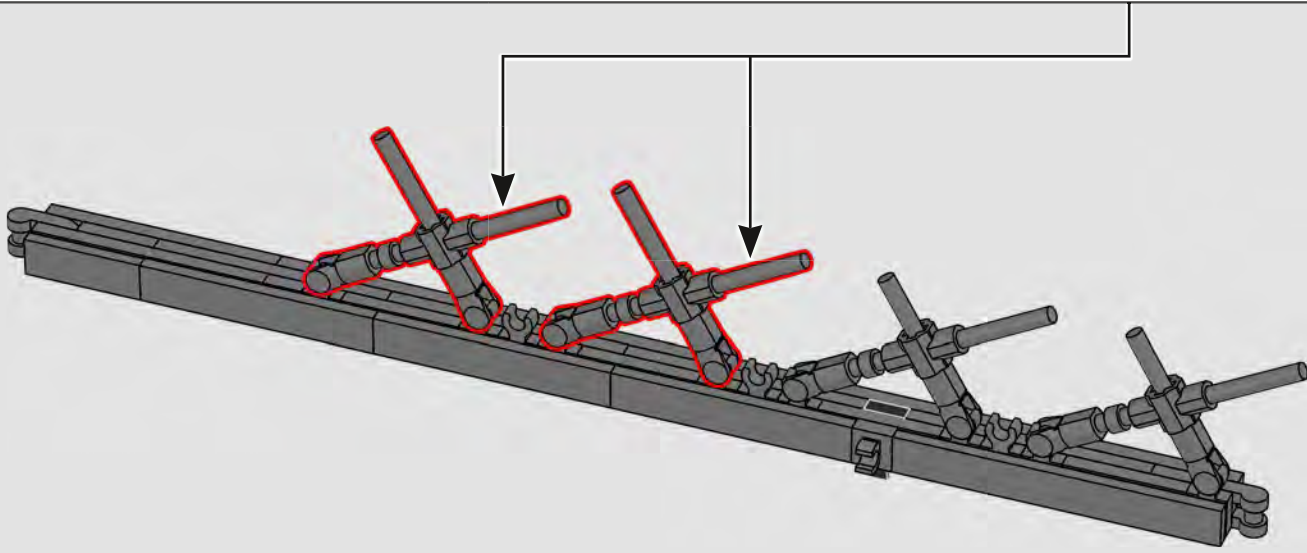

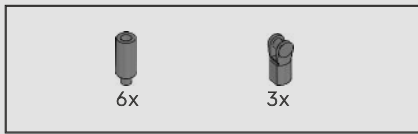

225

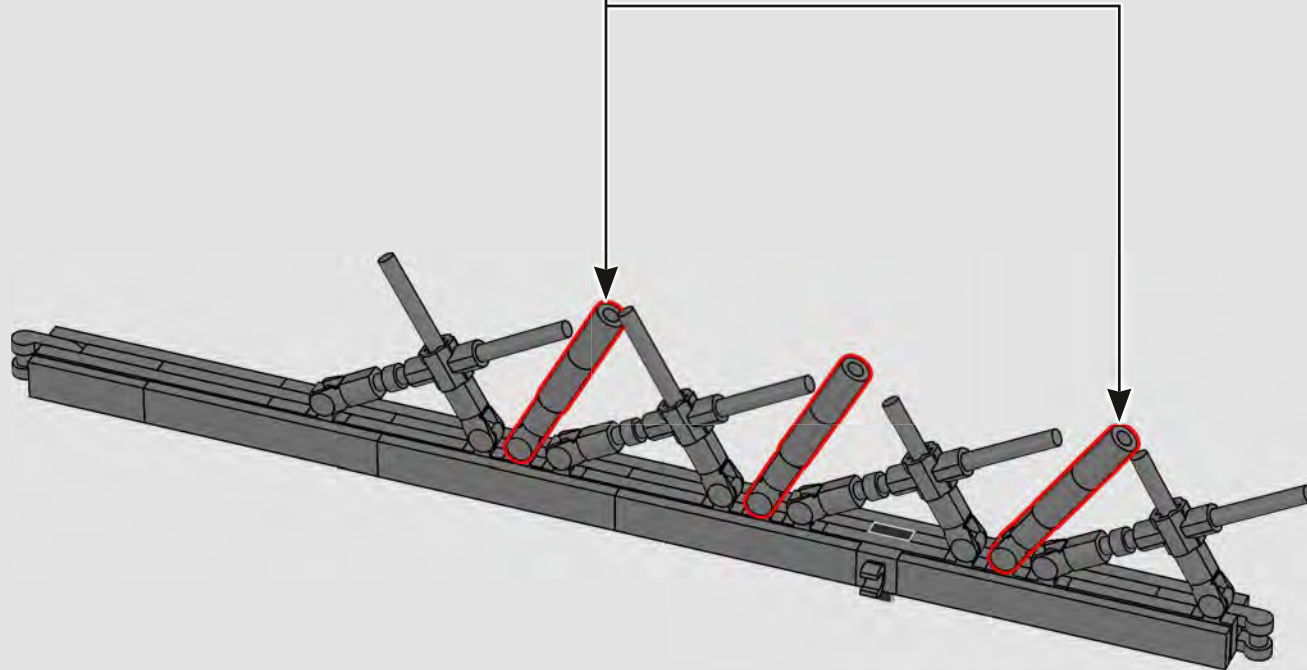
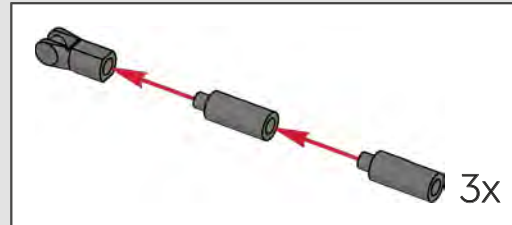

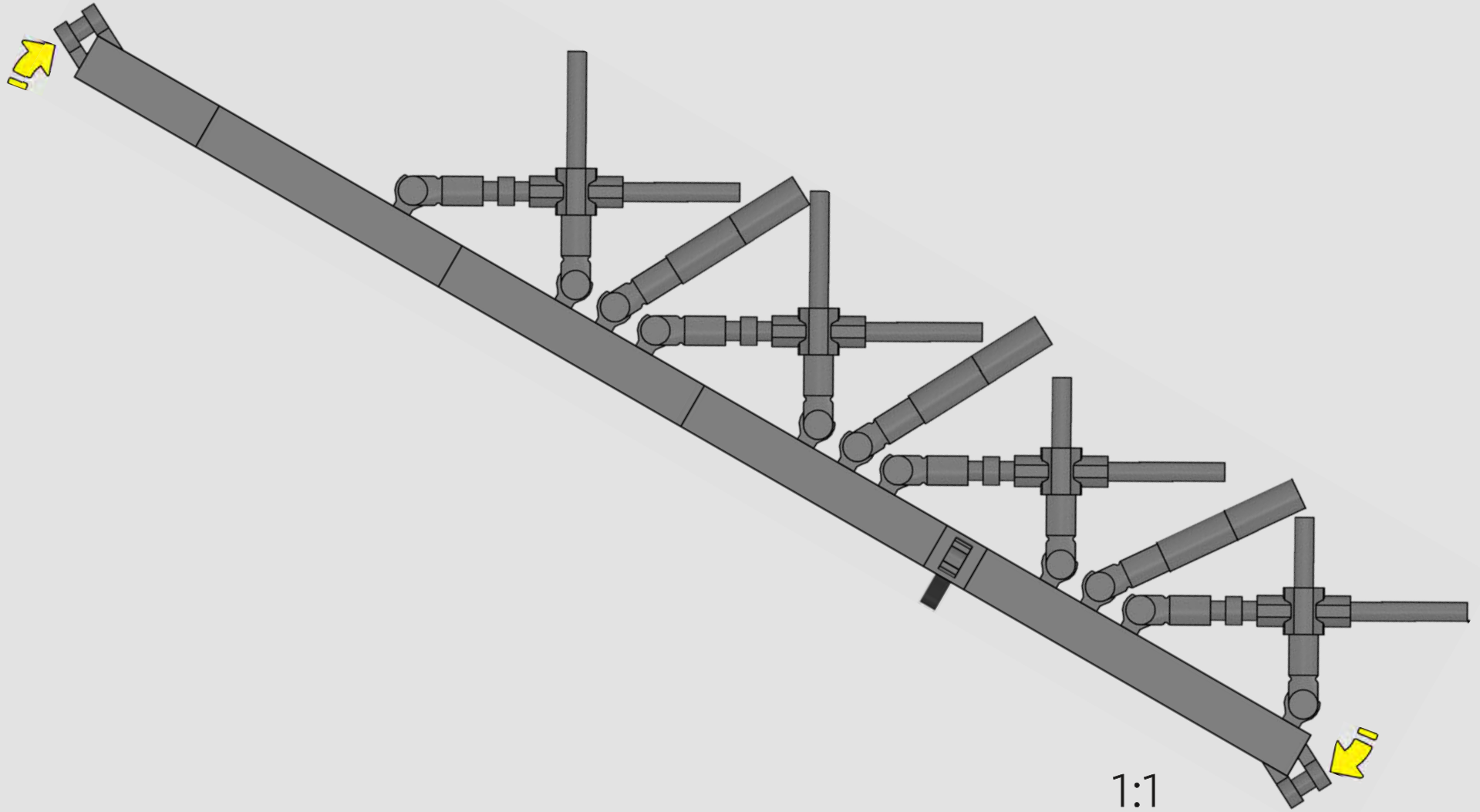

226

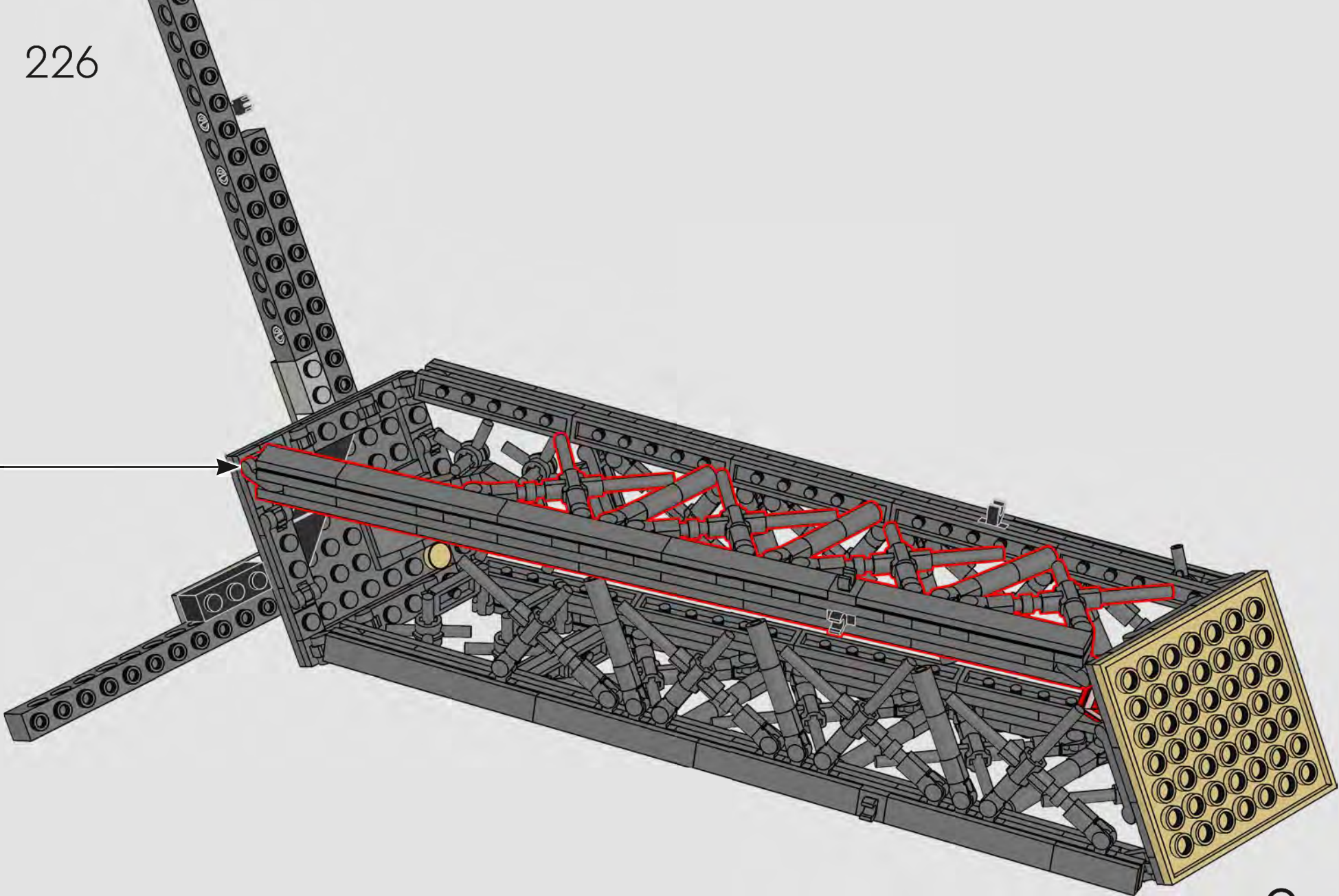

2x



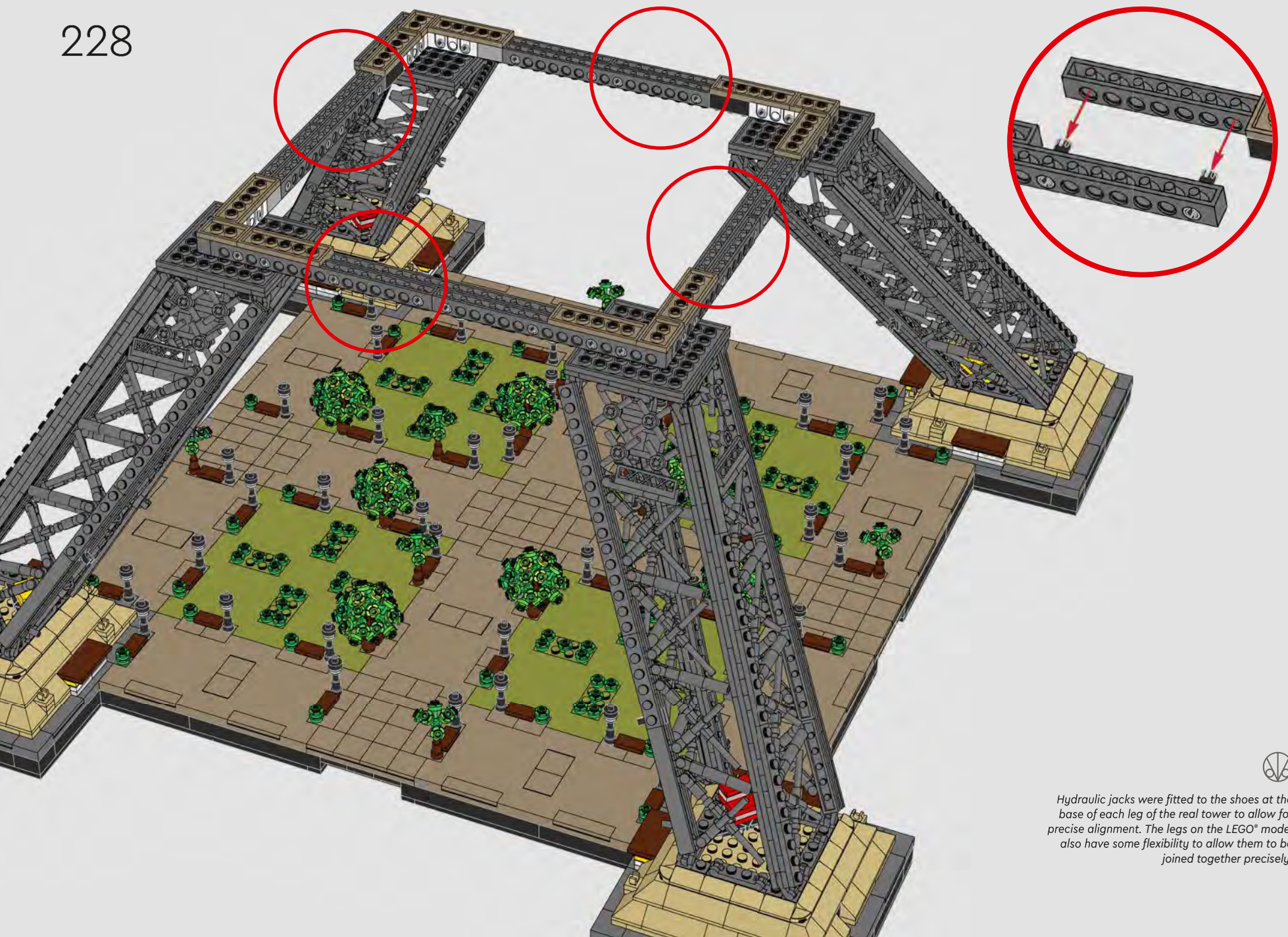

Hydraulic jacks were fitted to the shoes at the base of each leg of the real tower to allow for precise alignment. The legs on the LEGO® model also have some flexibility to allow them to be joined together precisely.

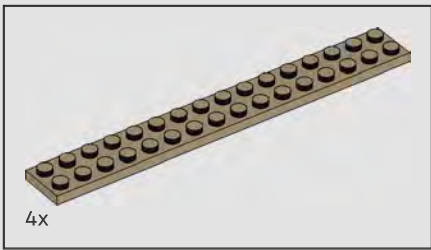

229



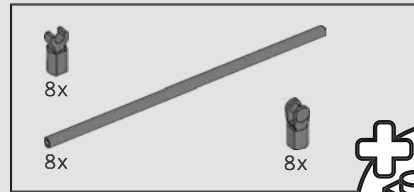
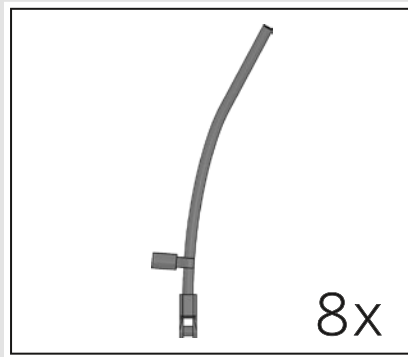
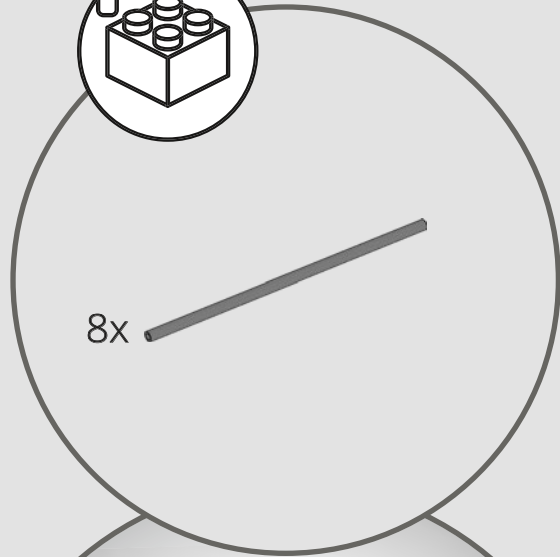
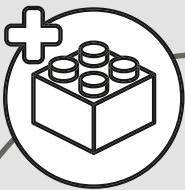

230

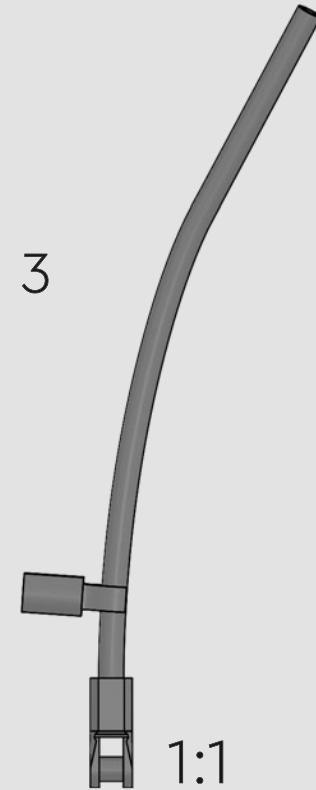

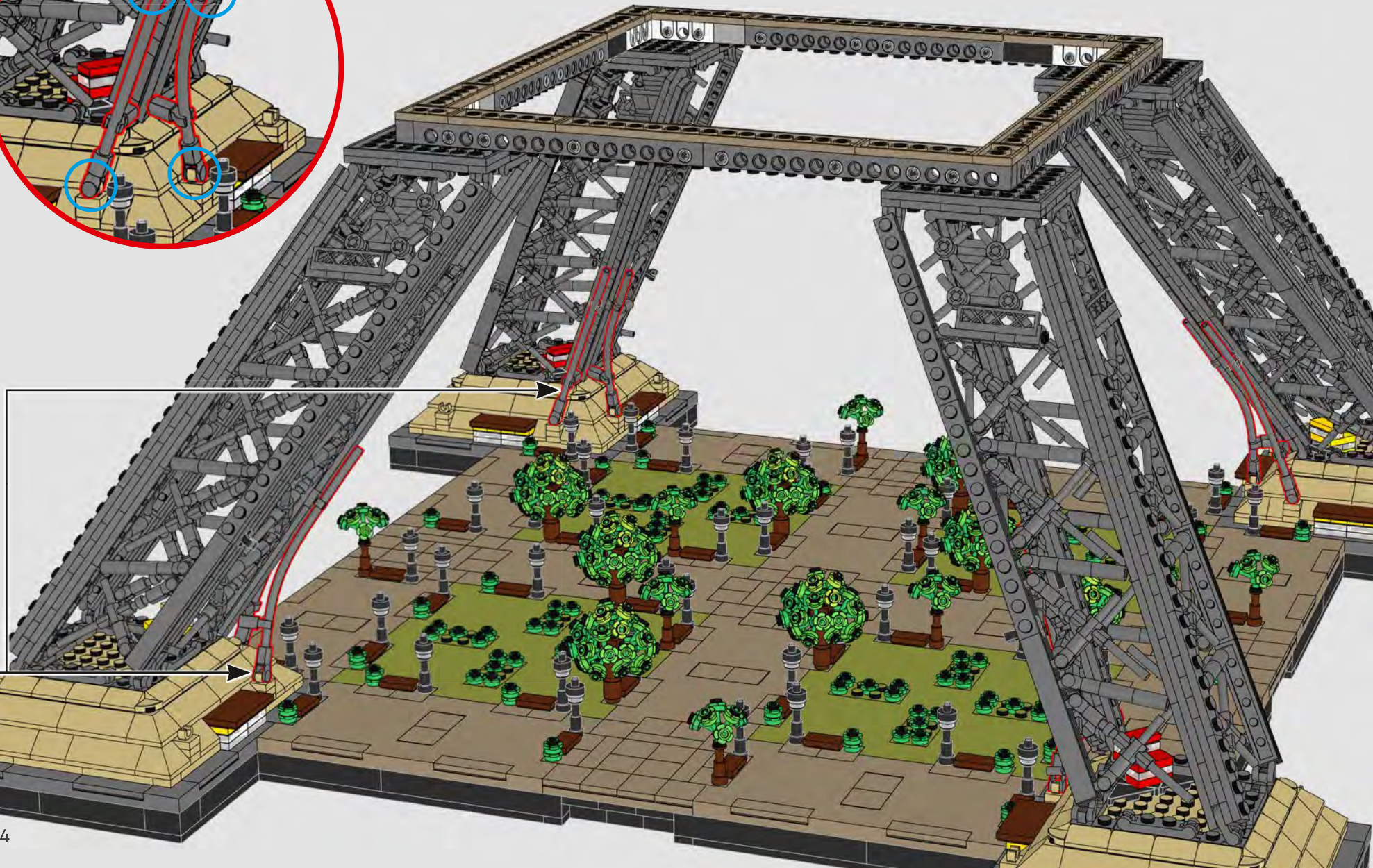
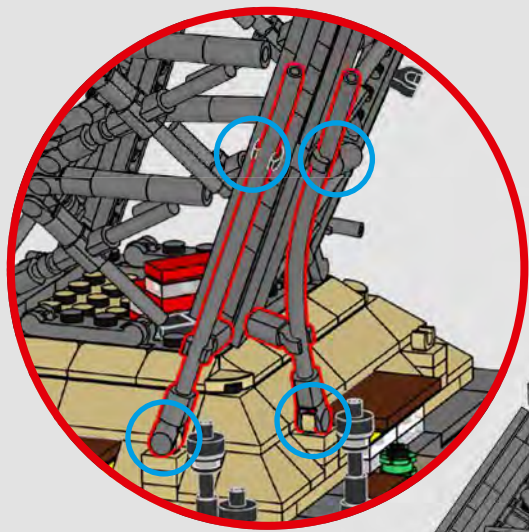

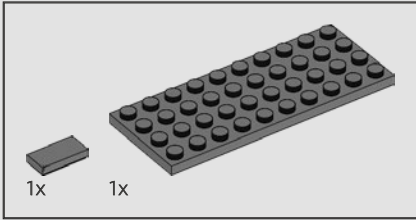
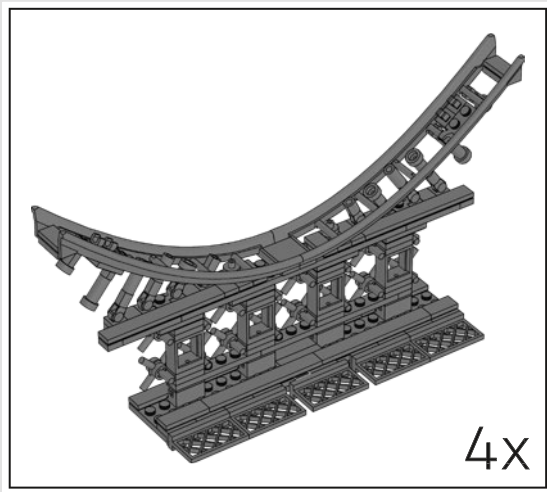

231

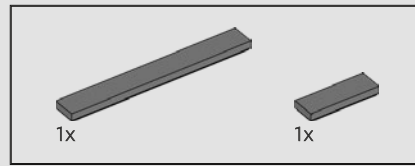
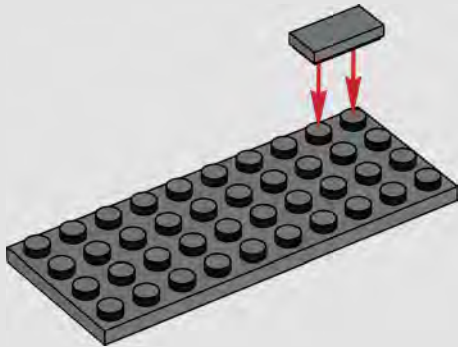

232

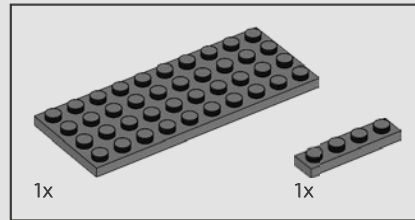
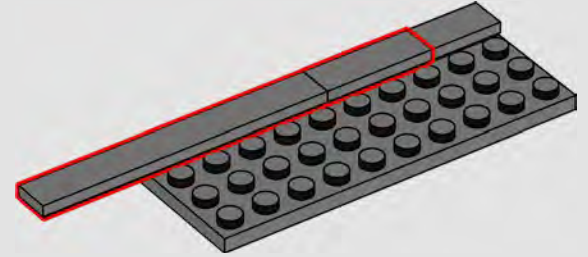

233

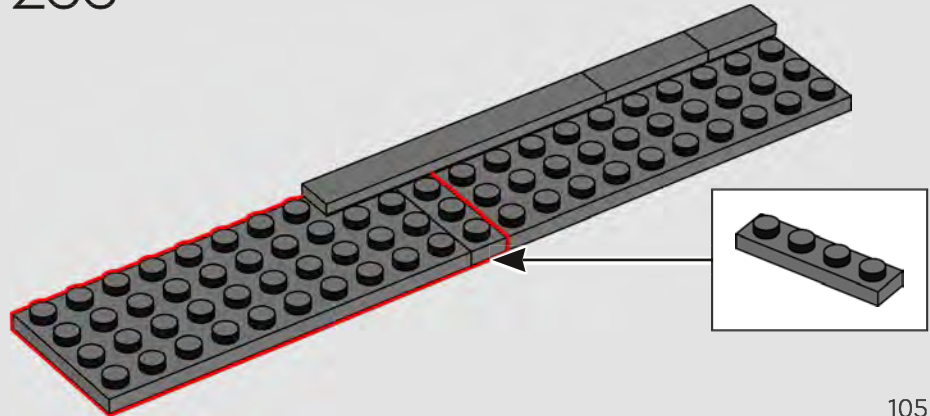

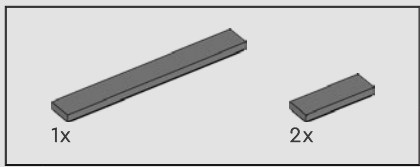

234

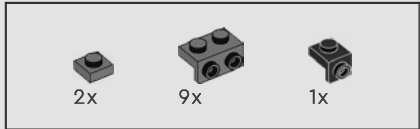
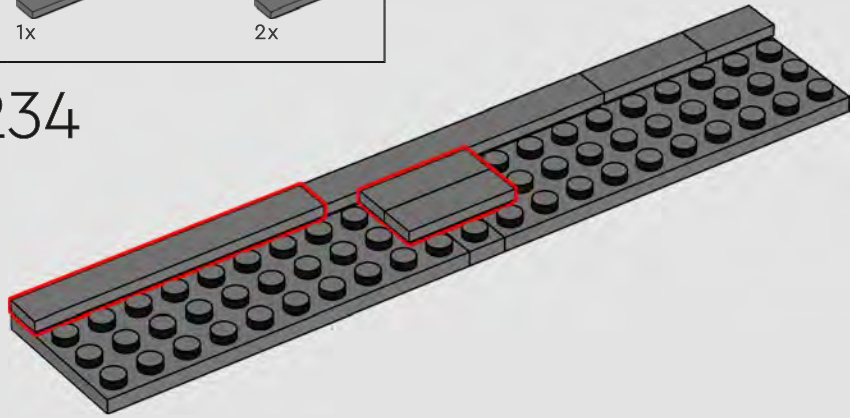

235

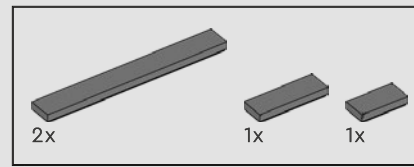
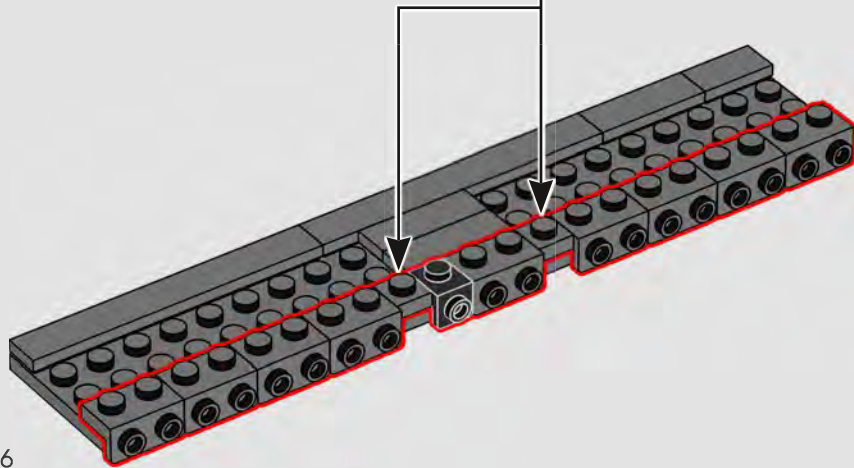

236

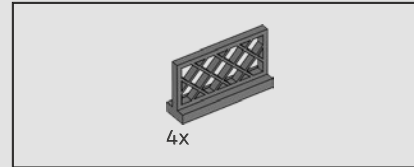
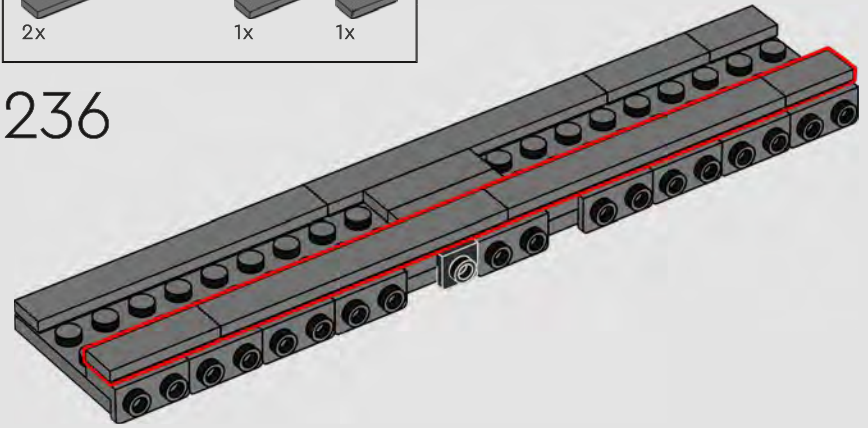

237

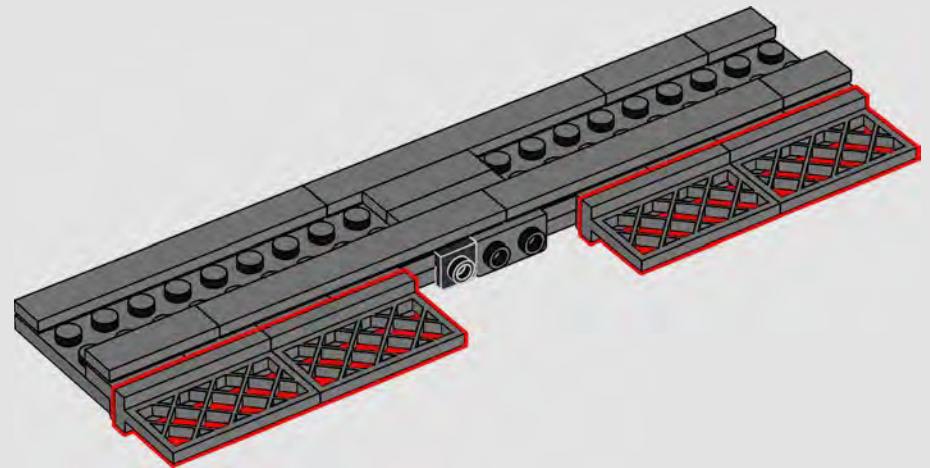

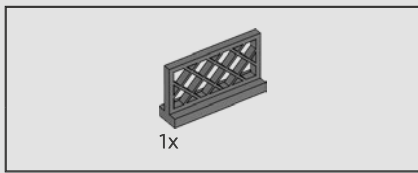

238

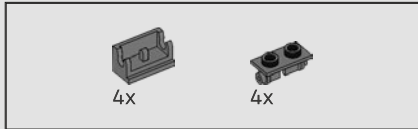
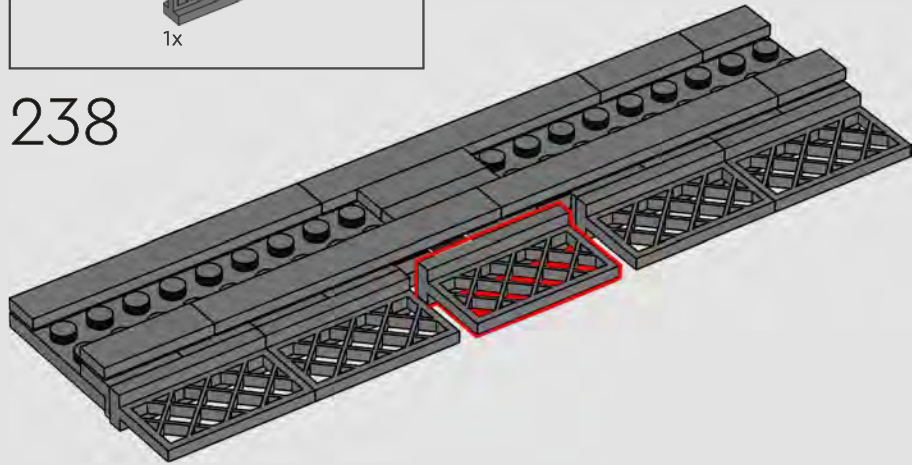

239

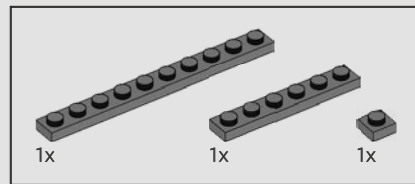
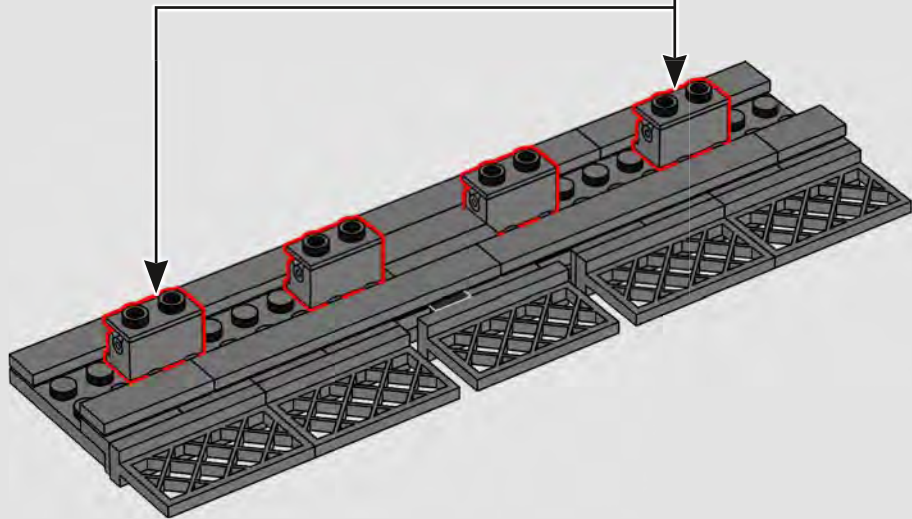
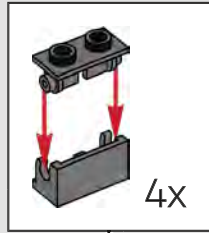

240

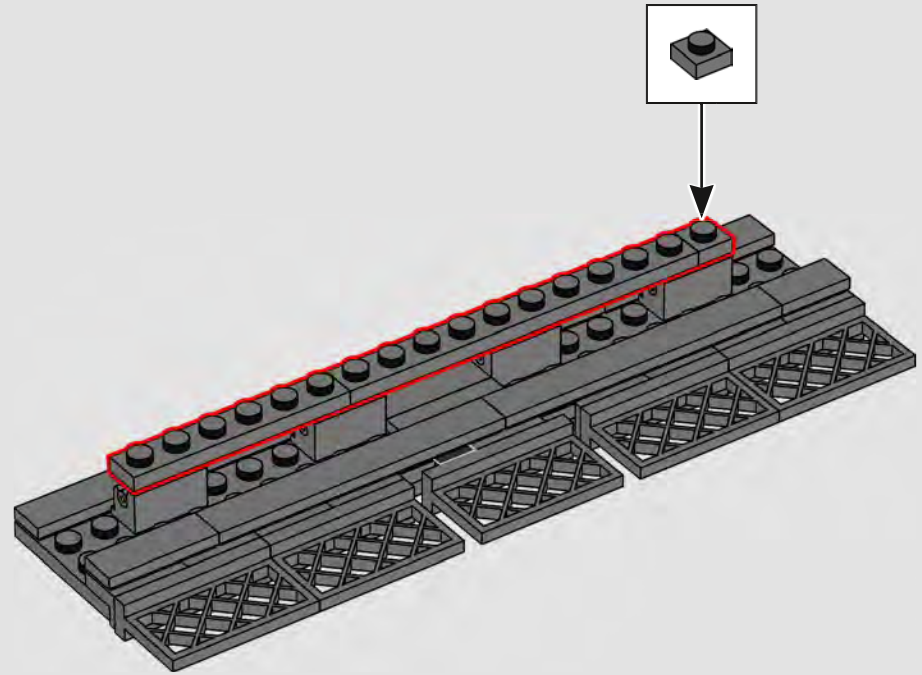



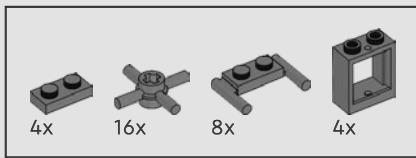

241

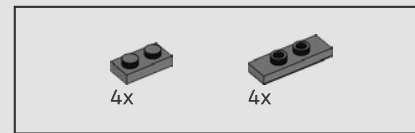
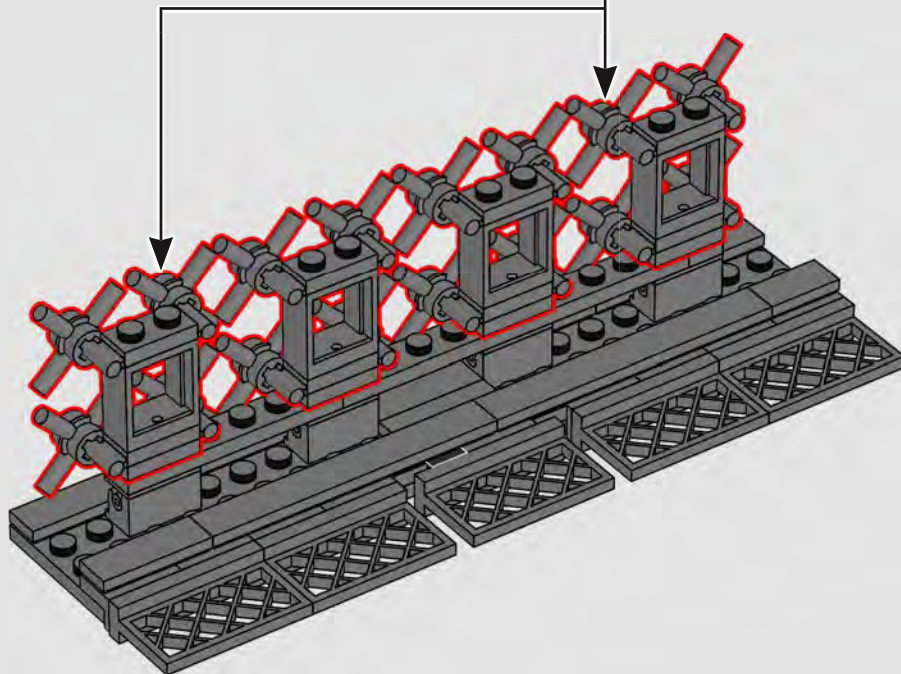
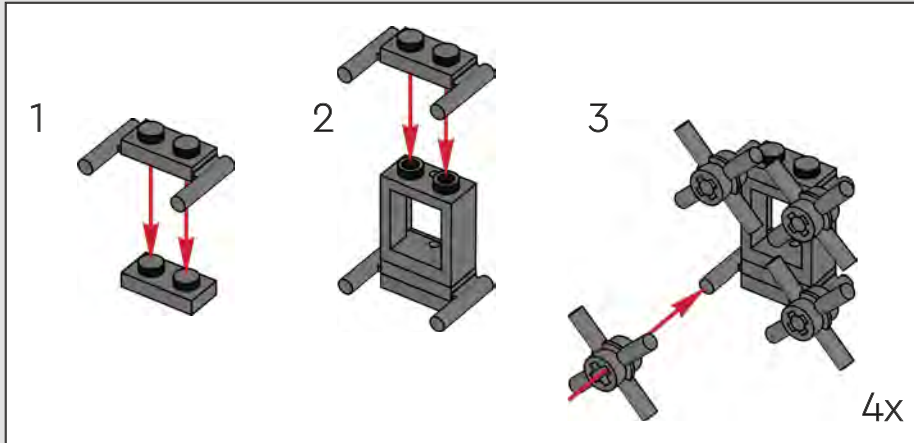

242

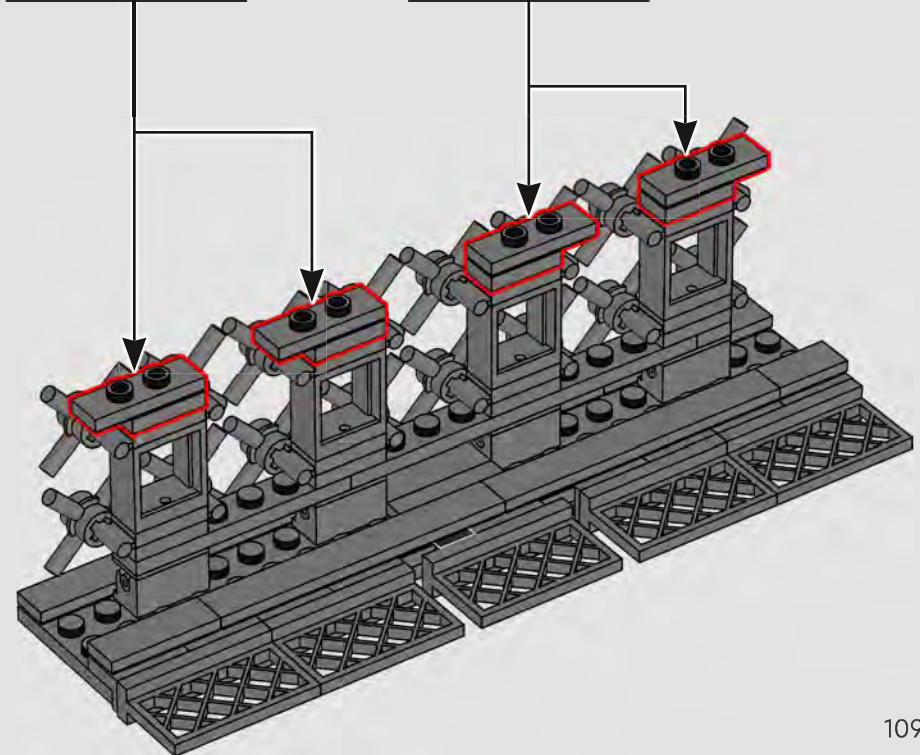
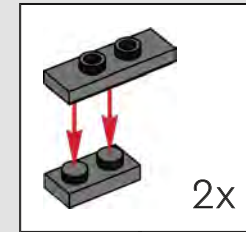
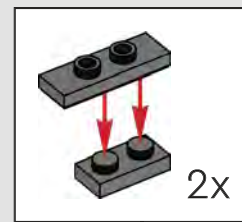

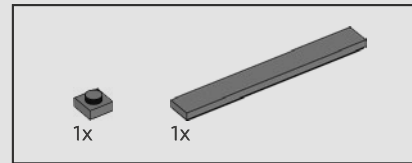
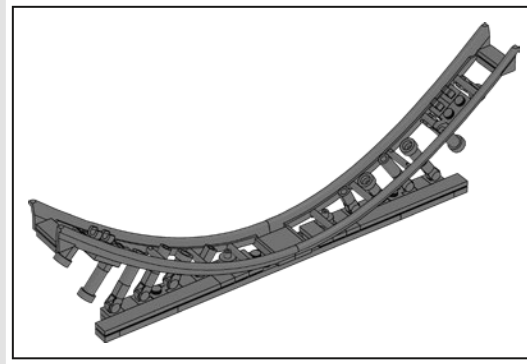
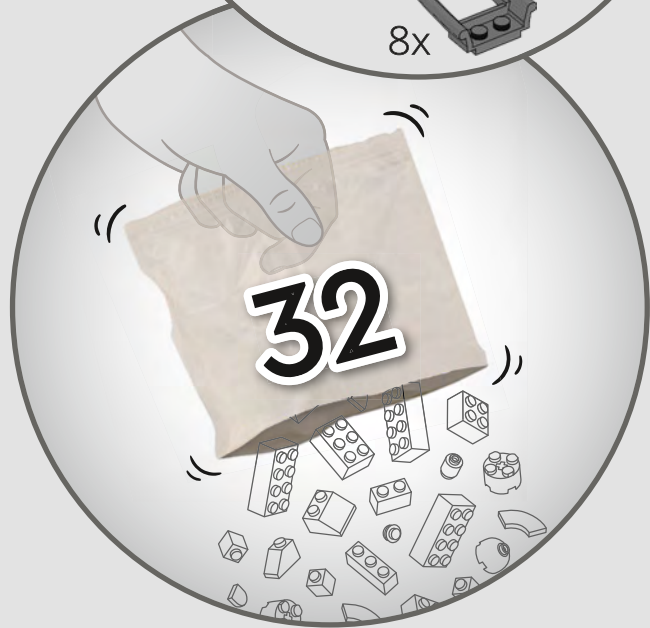
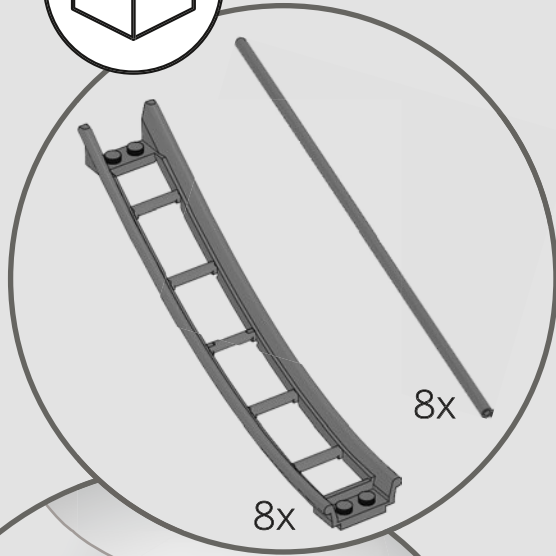

243

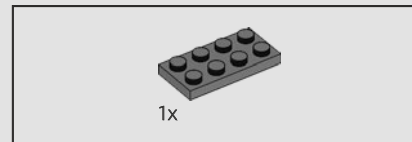
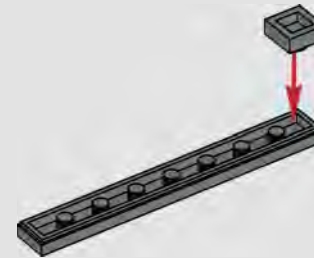

244

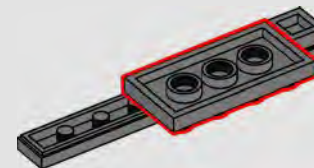

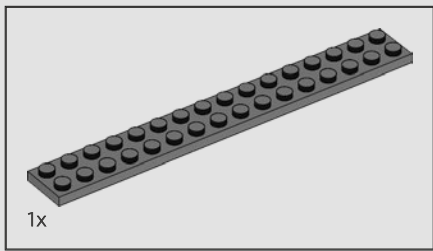

245

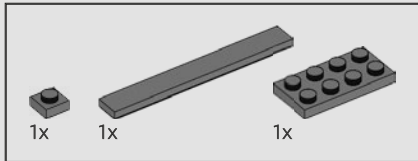
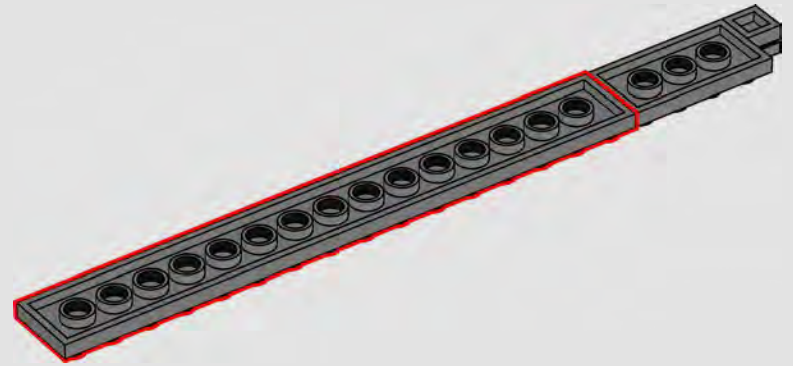

246

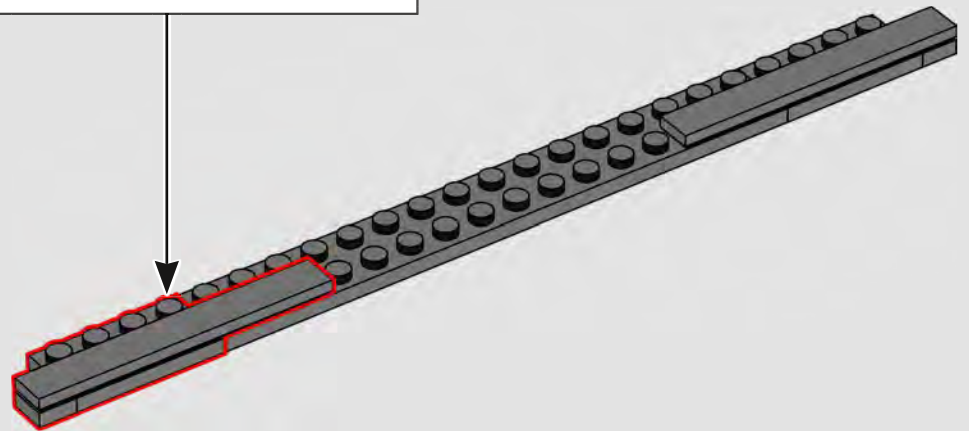
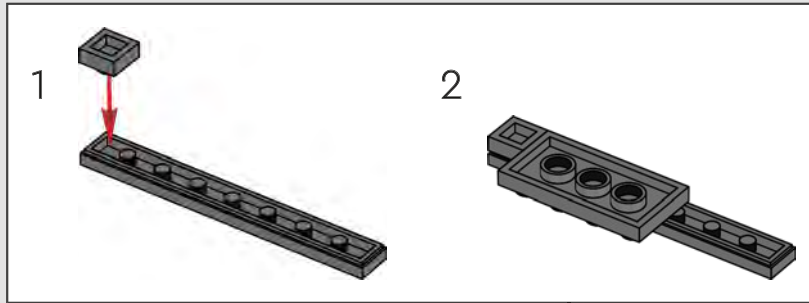

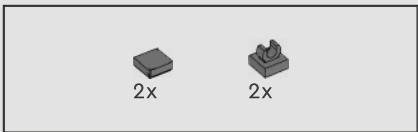

247

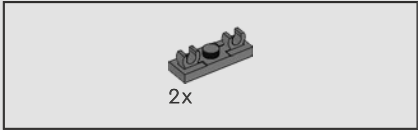
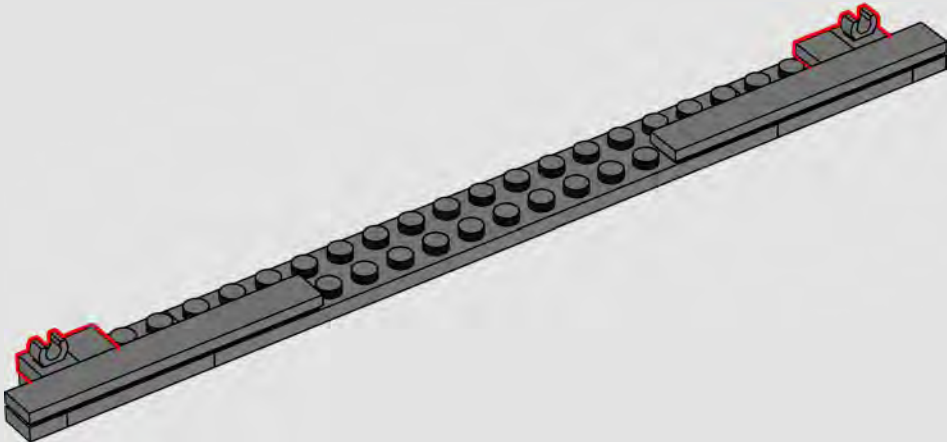

248

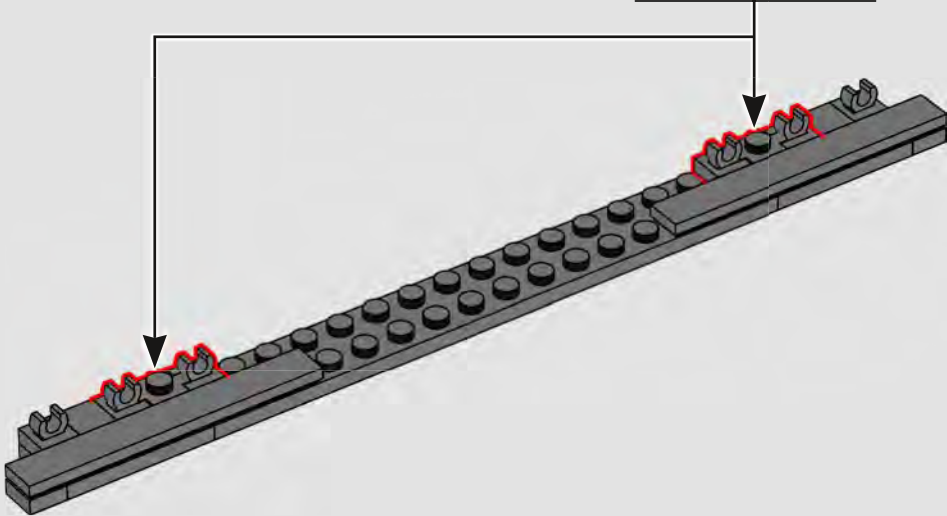
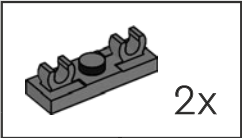

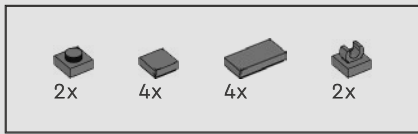

249

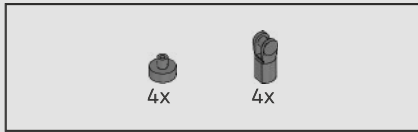
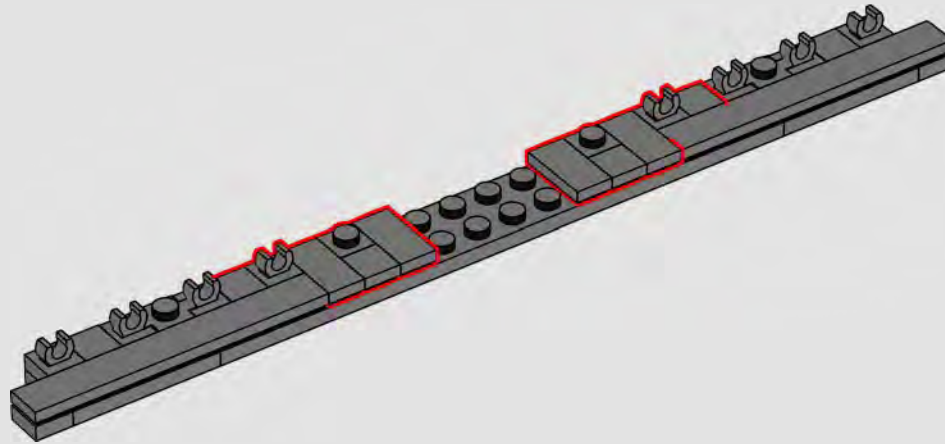

250

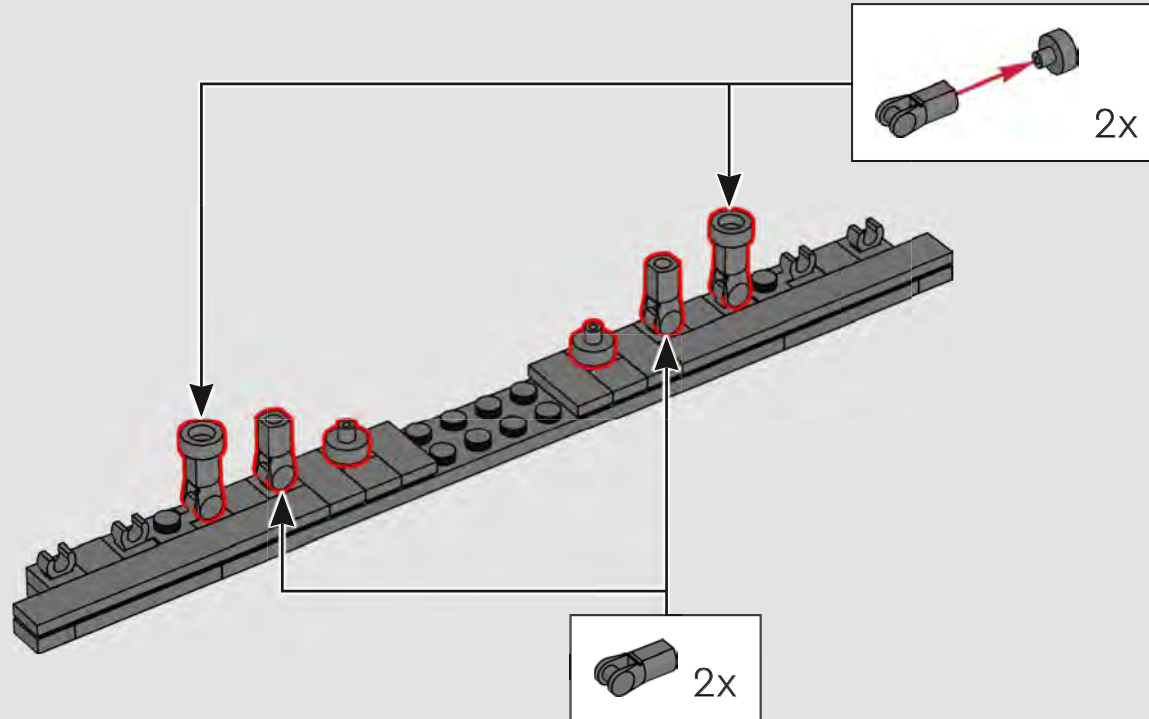

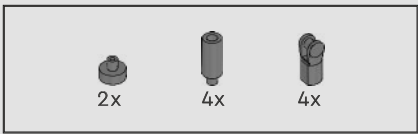

251

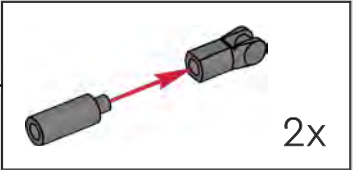
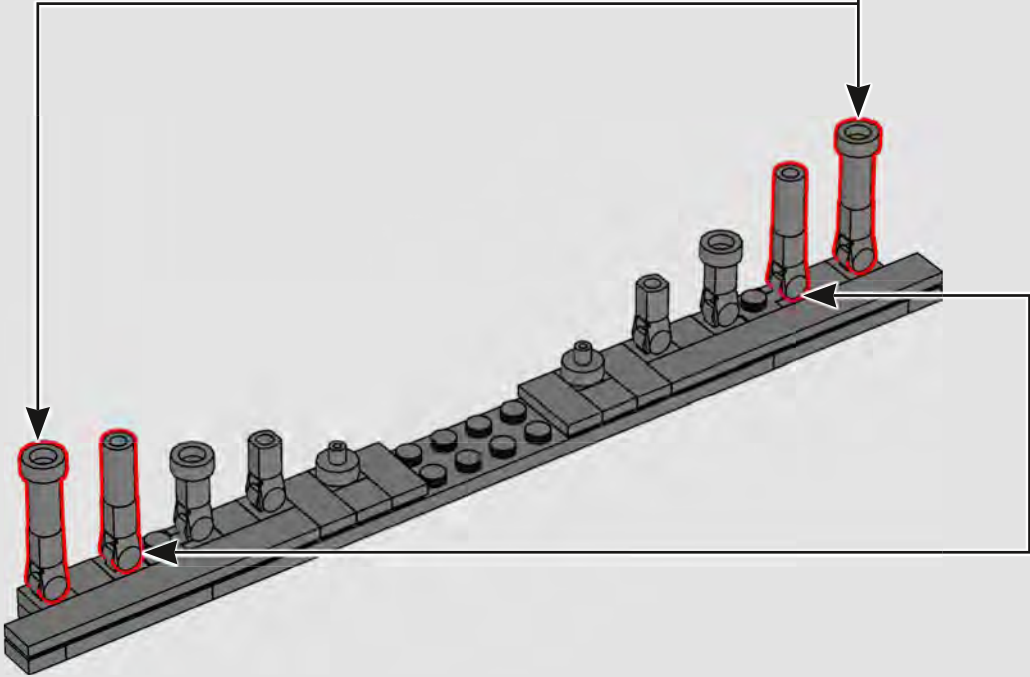
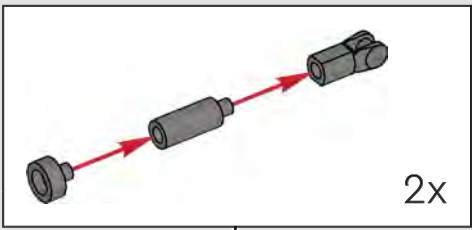

252

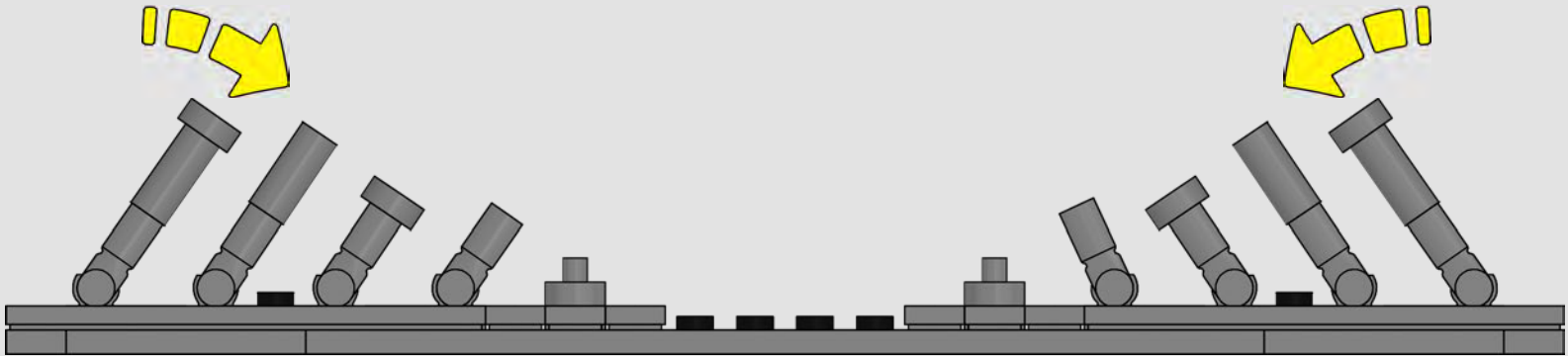



The arches in between the tower's legs are recreated using LEGO® rollercoaster tracks, and the curves are completed using LEGO outer cables.

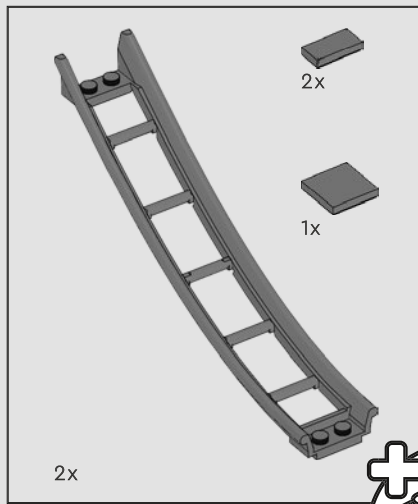

253

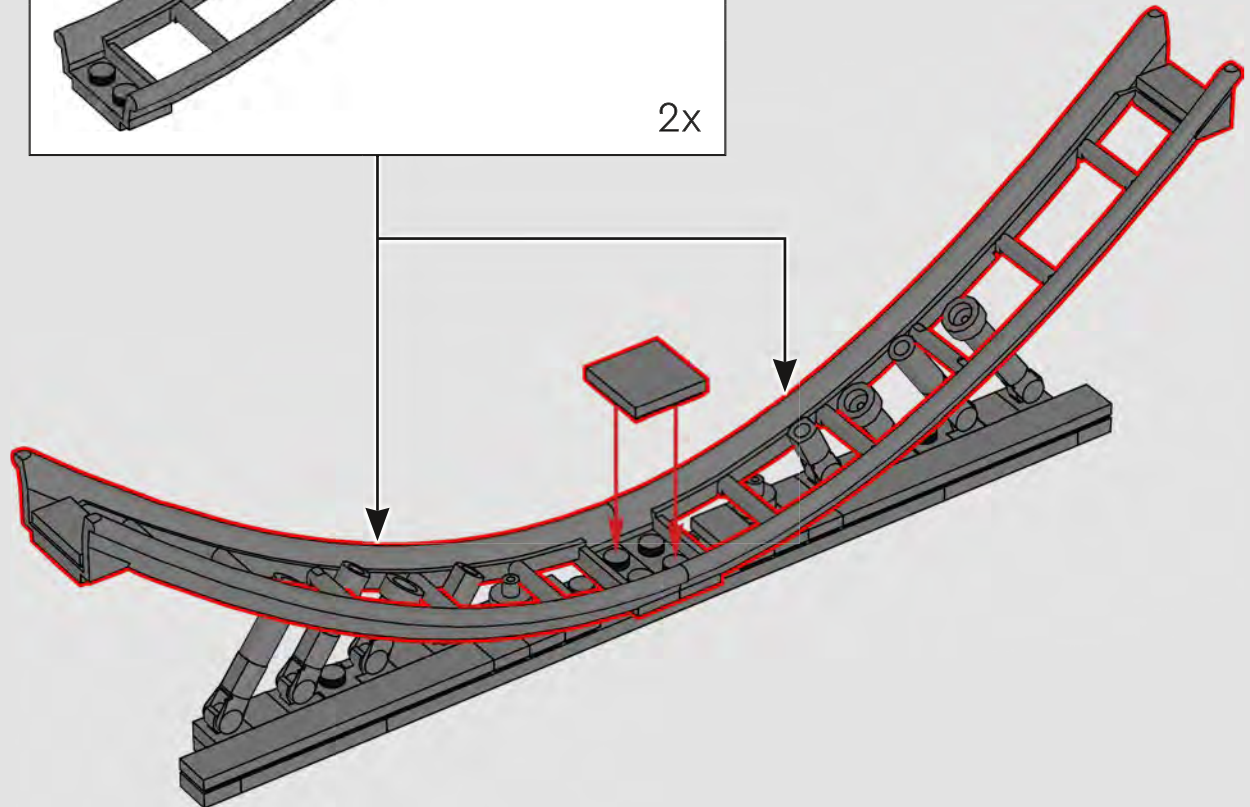
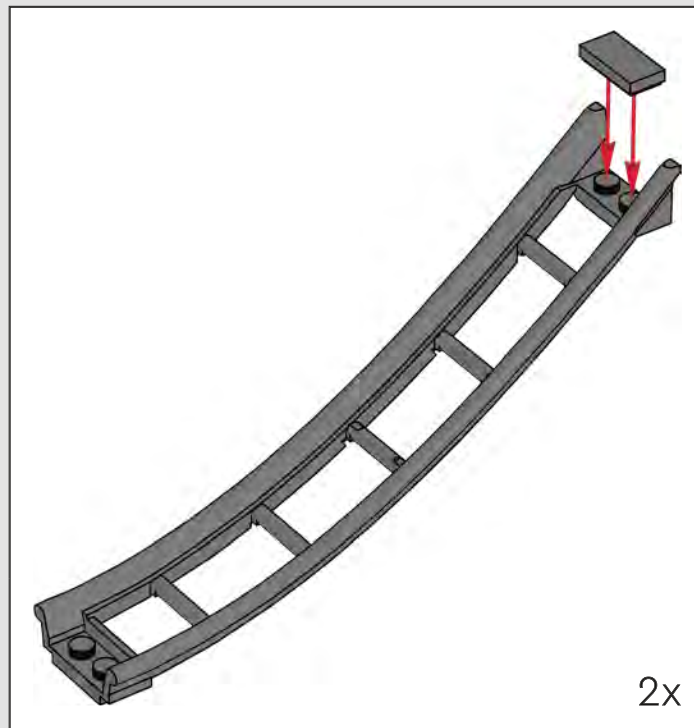
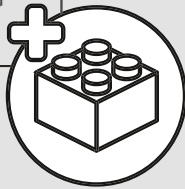



254

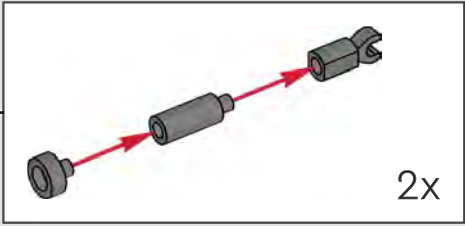
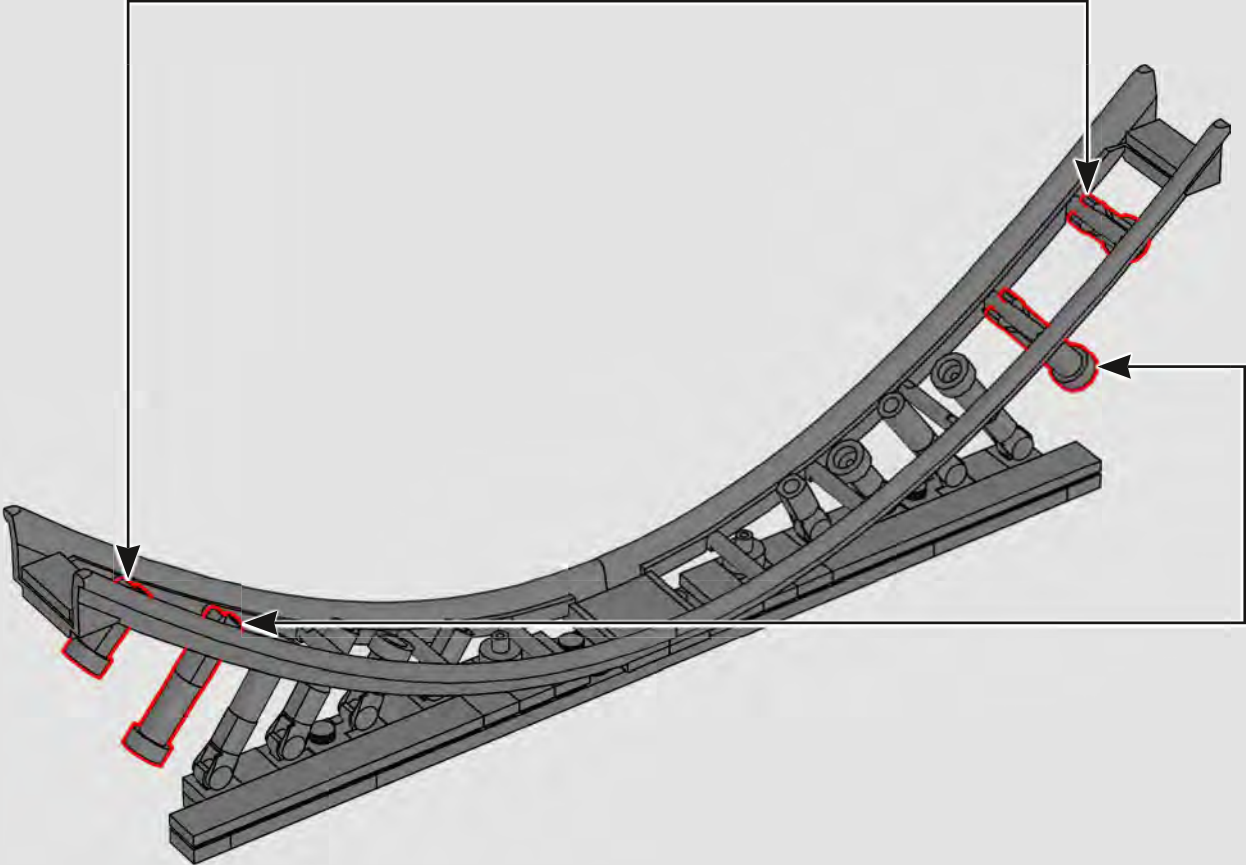
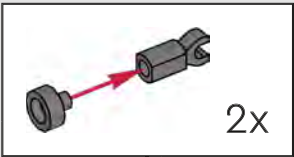

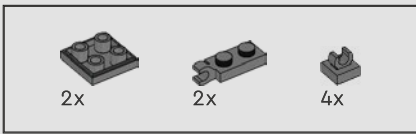

255

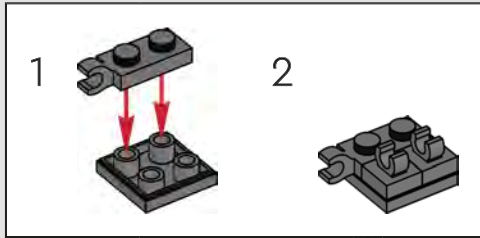

2

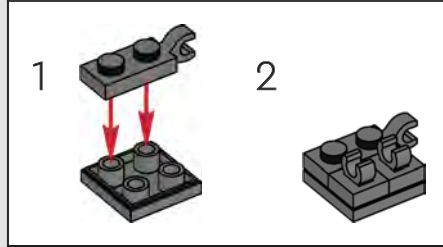
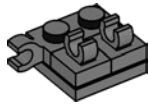

2

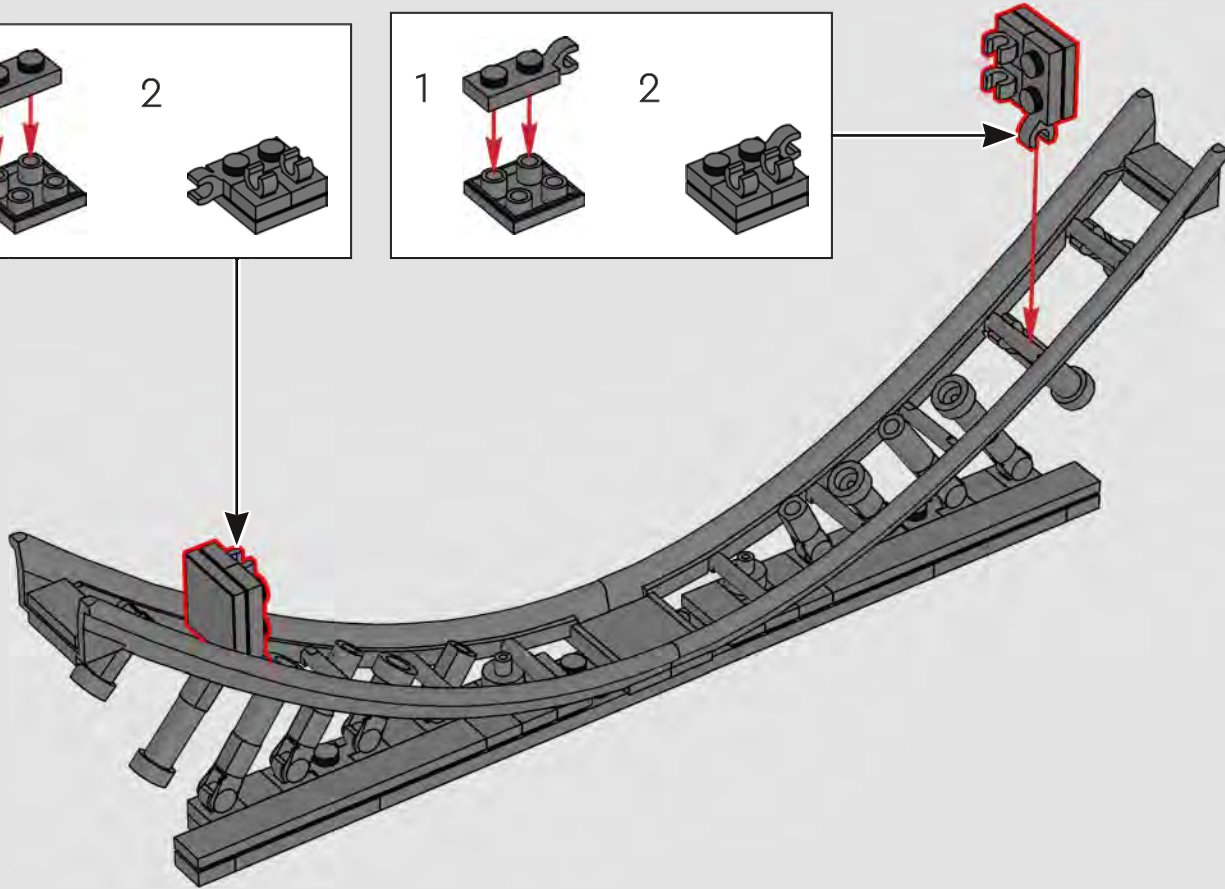
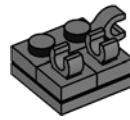

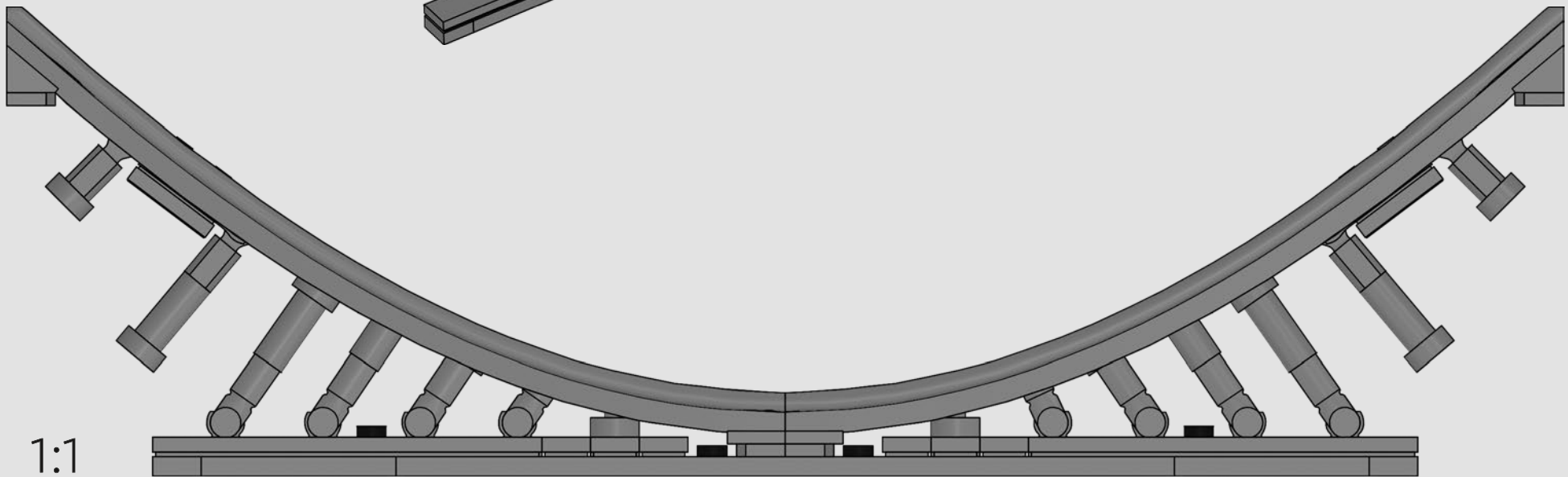
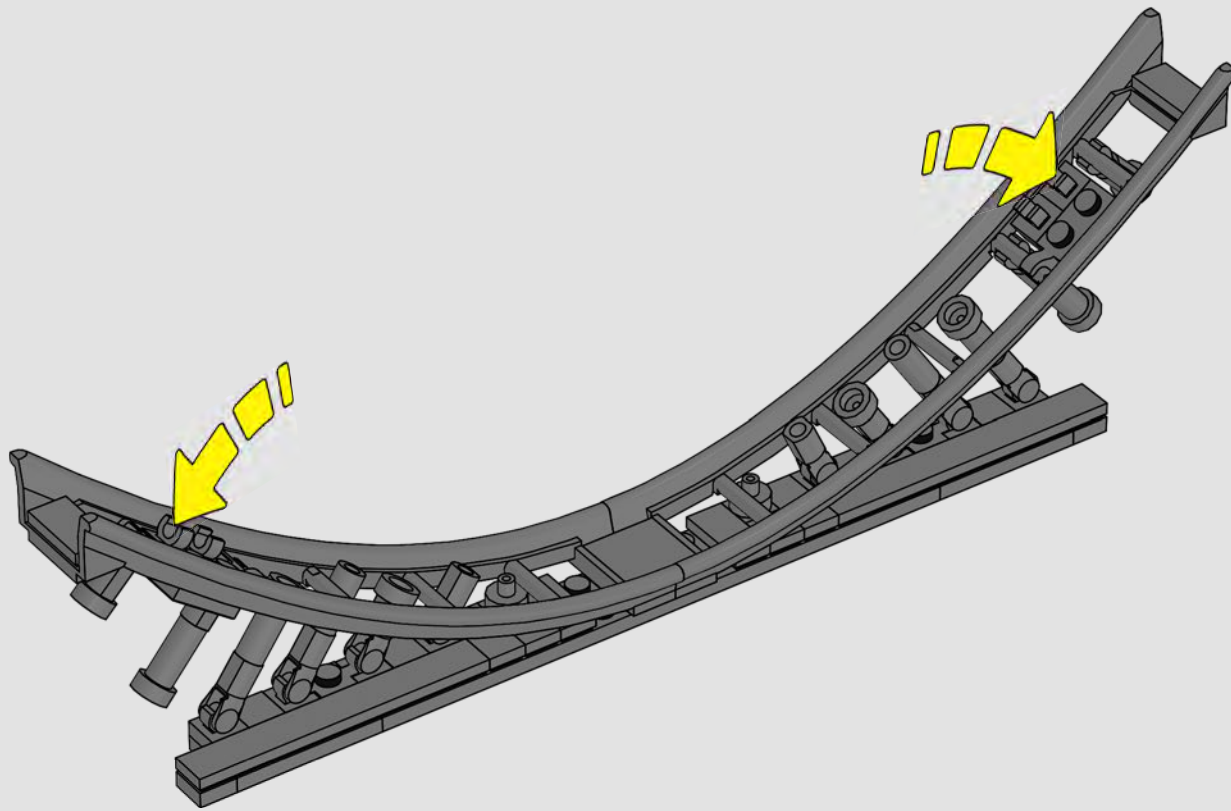

1:1

257

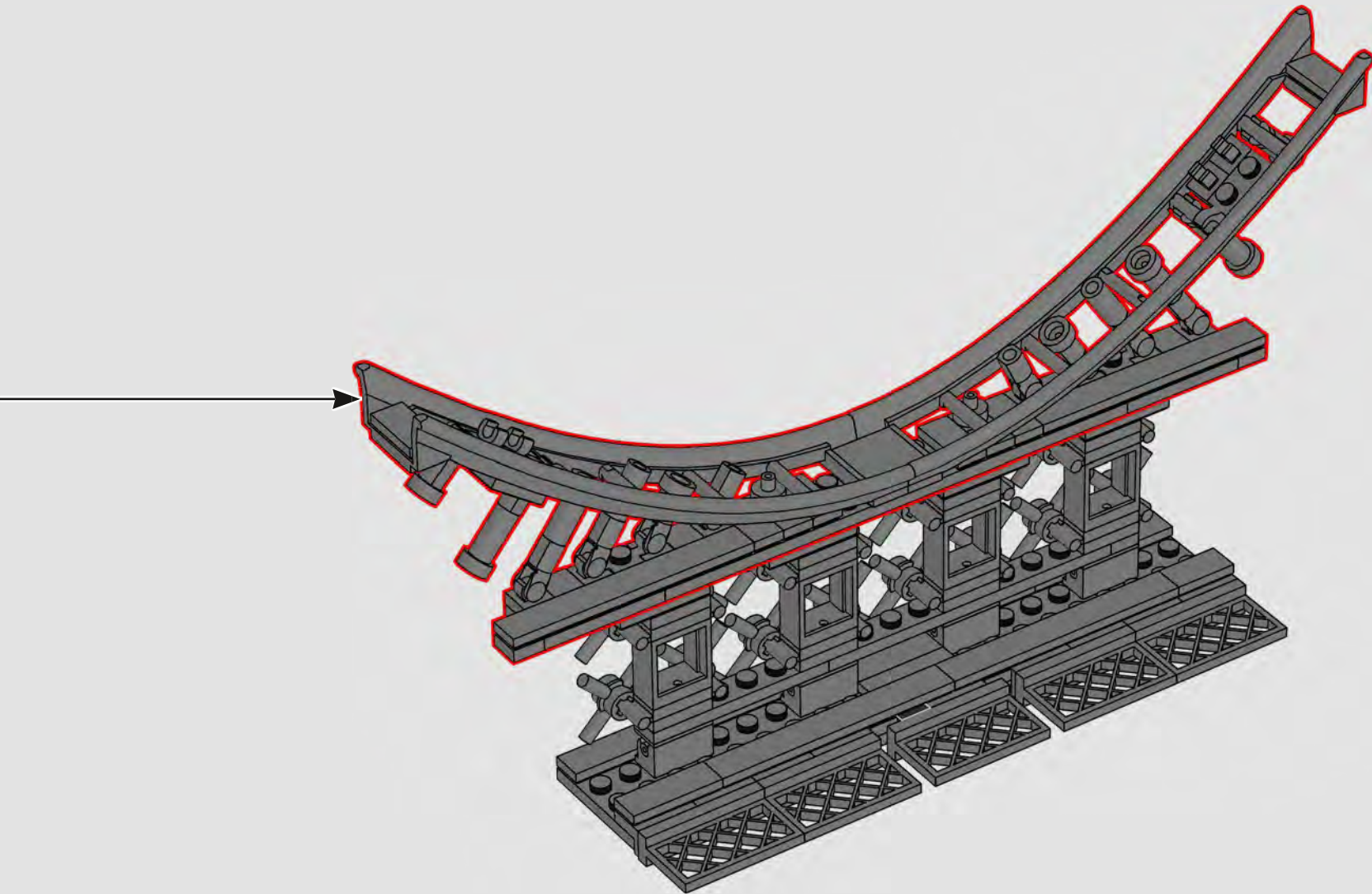

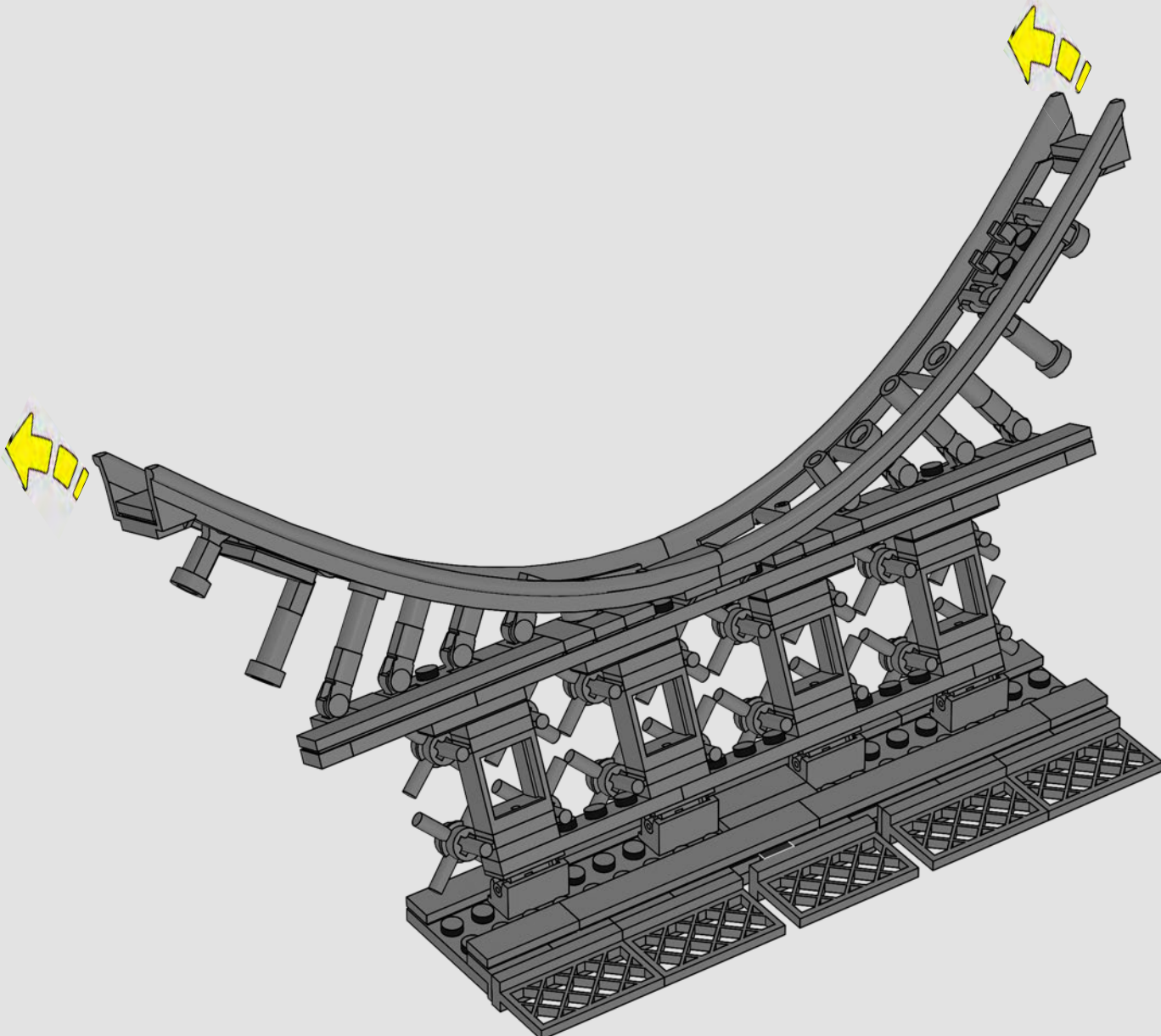

259



The arches between the legs on the Eiffel tower are not load bearing, they are purely decorative – this is also true of the LEGO® model, where the arches are also for decorative purposes only.

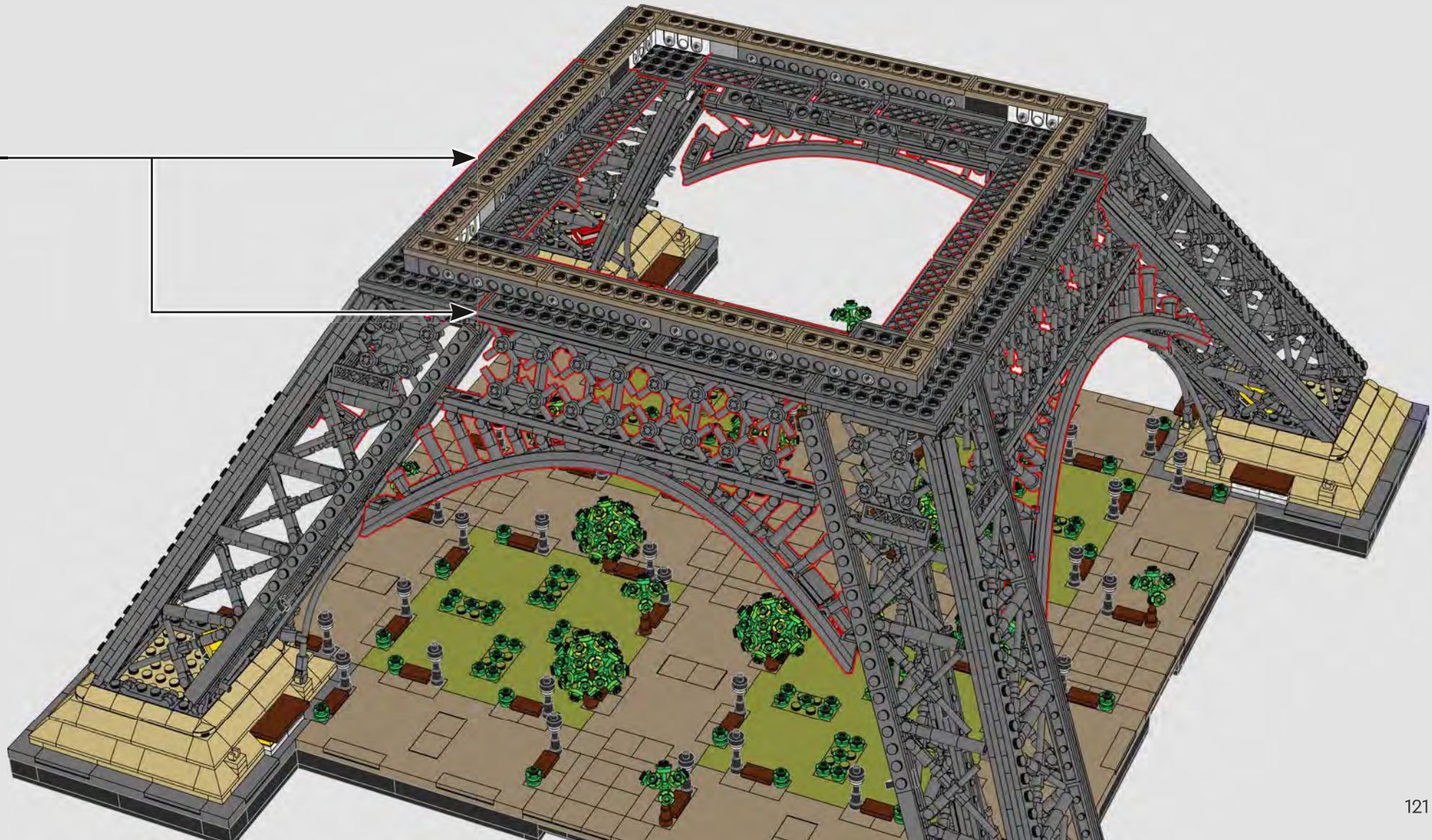

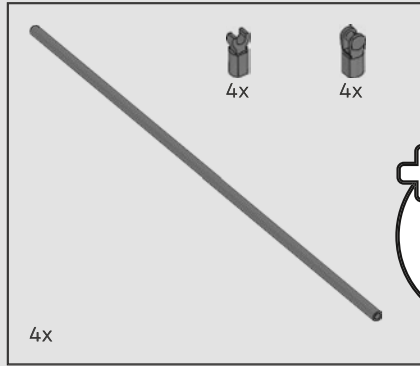
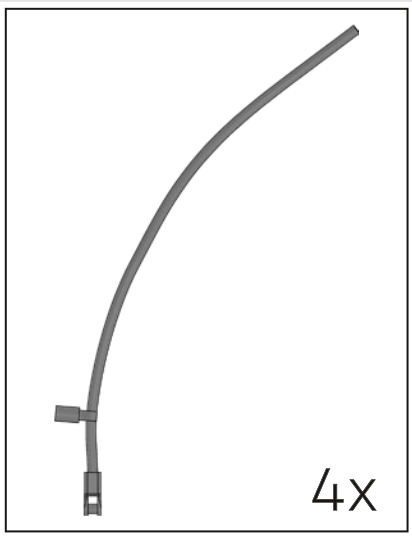

260

1



2



3

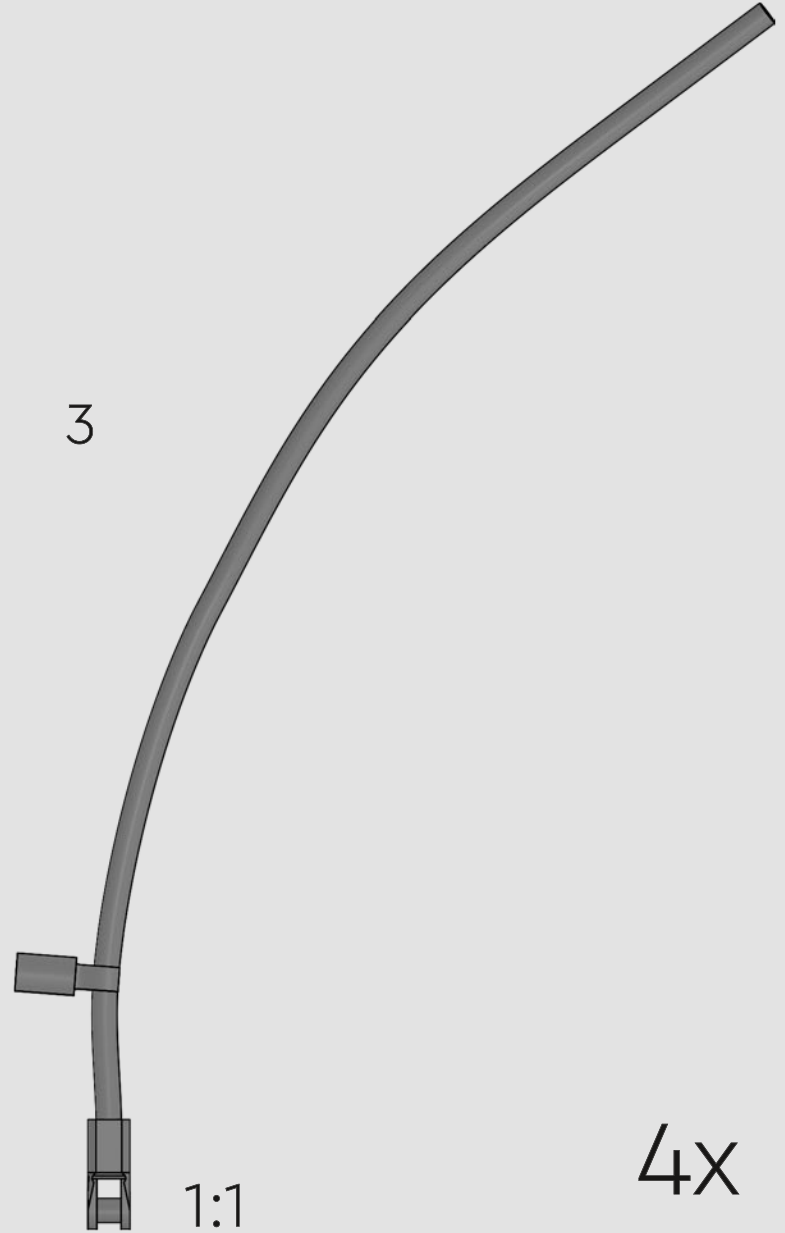



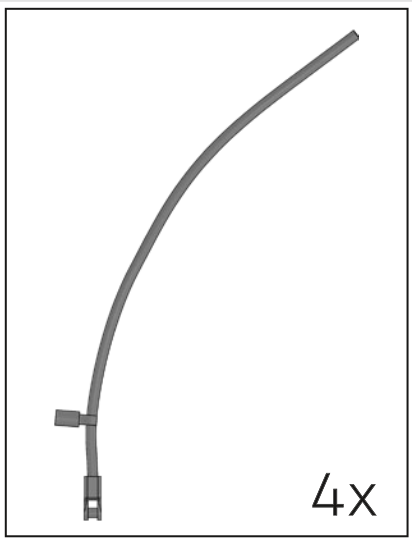

1



2



3

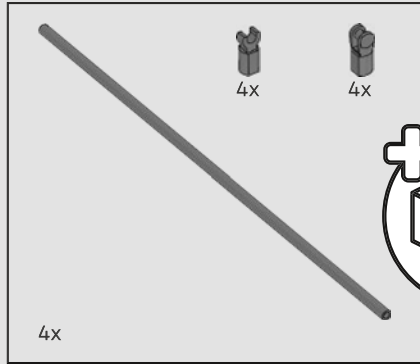
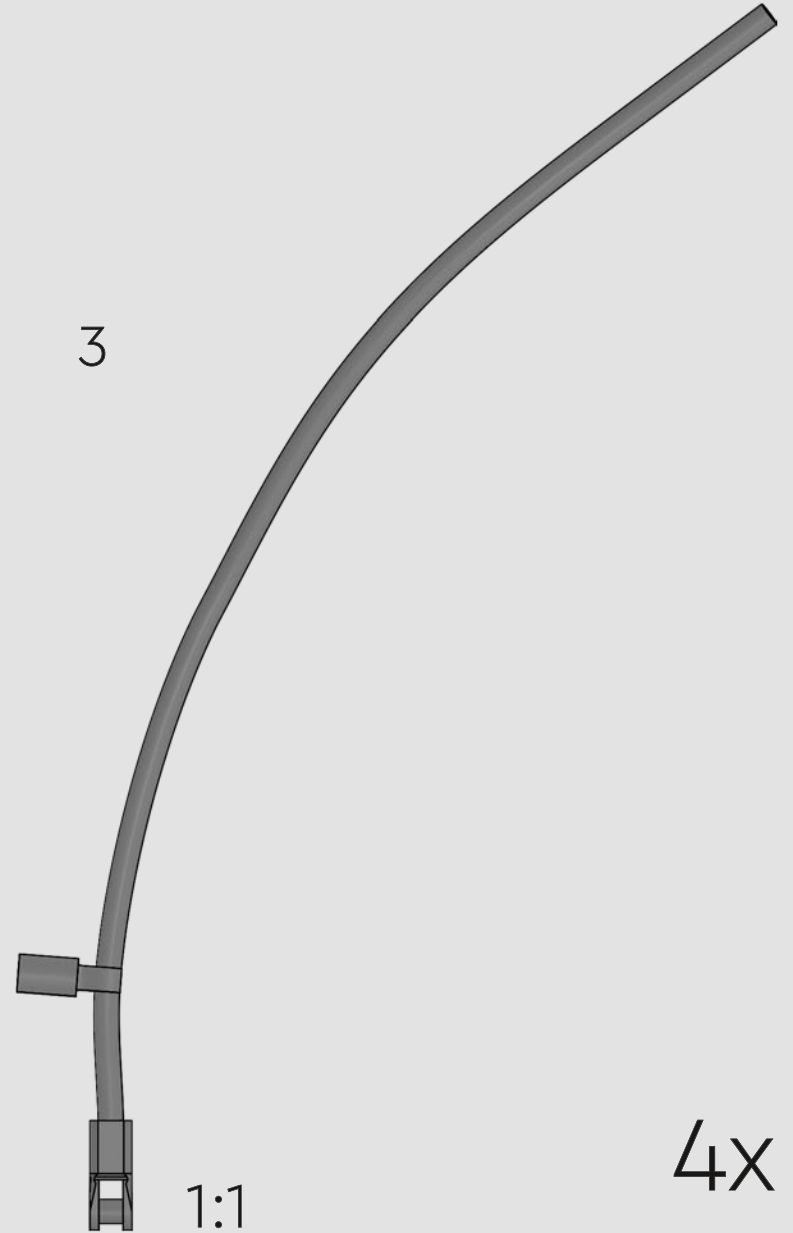

261

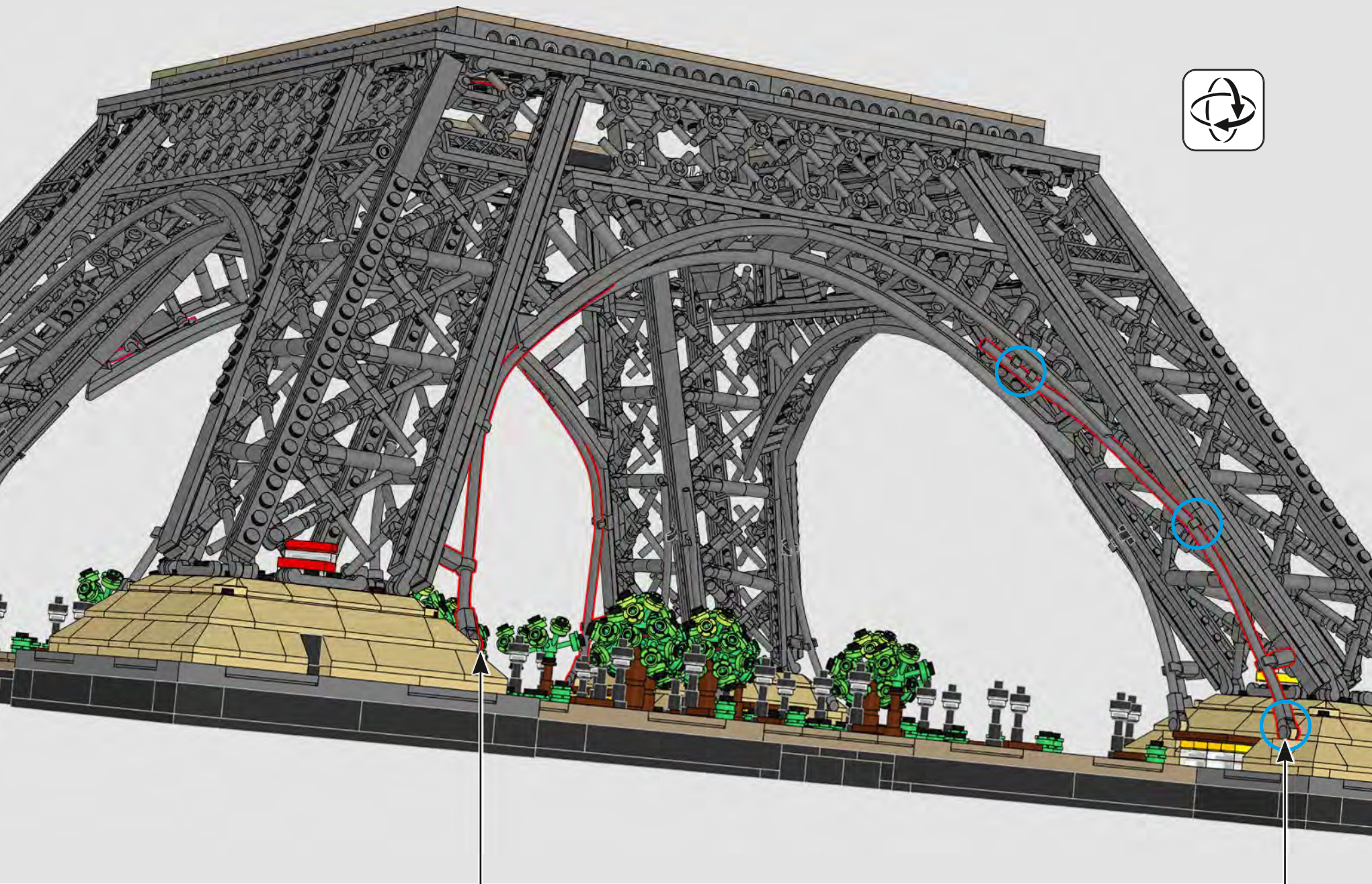

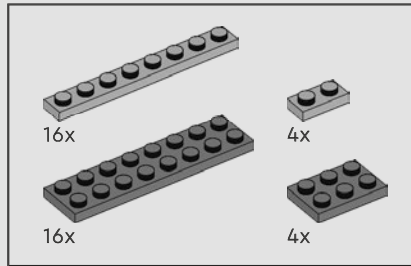
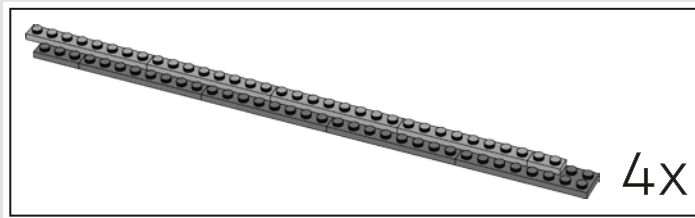

262

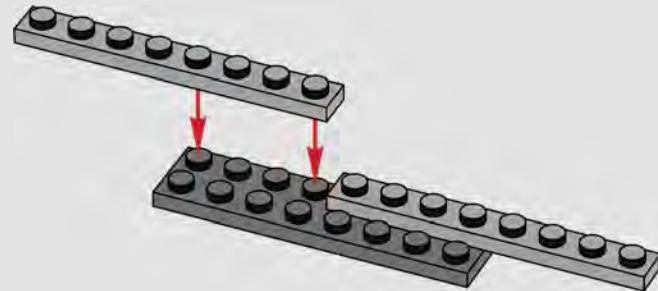

1

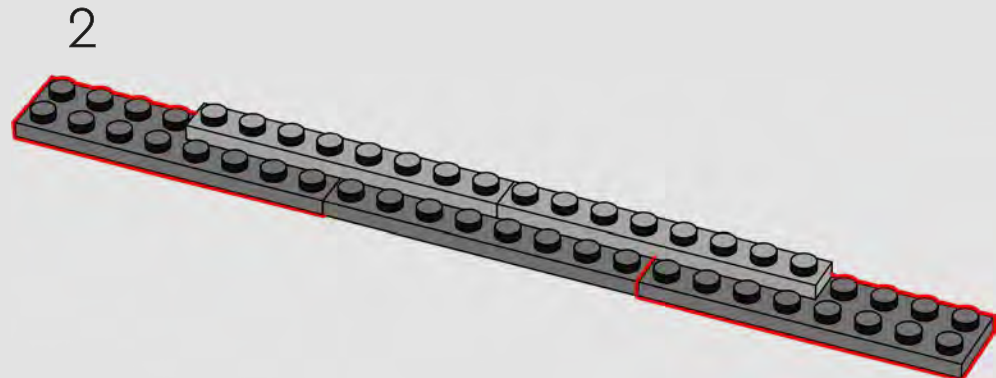

2

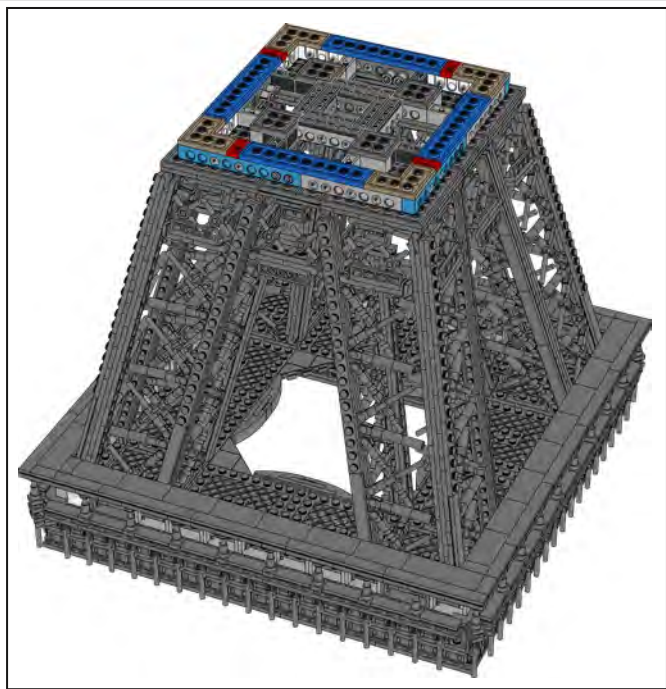

3

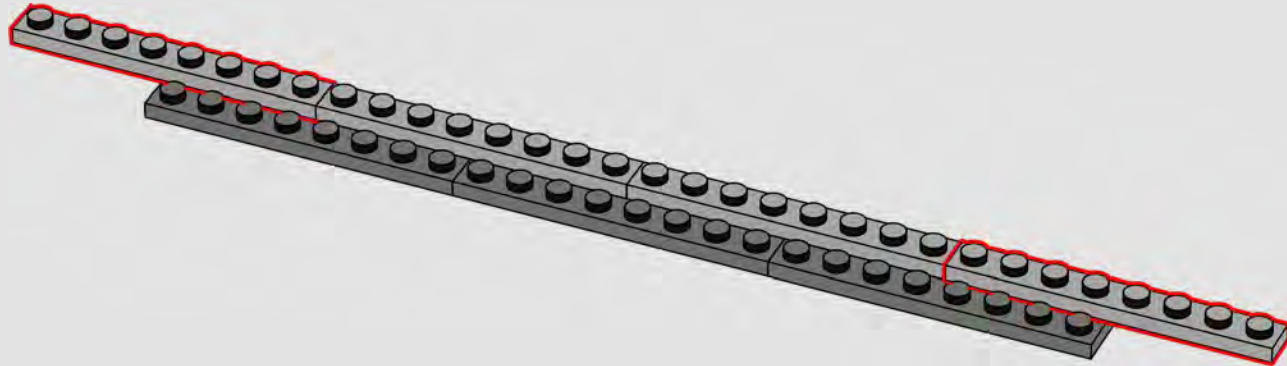

4

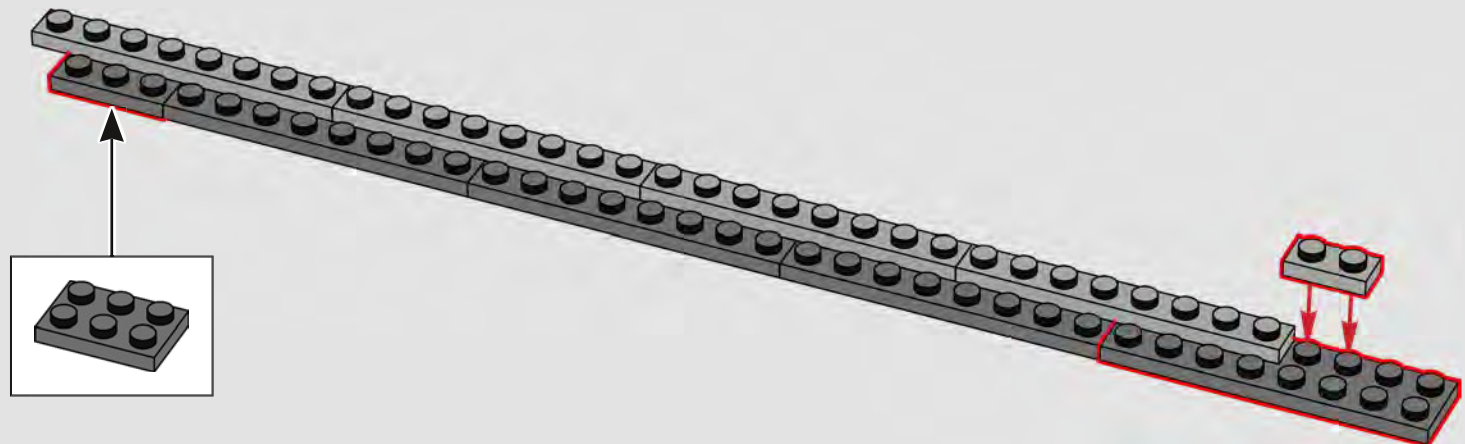

4X

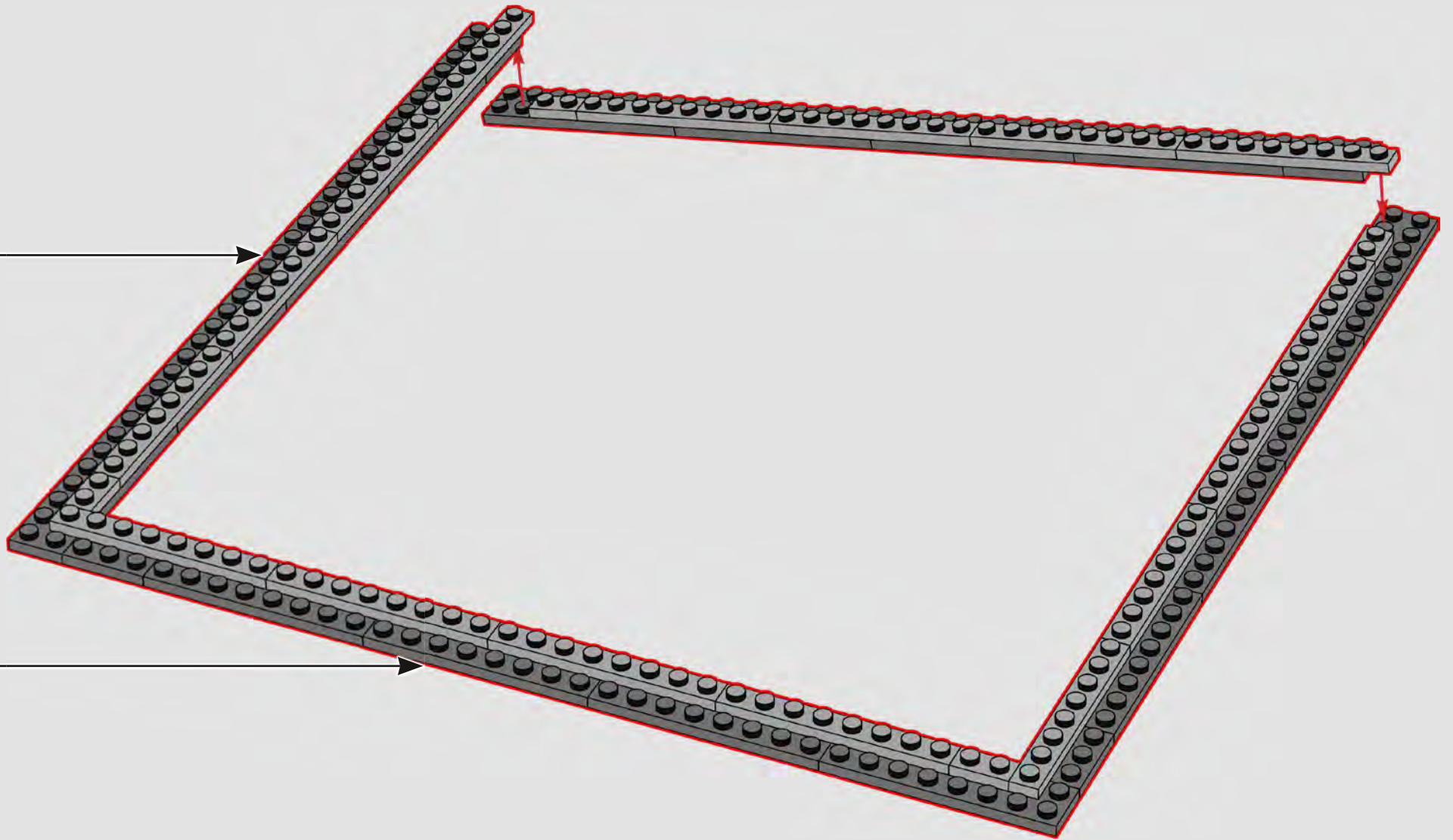

144x

263

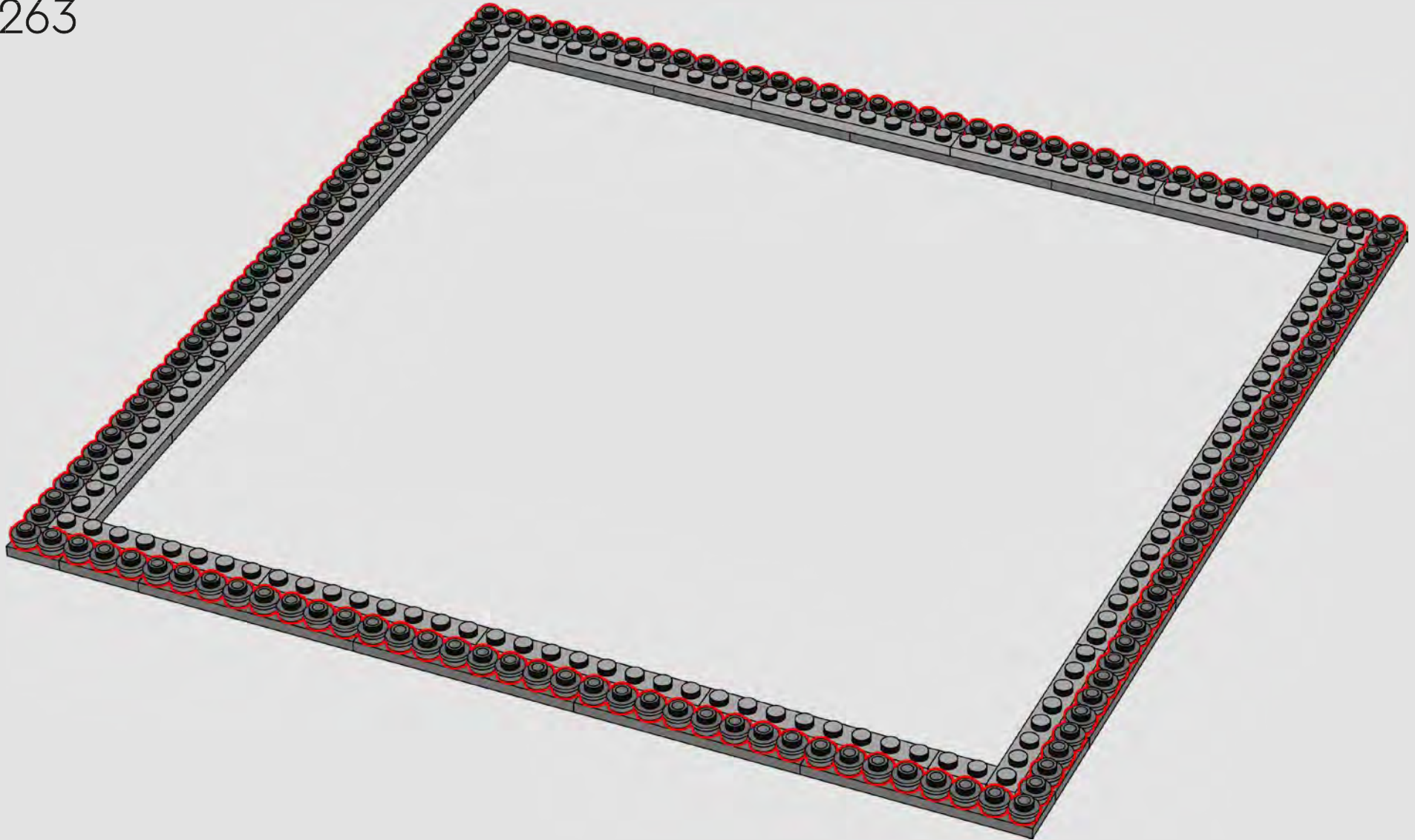



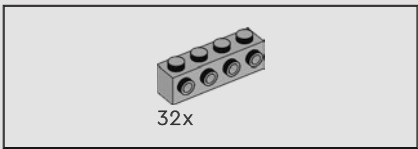

264

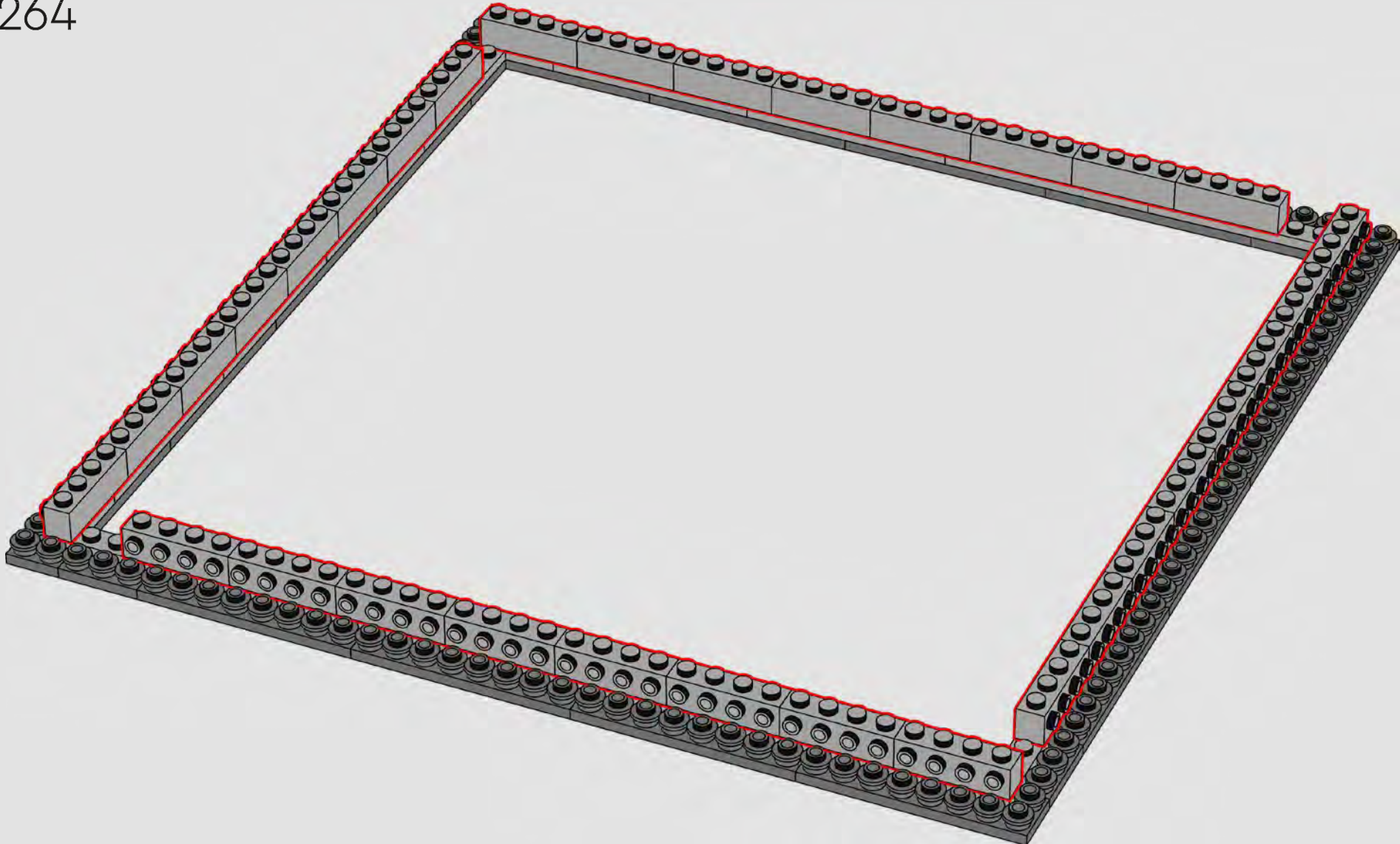



4x

265

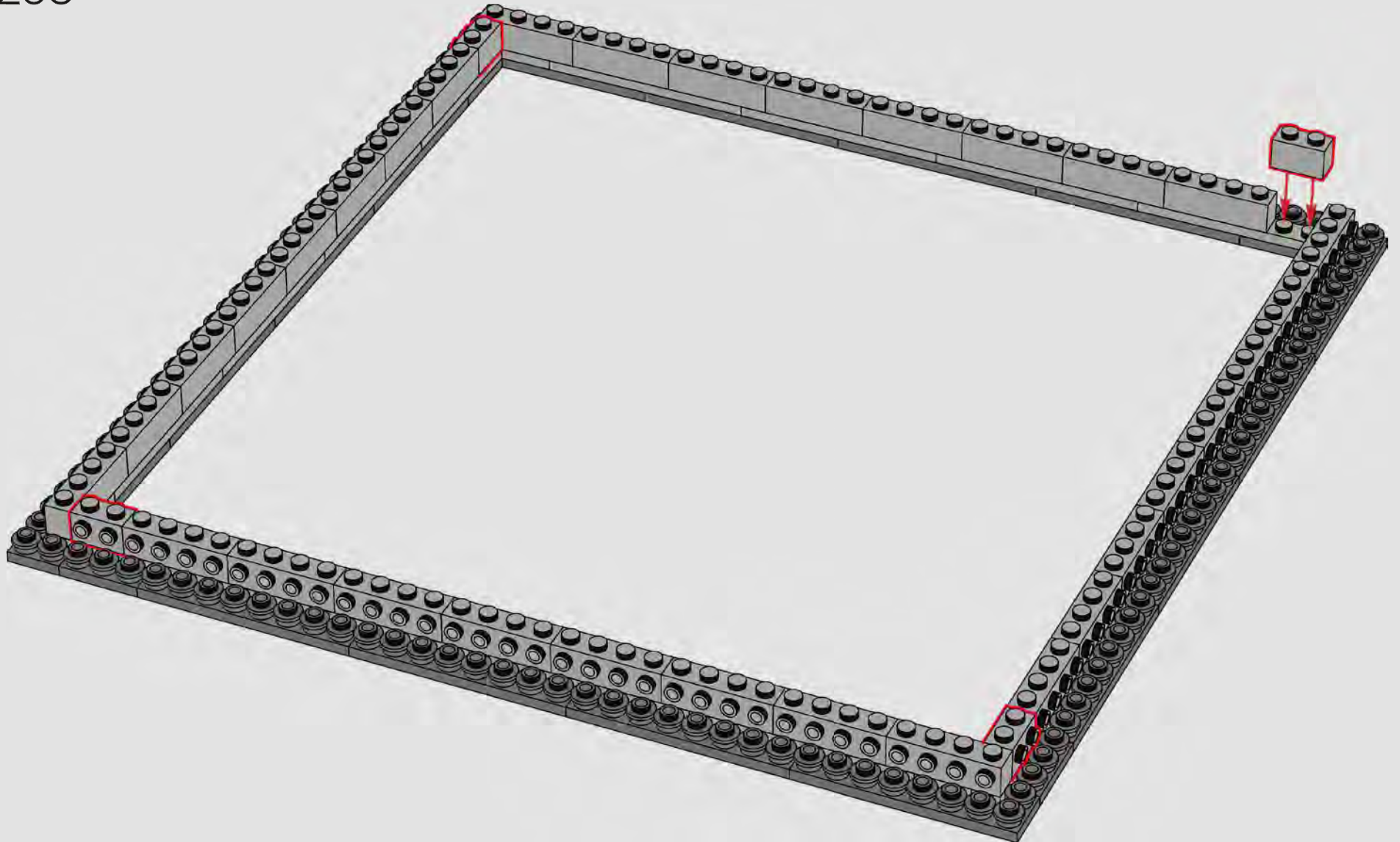

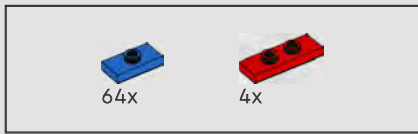

266

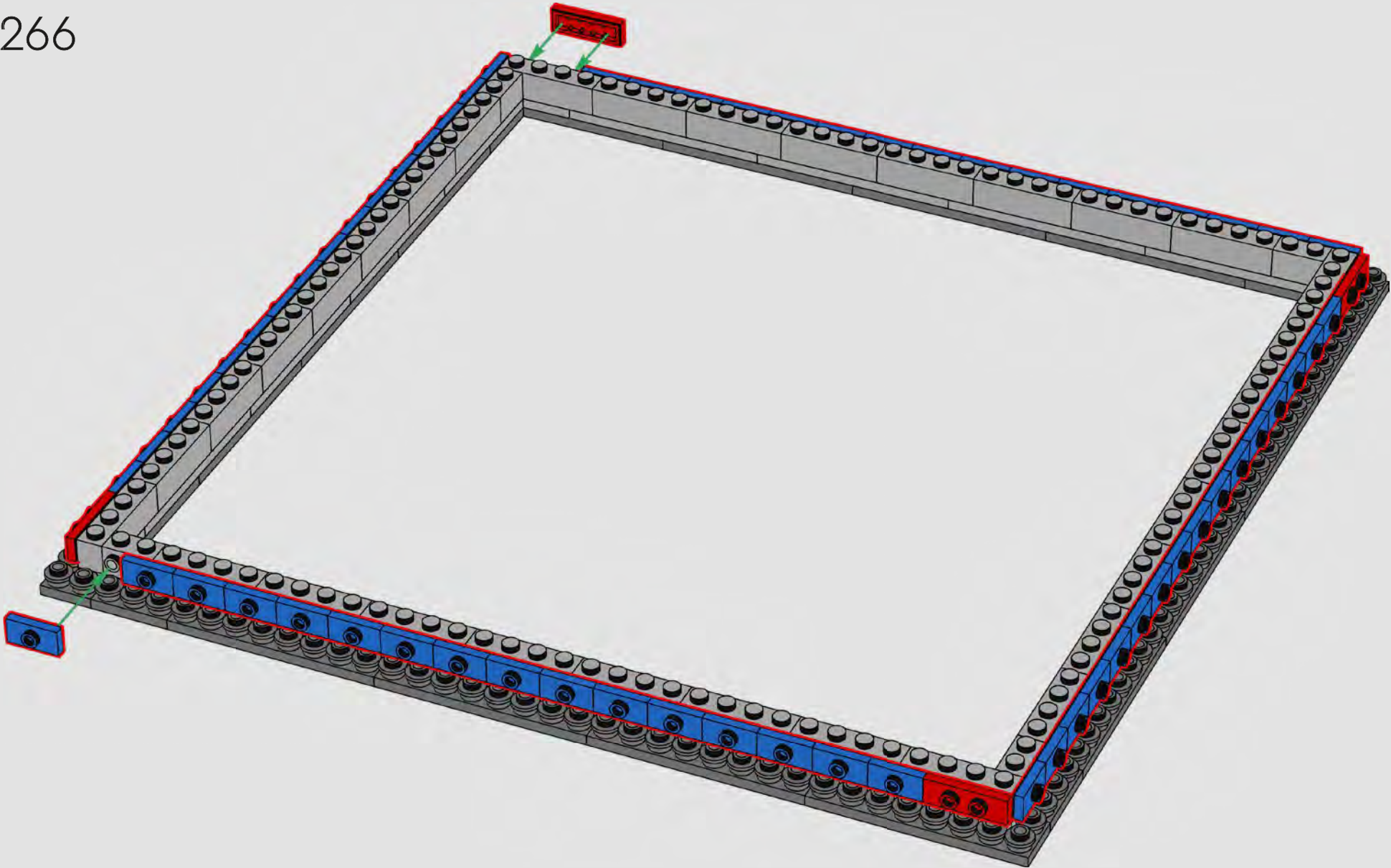

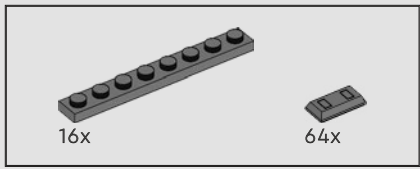

267

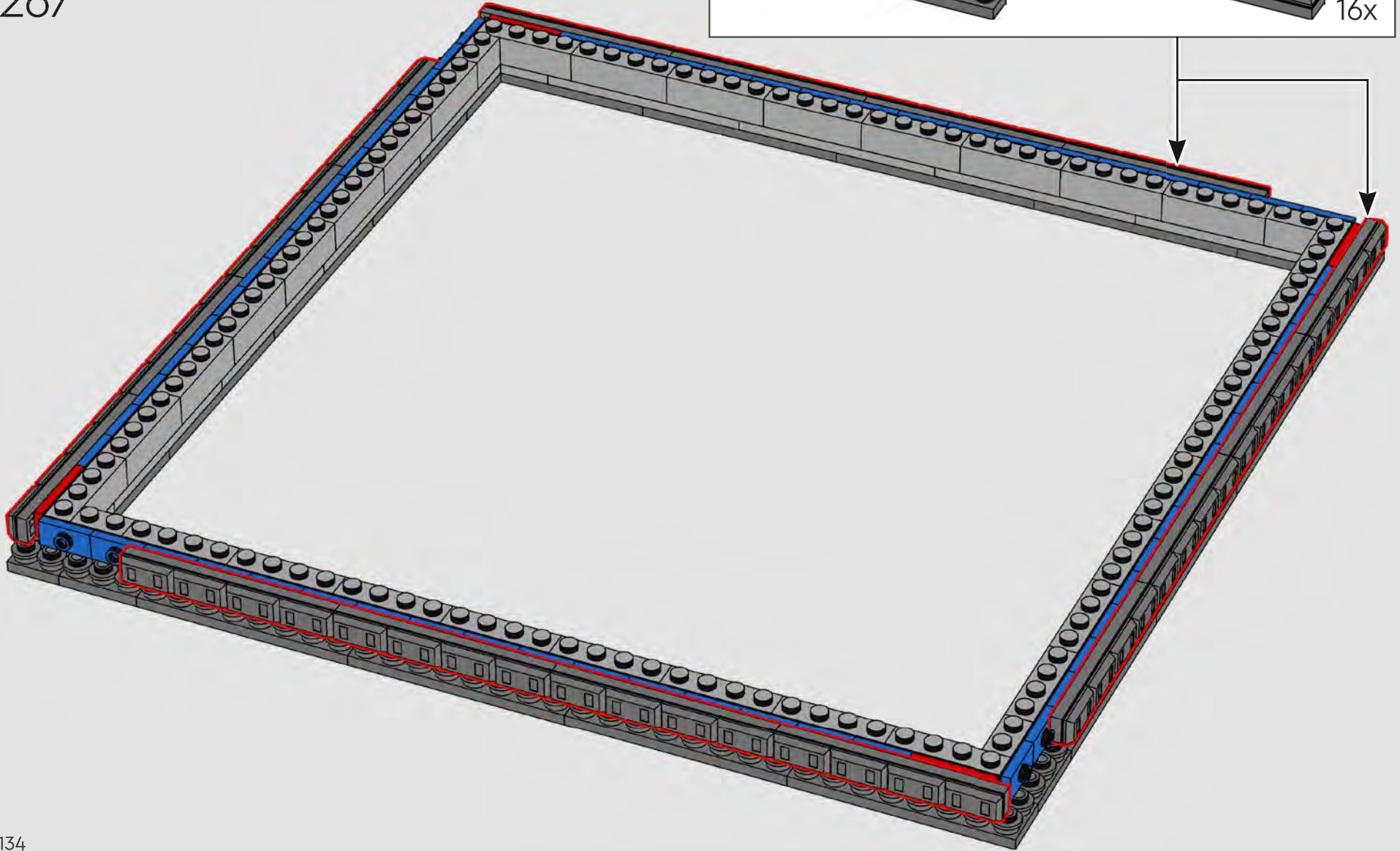
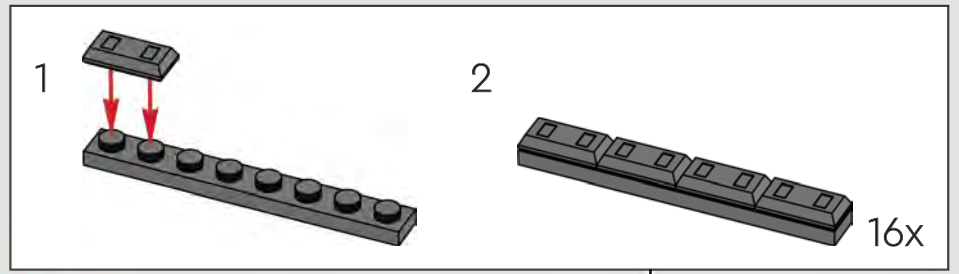



Gustave Eiffel engraved the names of 72 French scientists, engineers and mathematicians into the tower. On the LEGO® model the names are represented by 72 LEGO Ingot pieces.

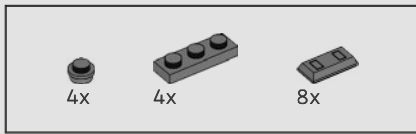

268

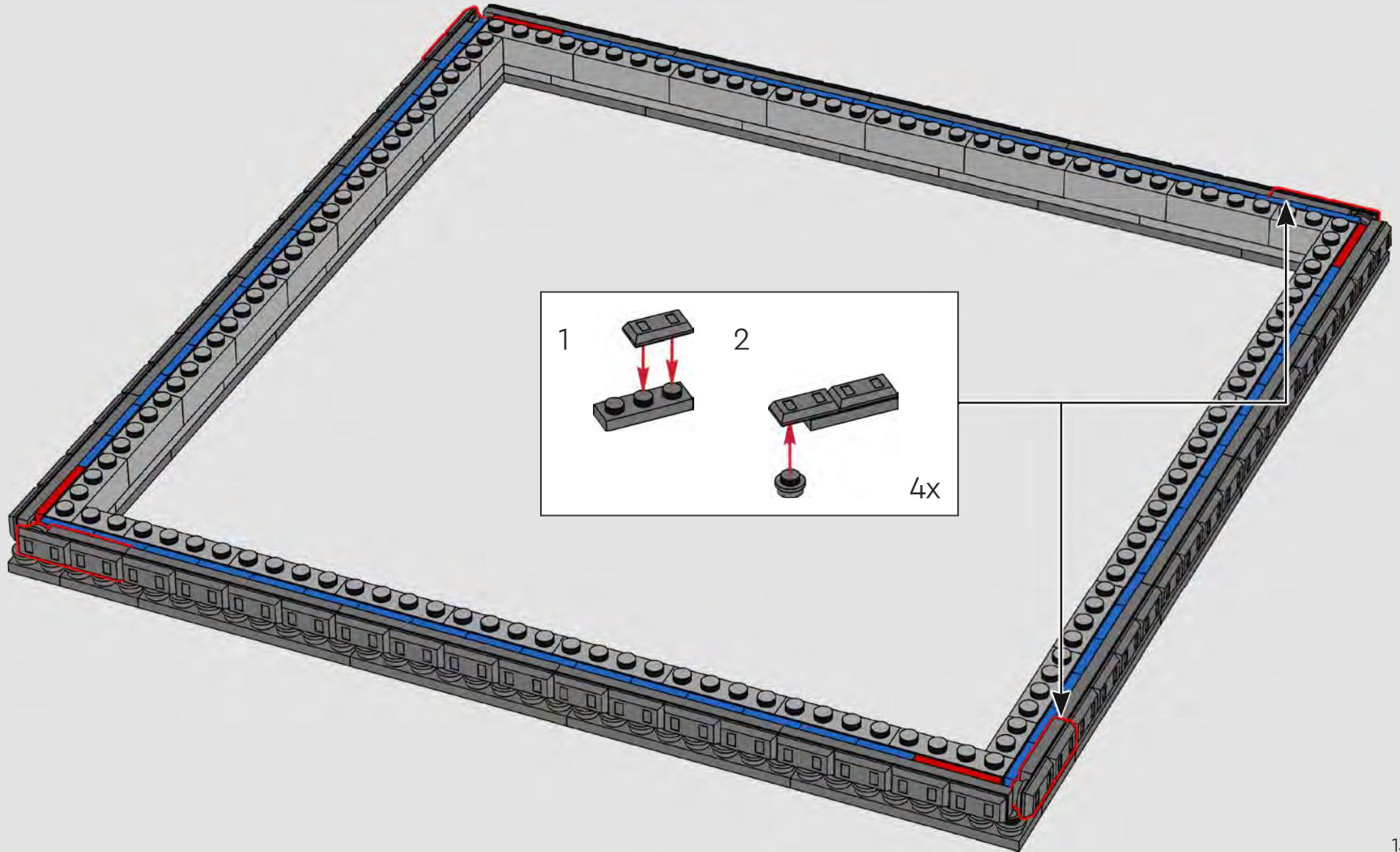

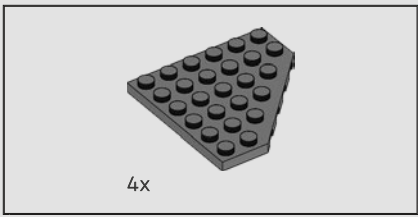

269

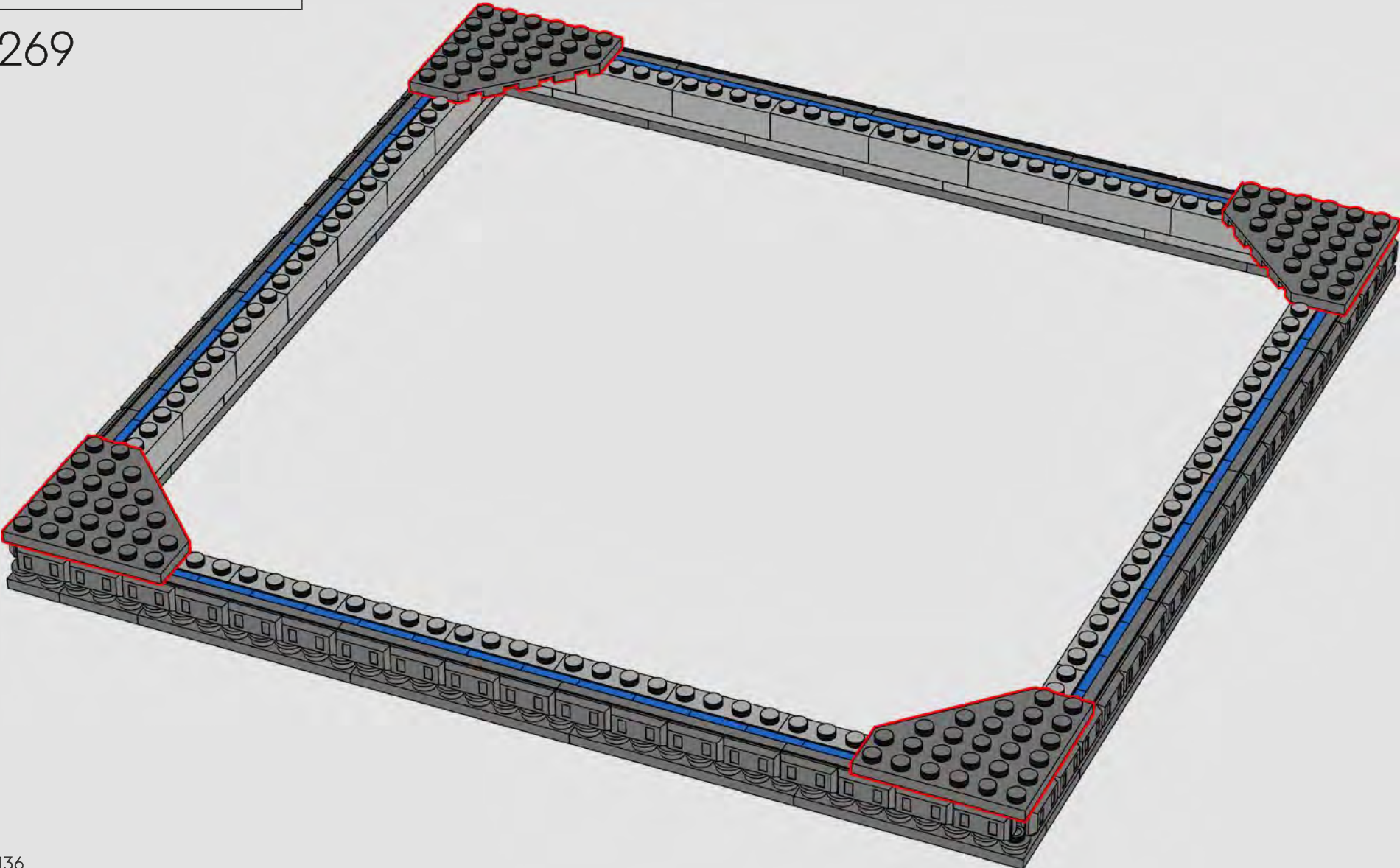

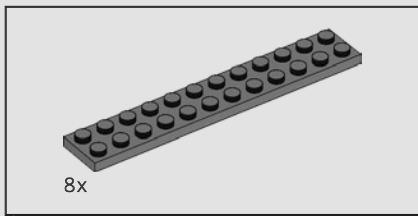

270

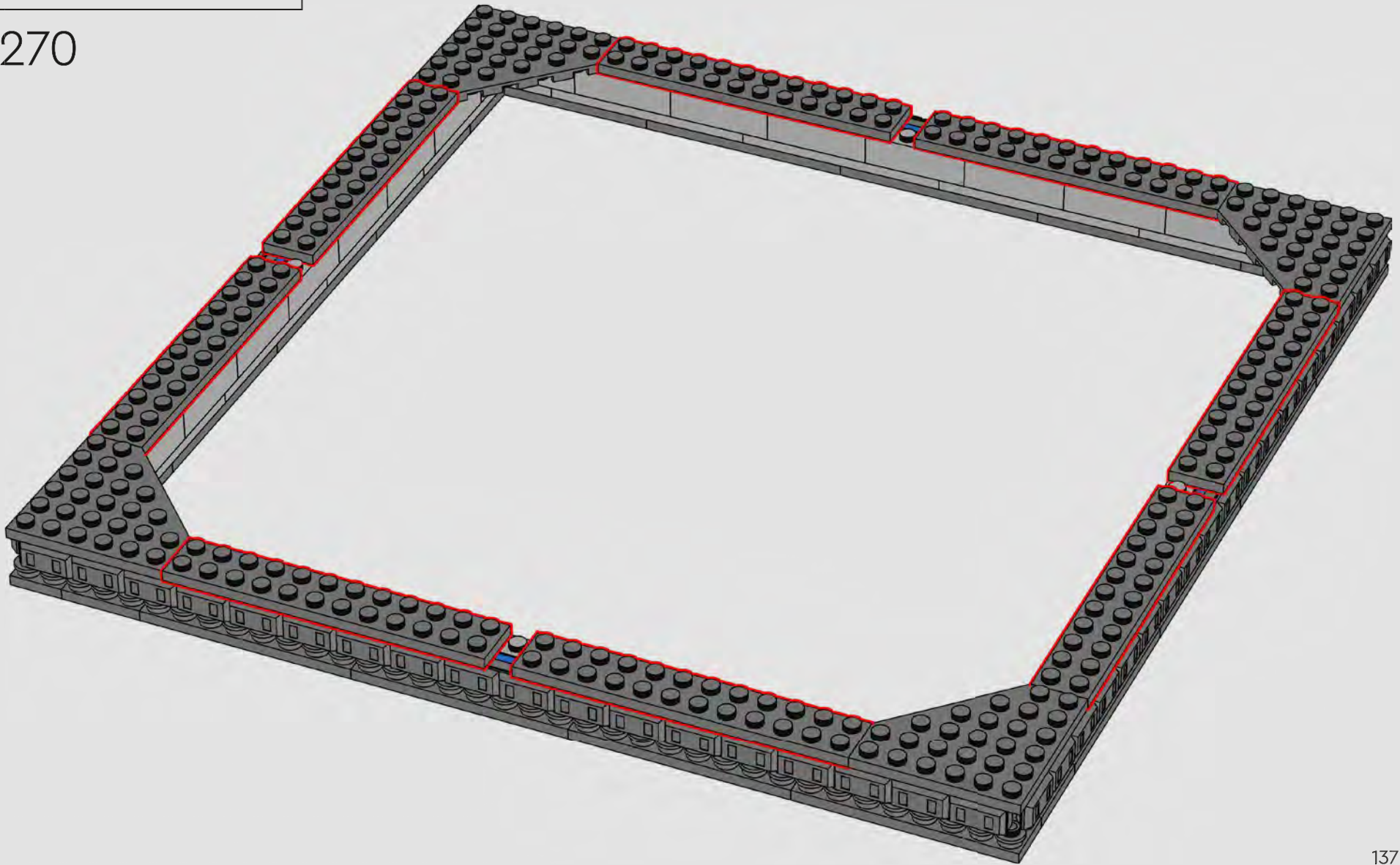



4x

271

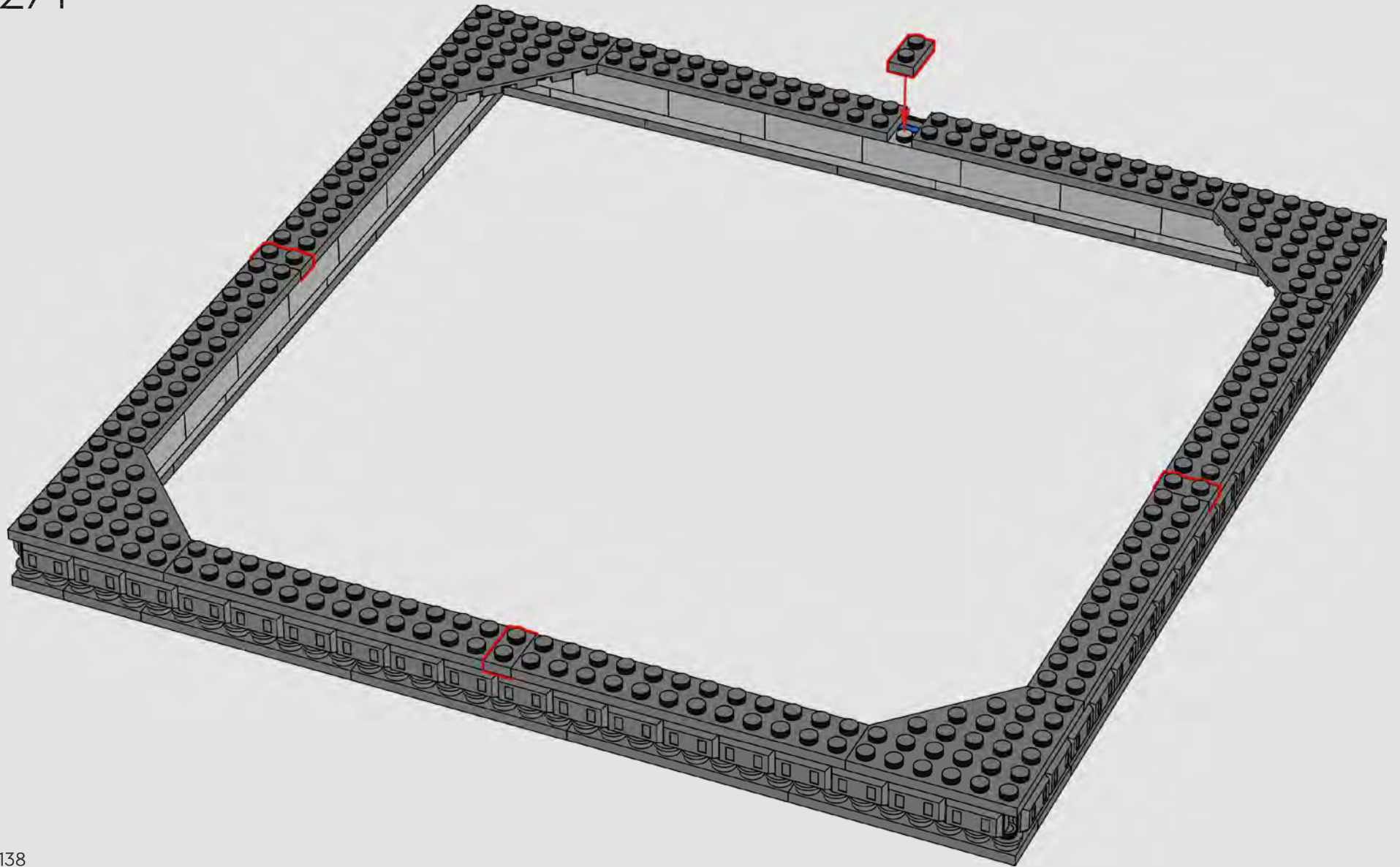

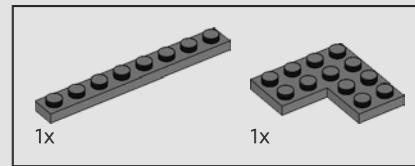
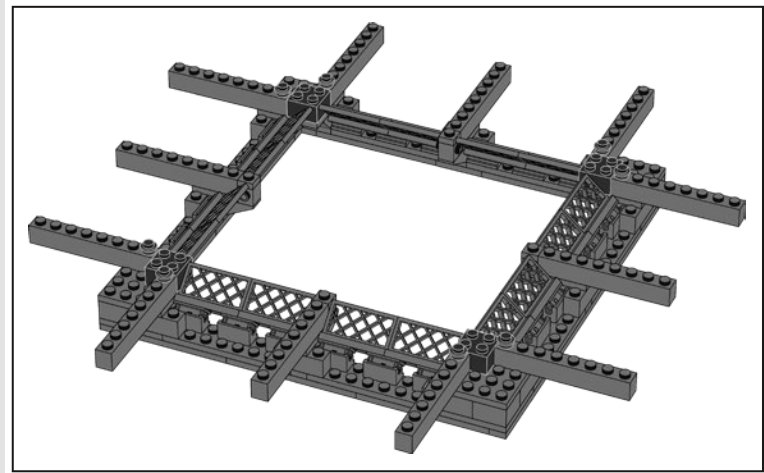

272

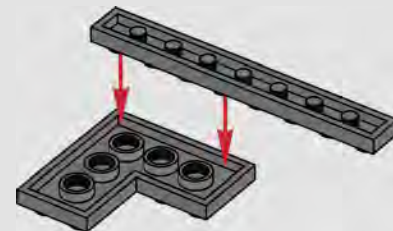

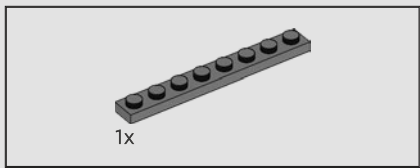

273

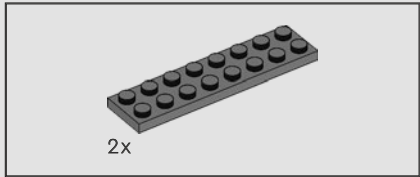
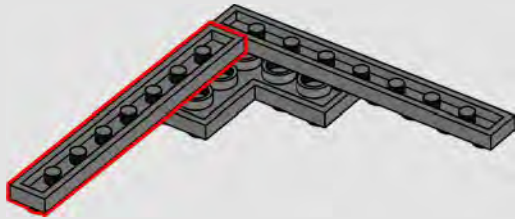

274

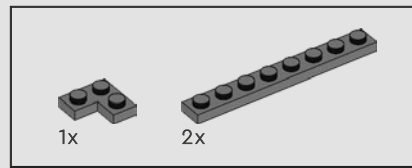
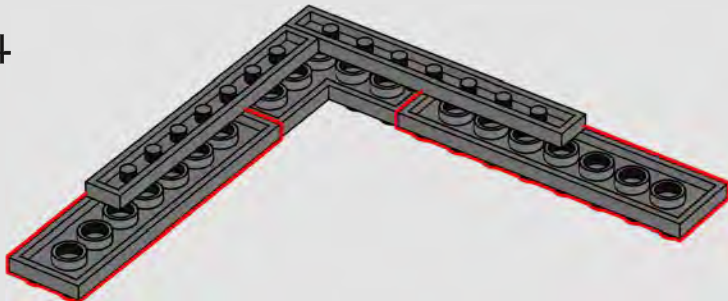

275

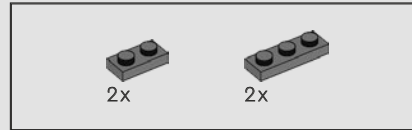
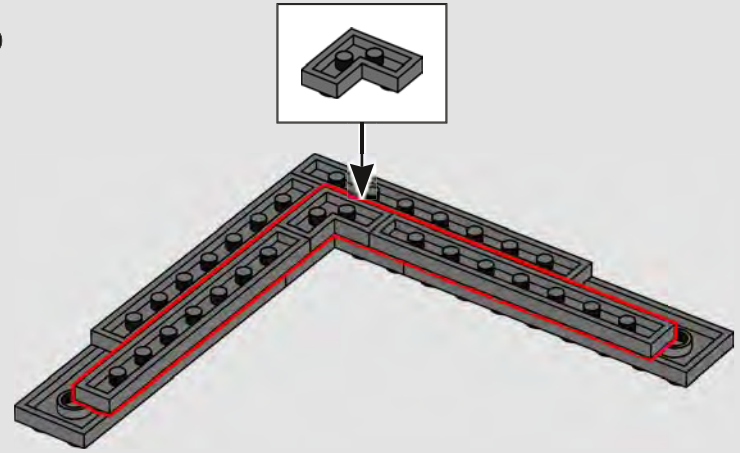

276

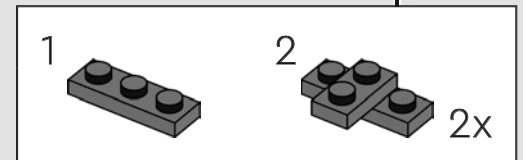
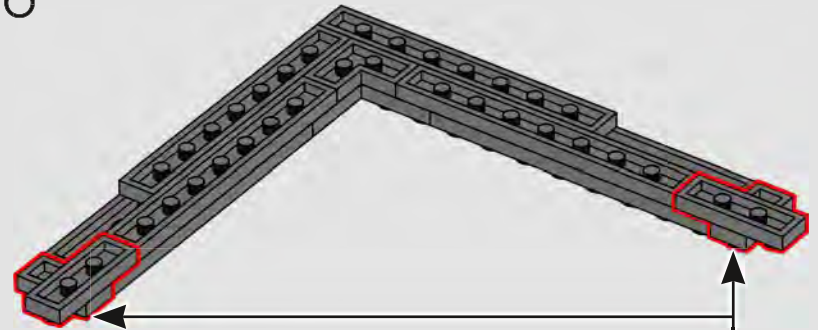

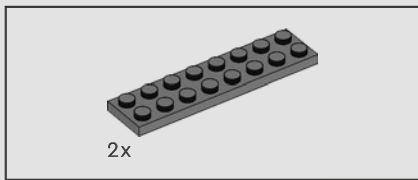

277

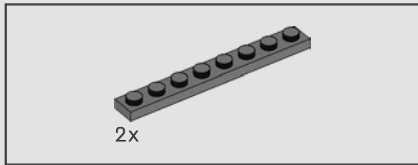
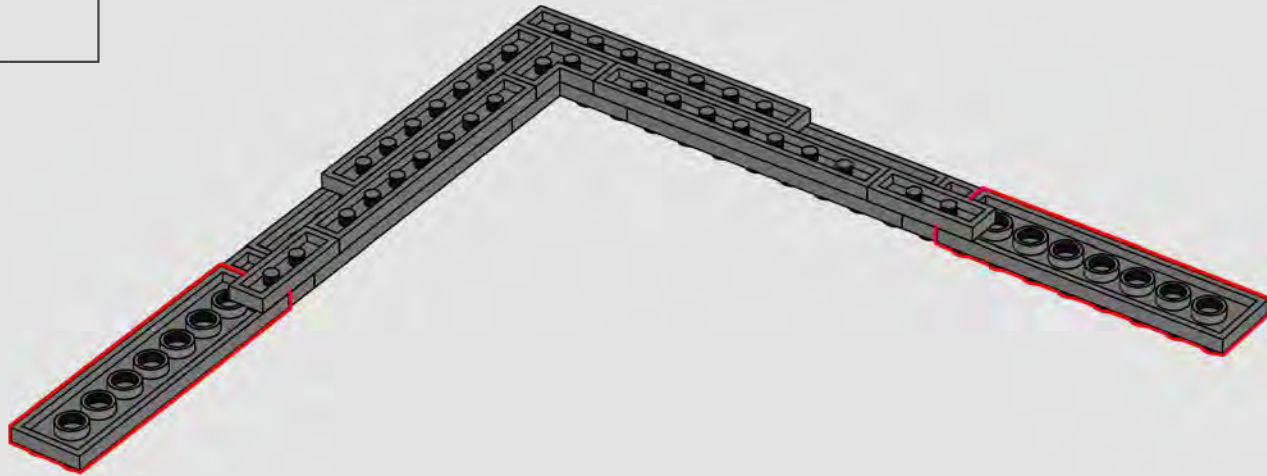

278

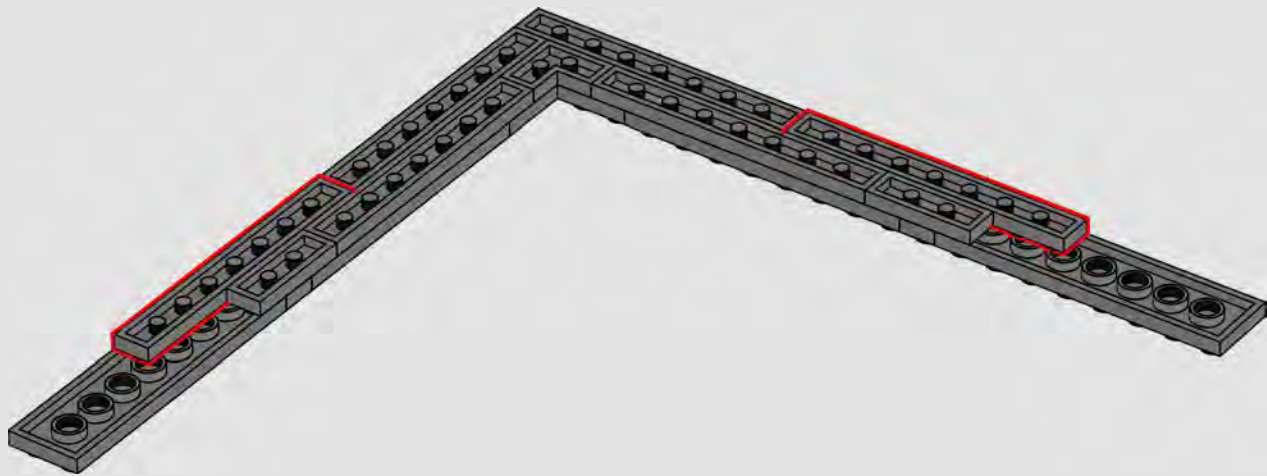

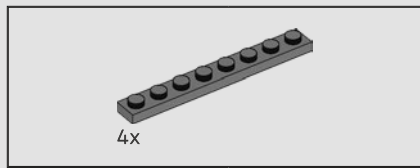

279

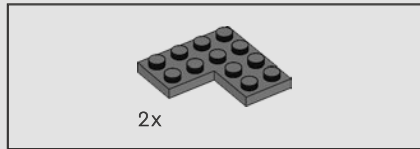
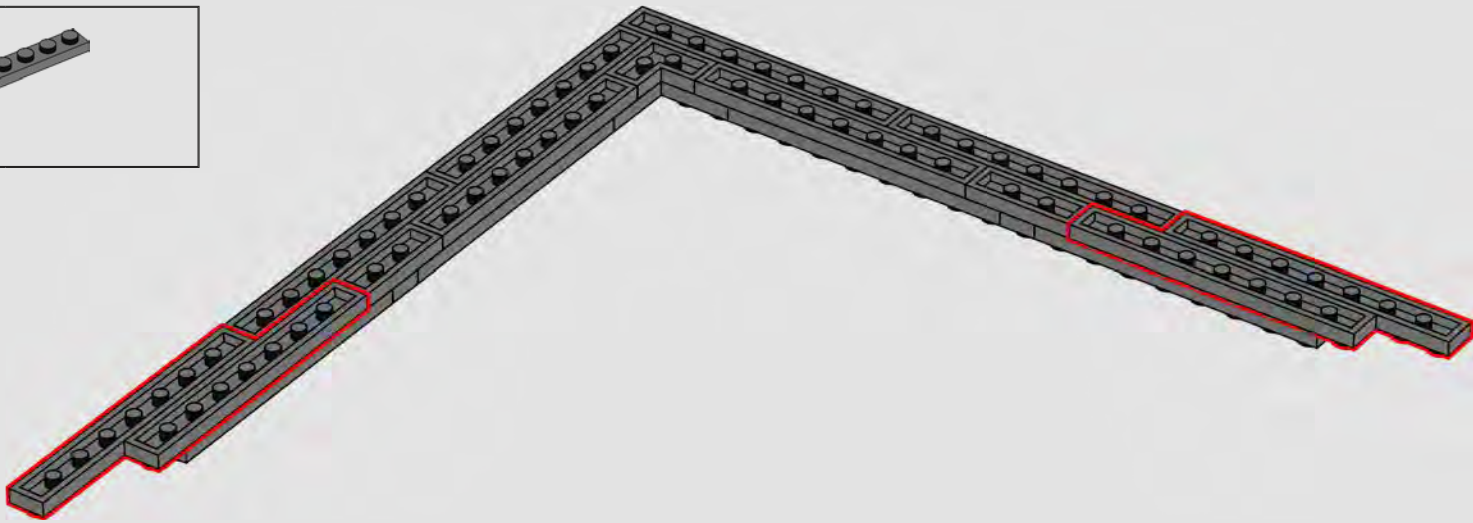

280

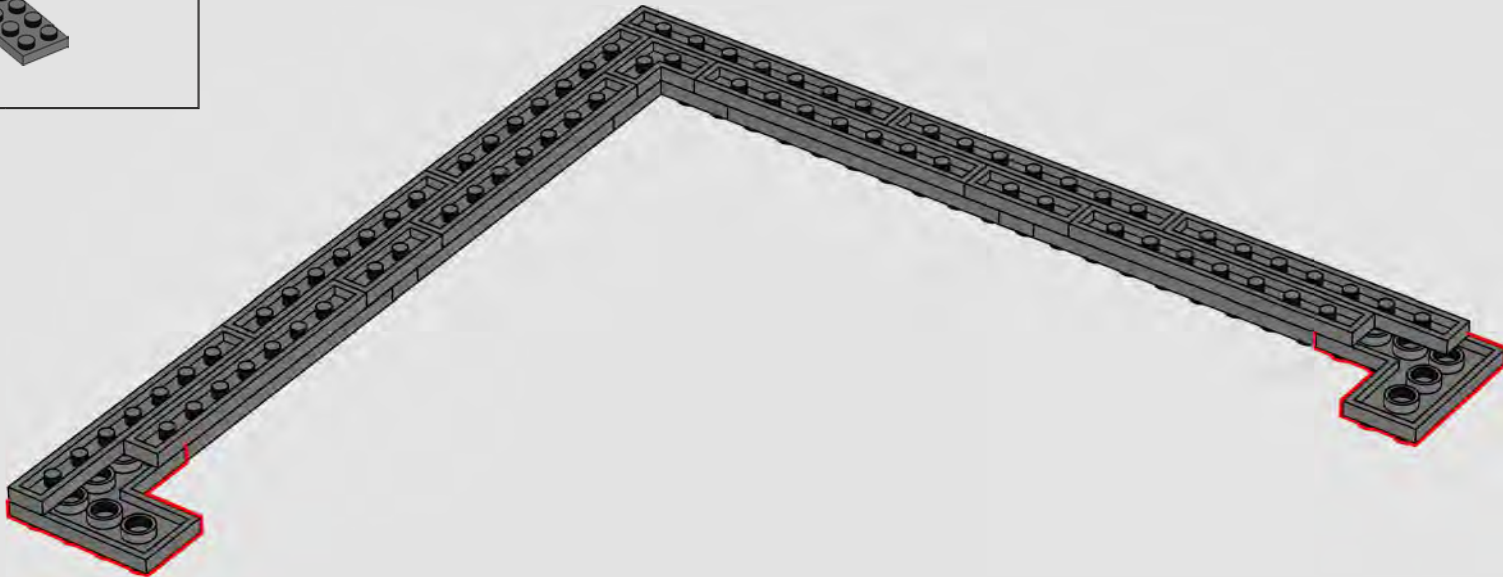

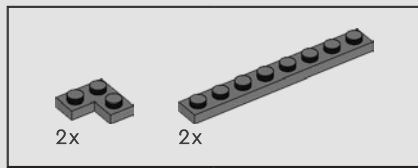

281

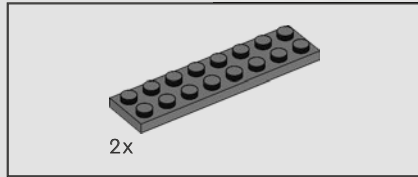
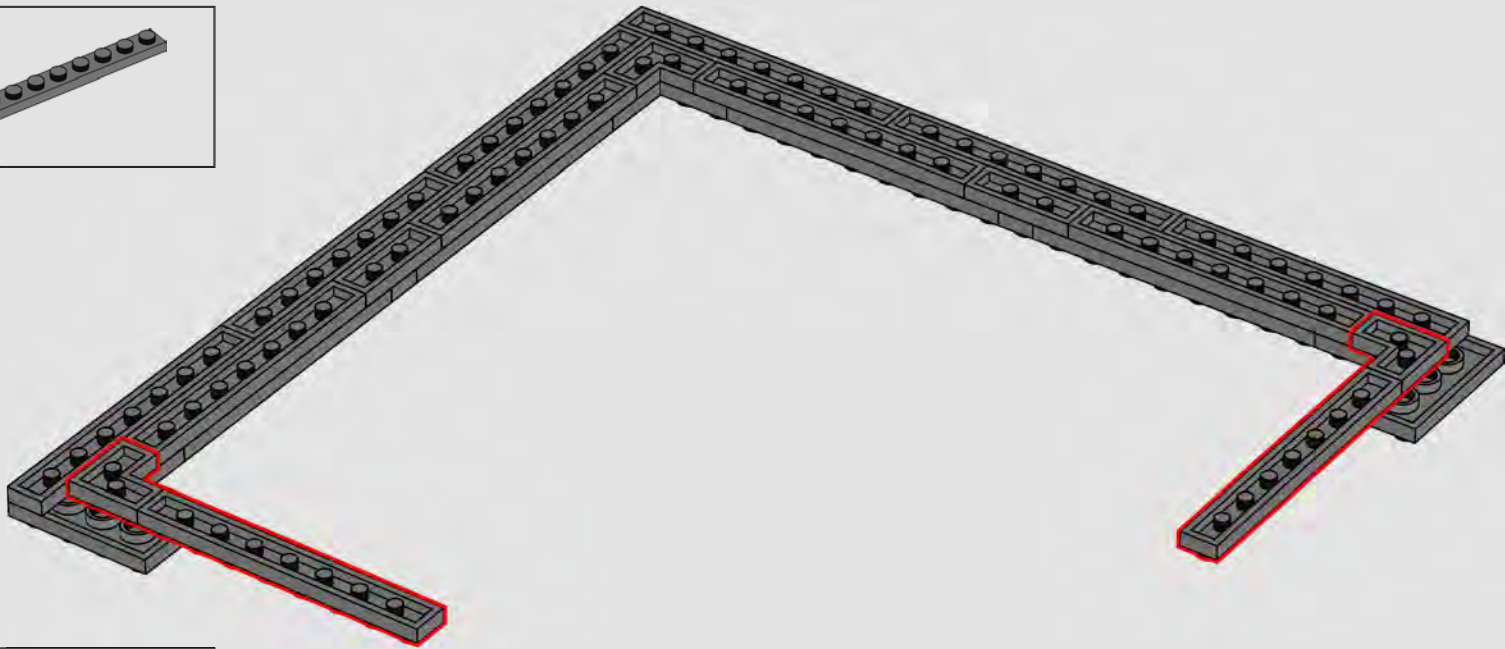

282

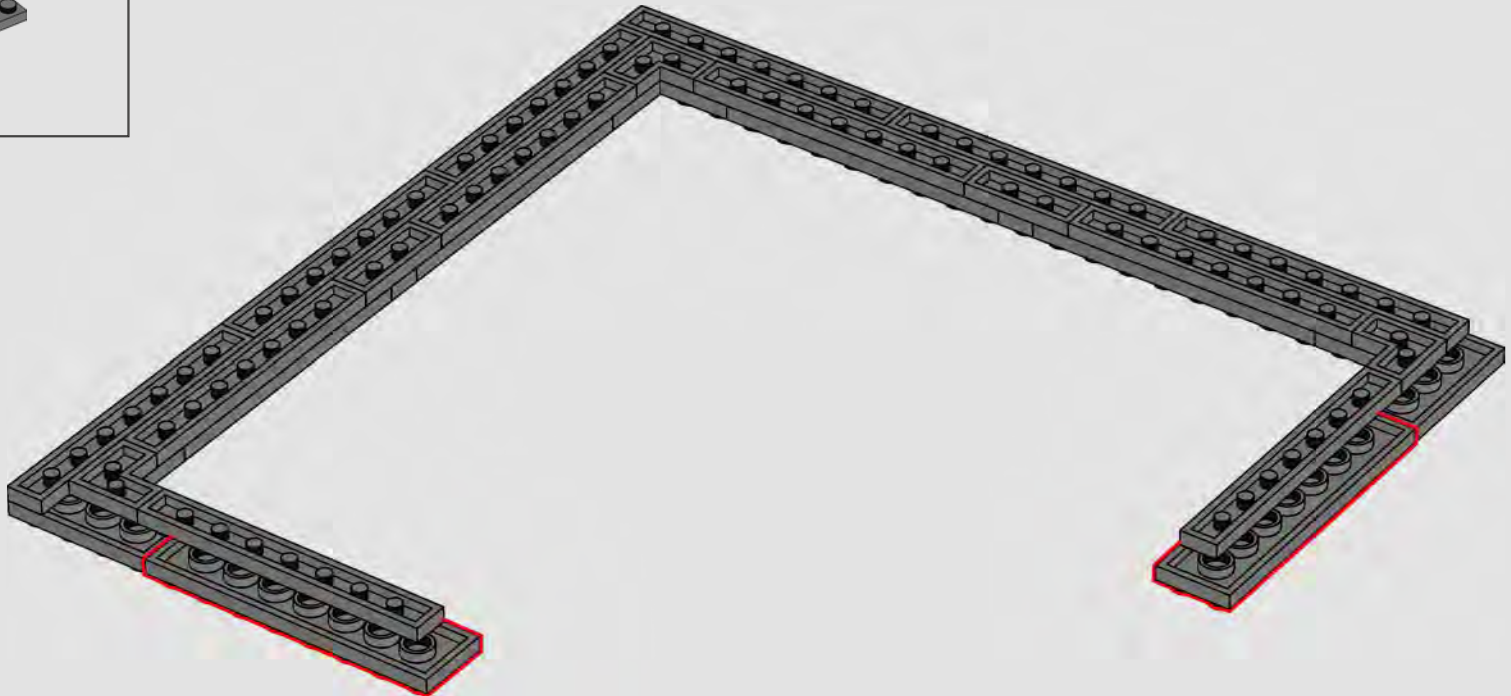

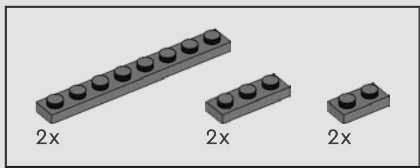

283

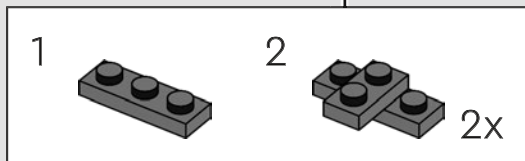
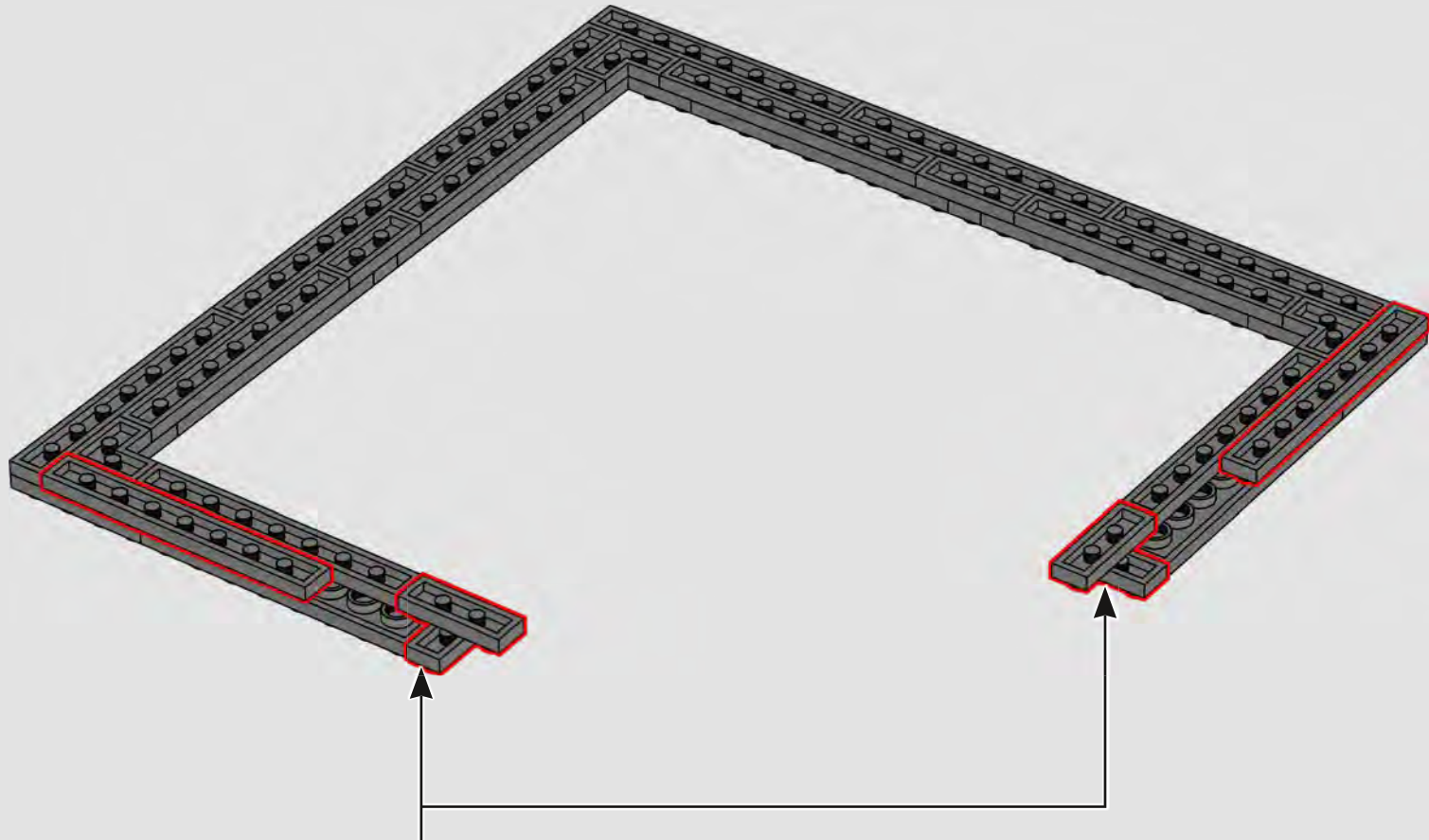

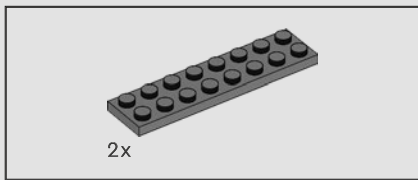

284

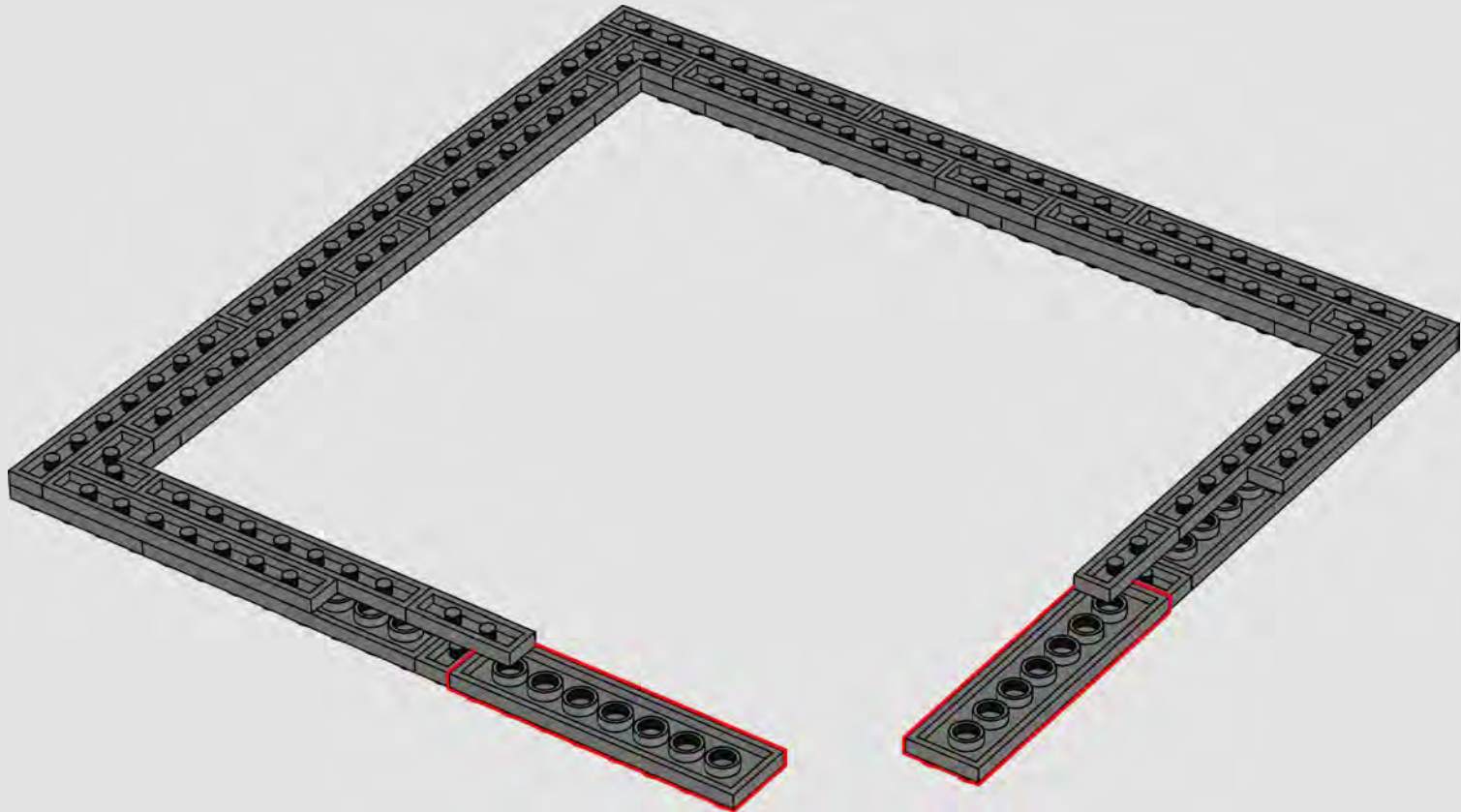

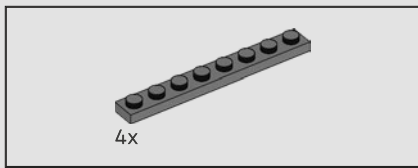

285

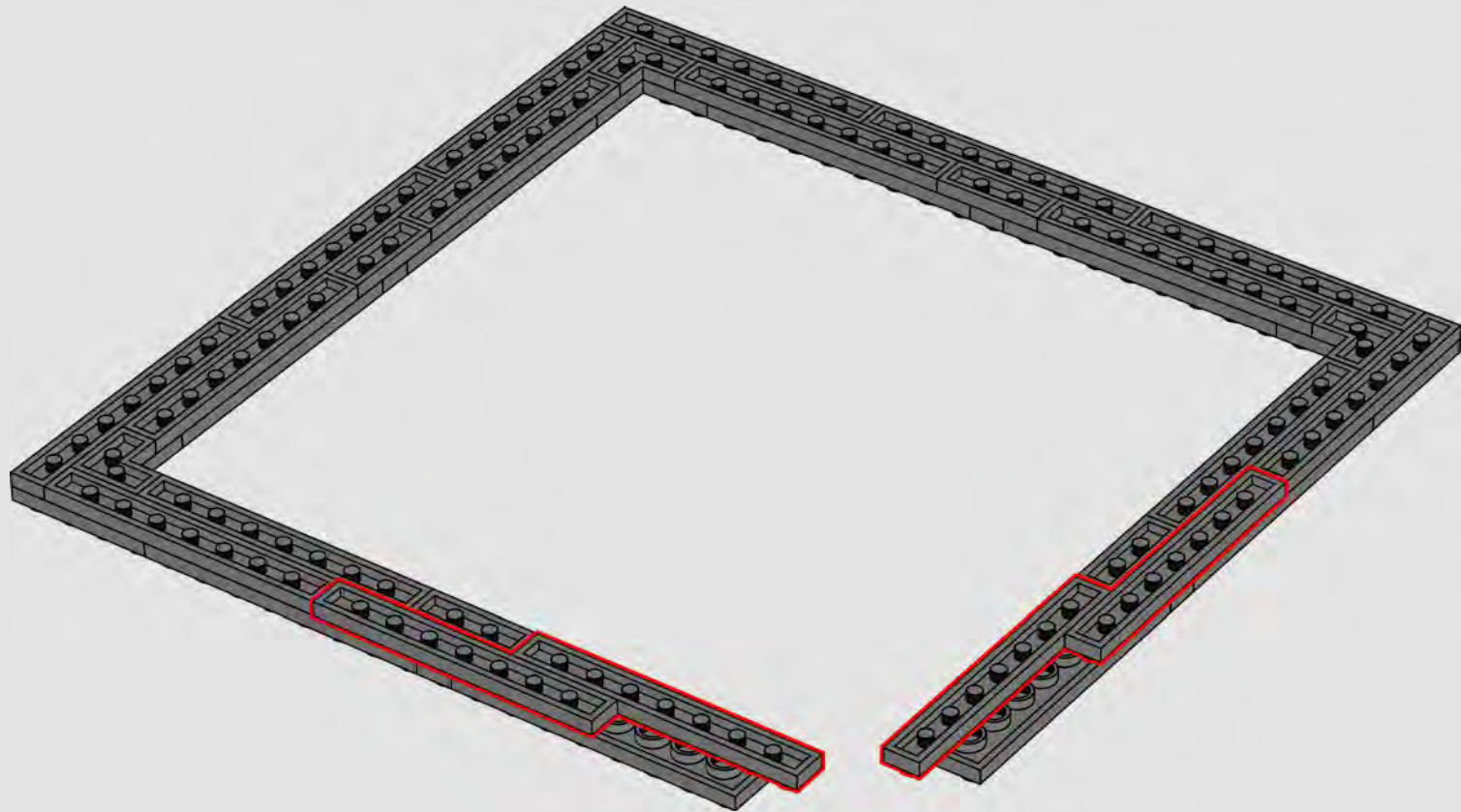

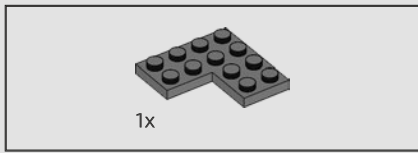

286

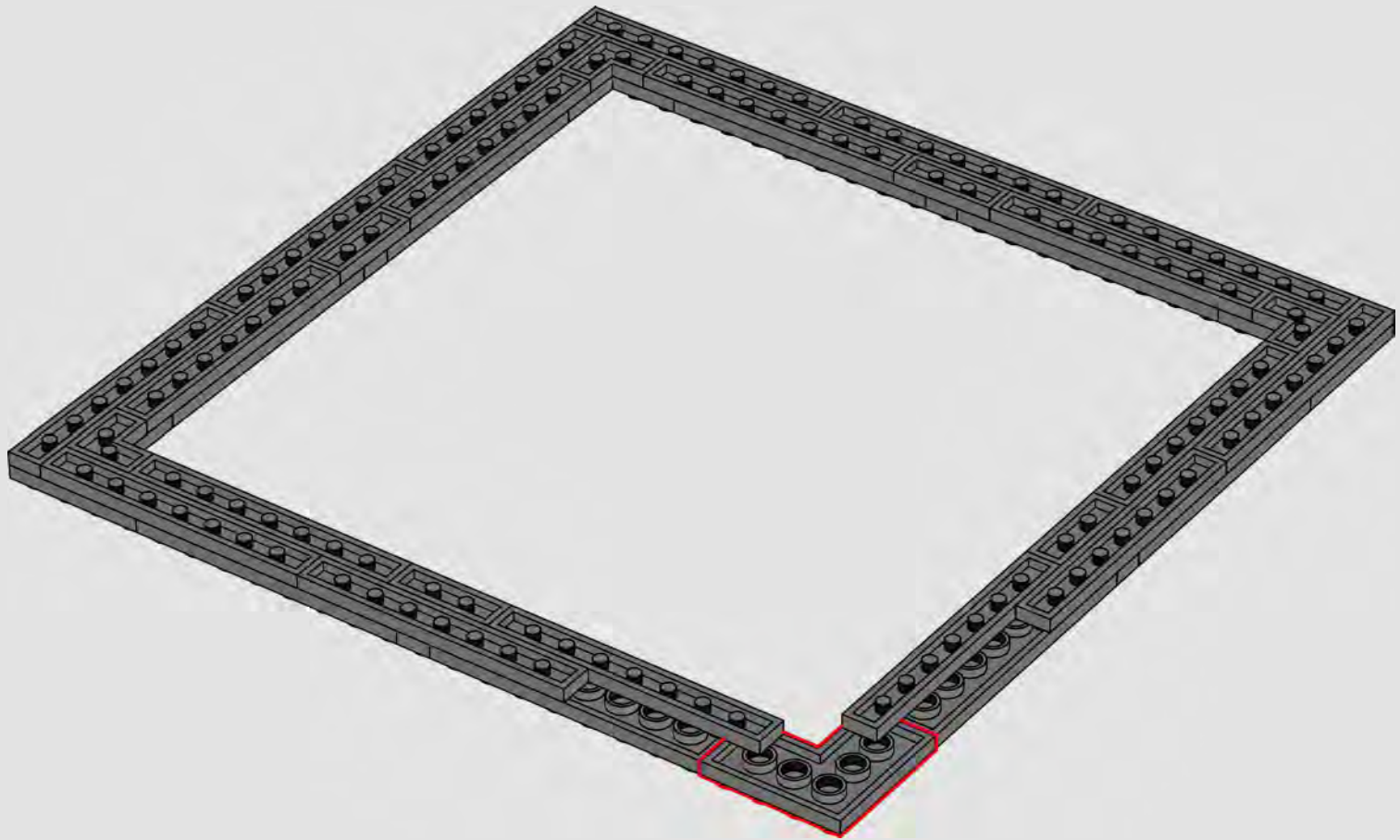

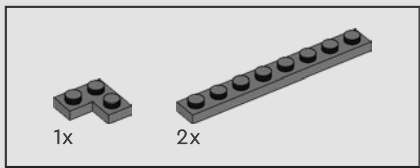

287

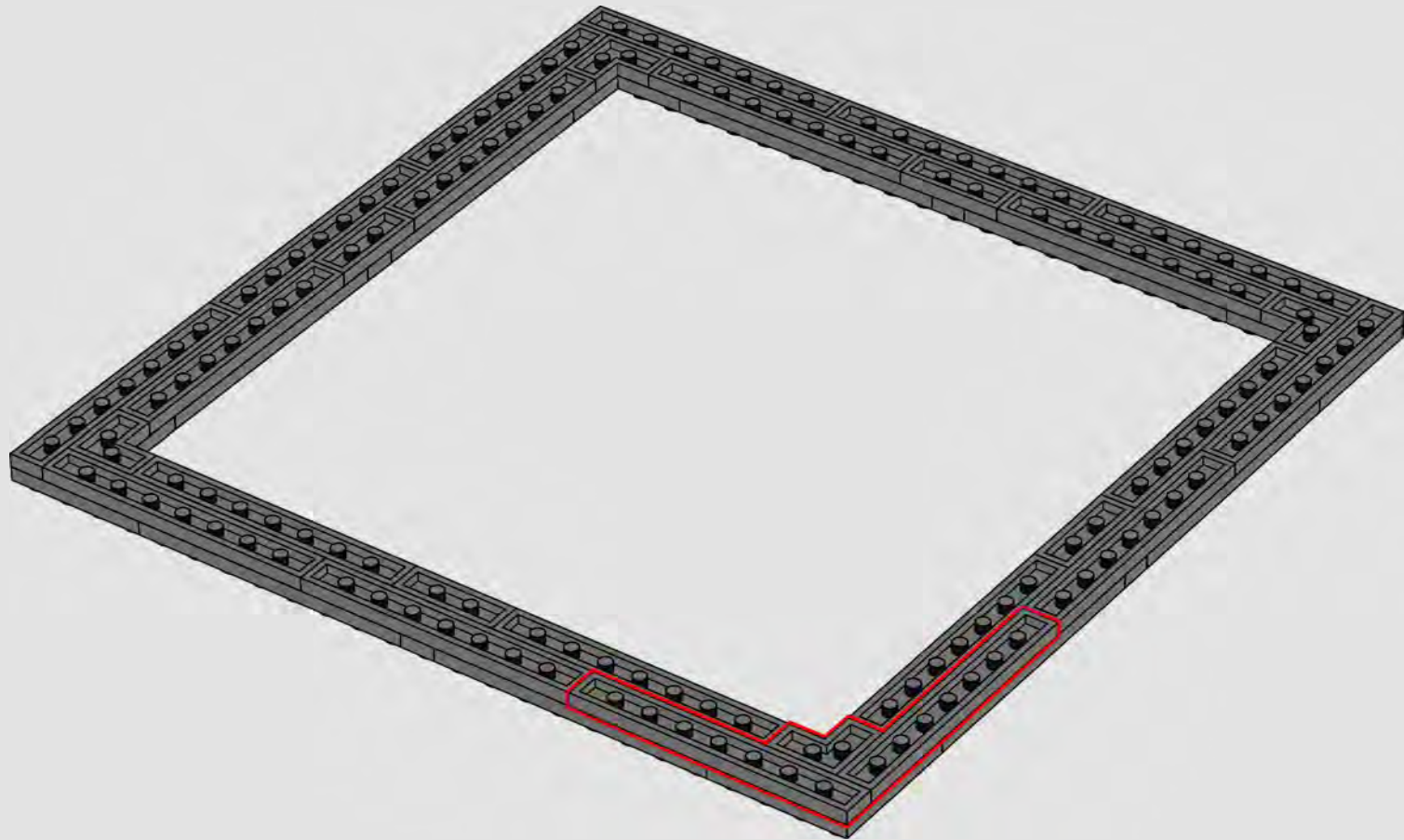

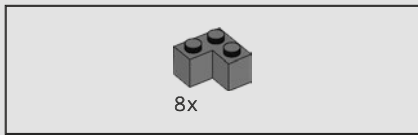

288

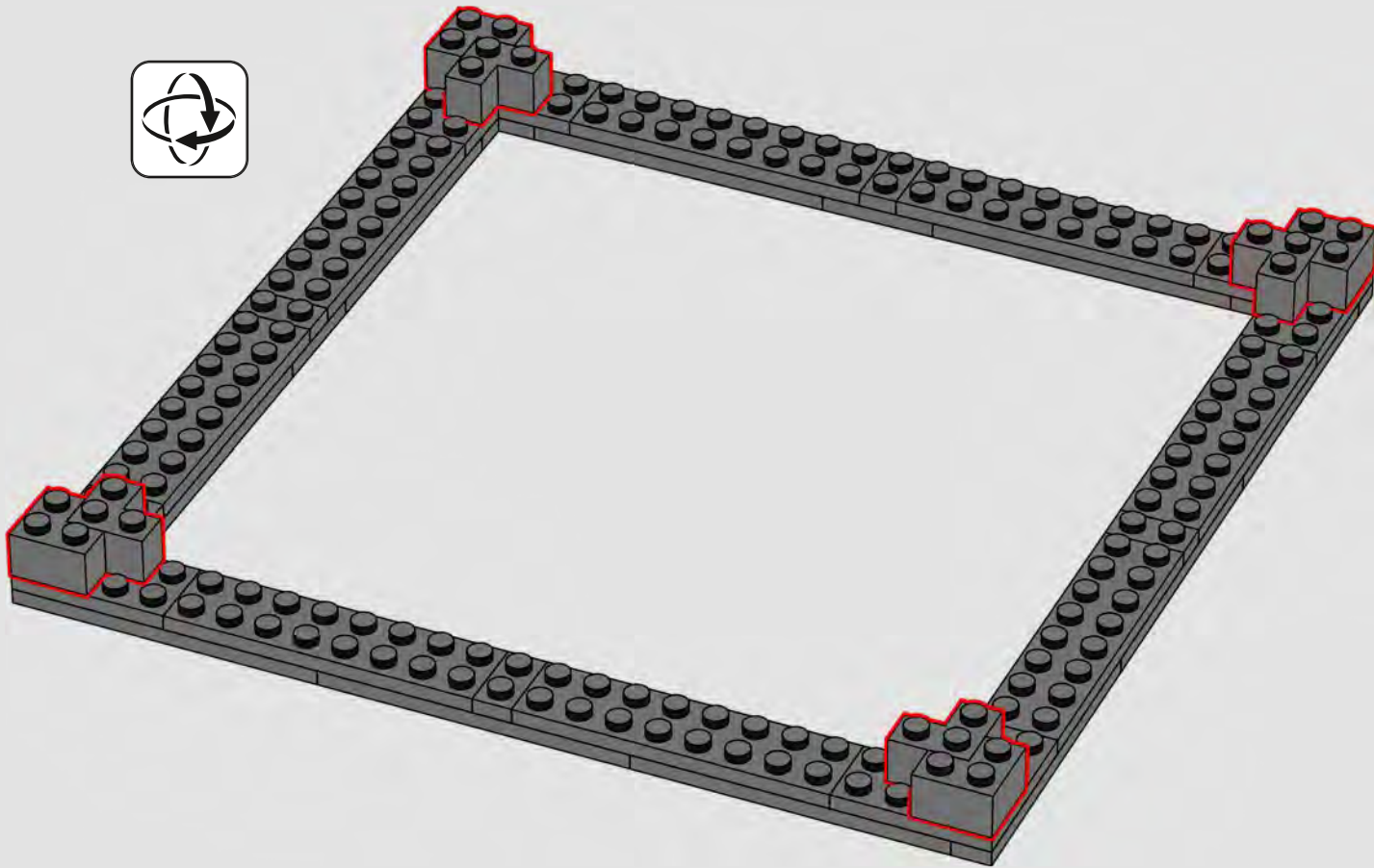



8x

289

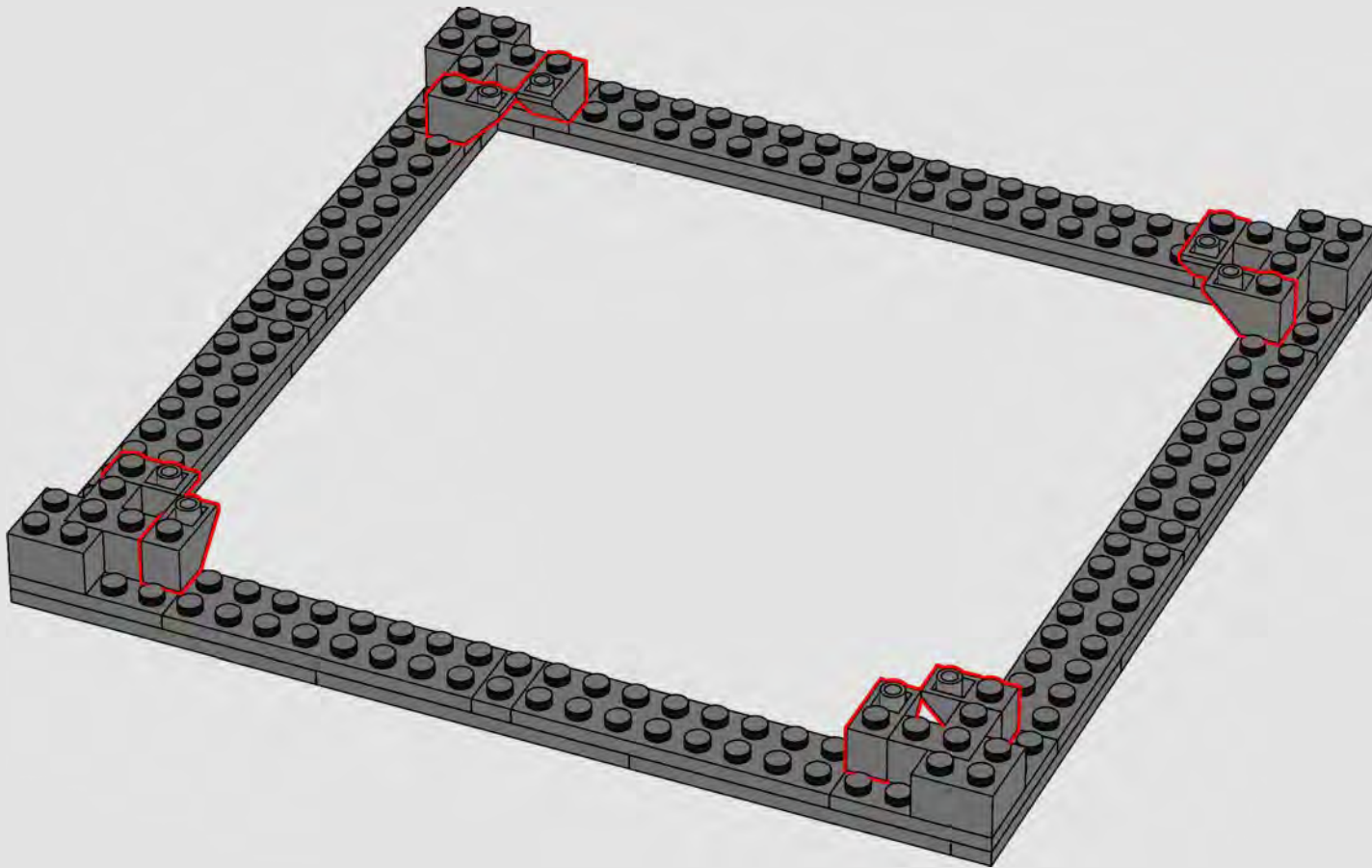

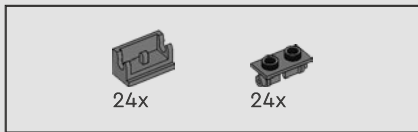

290

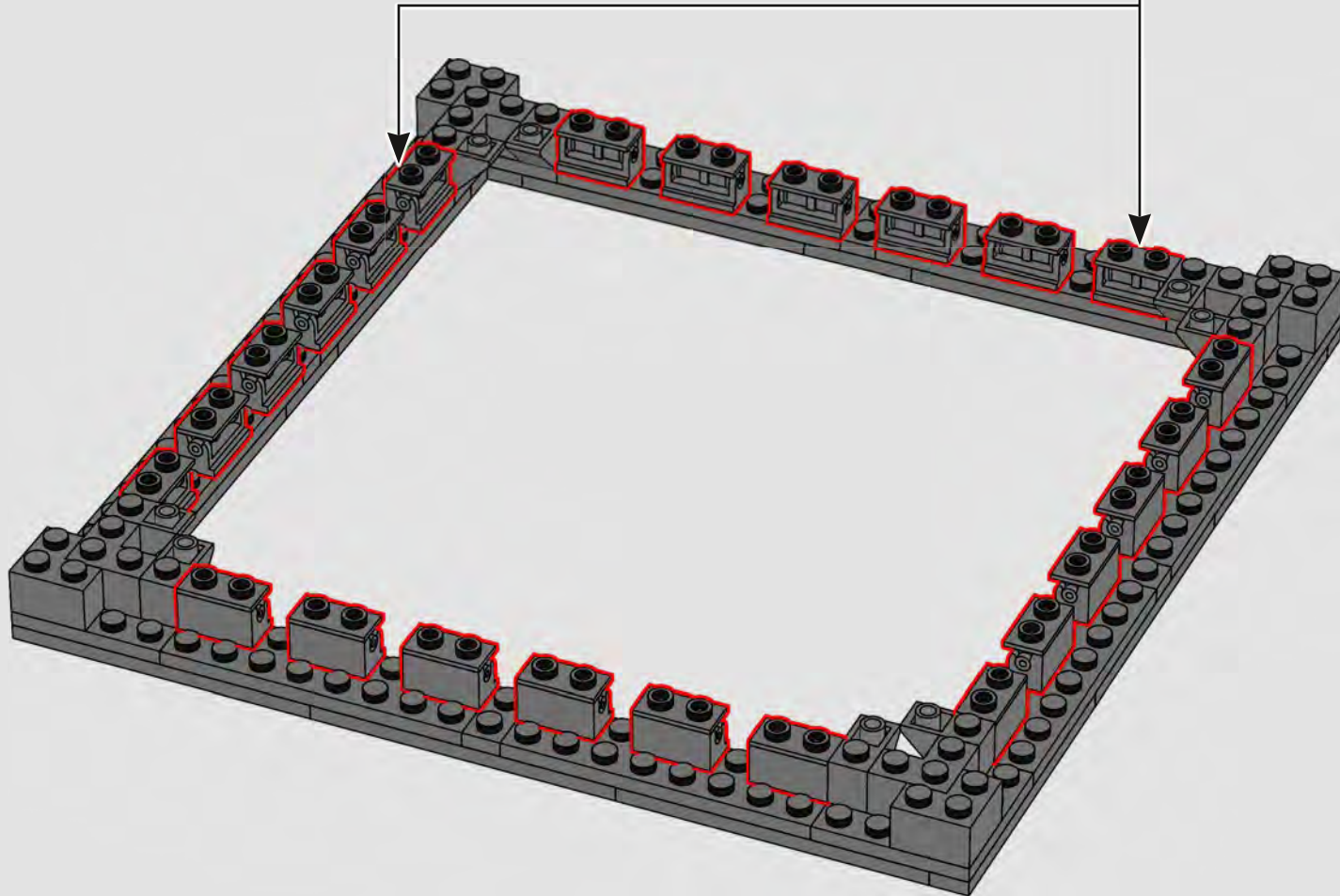
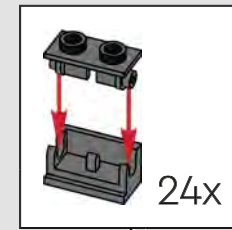

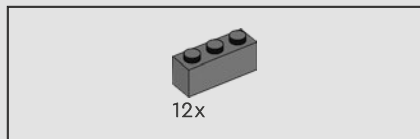

291

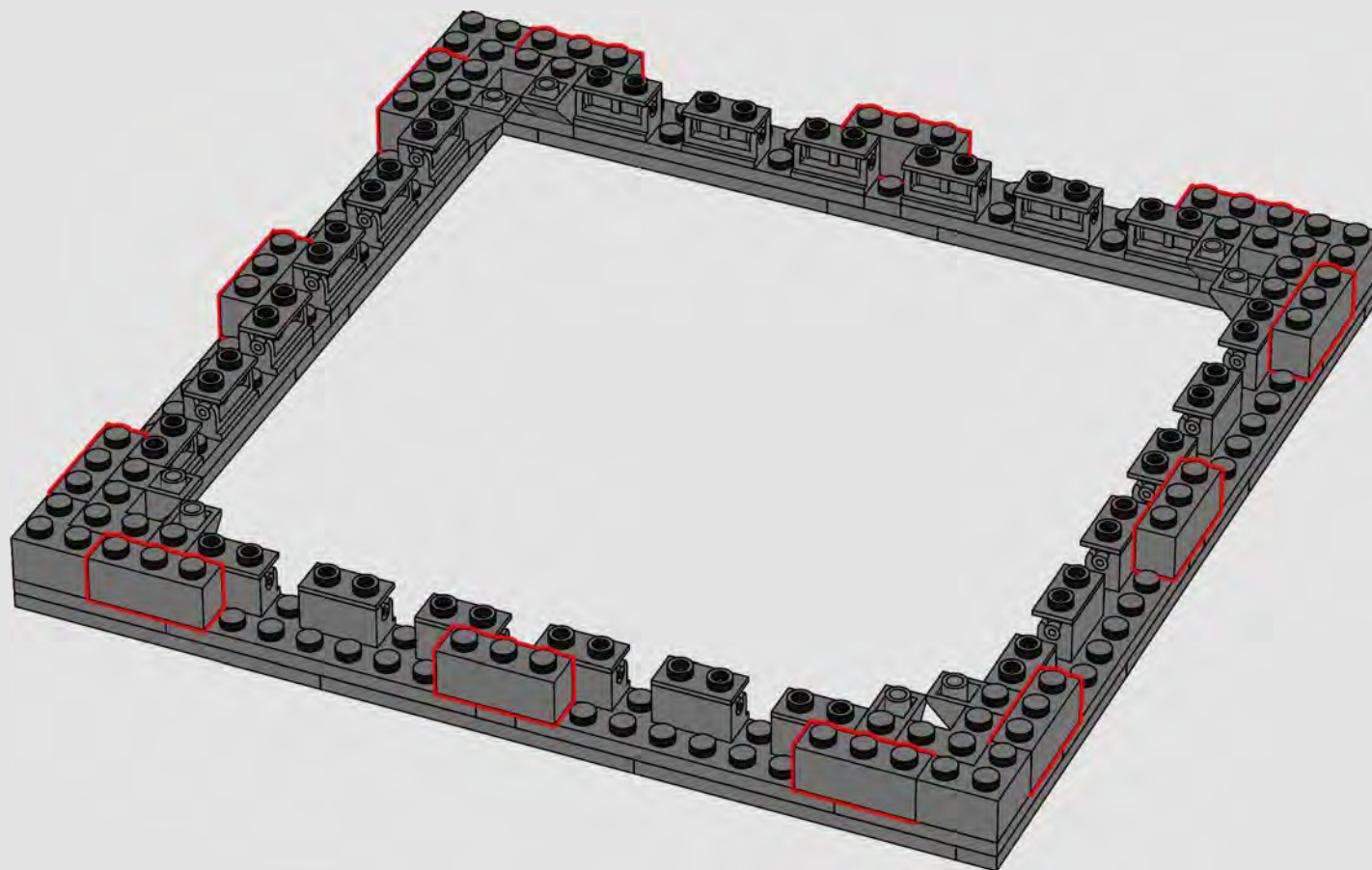

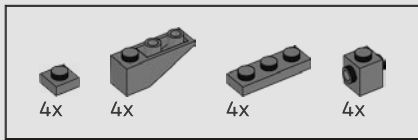

292

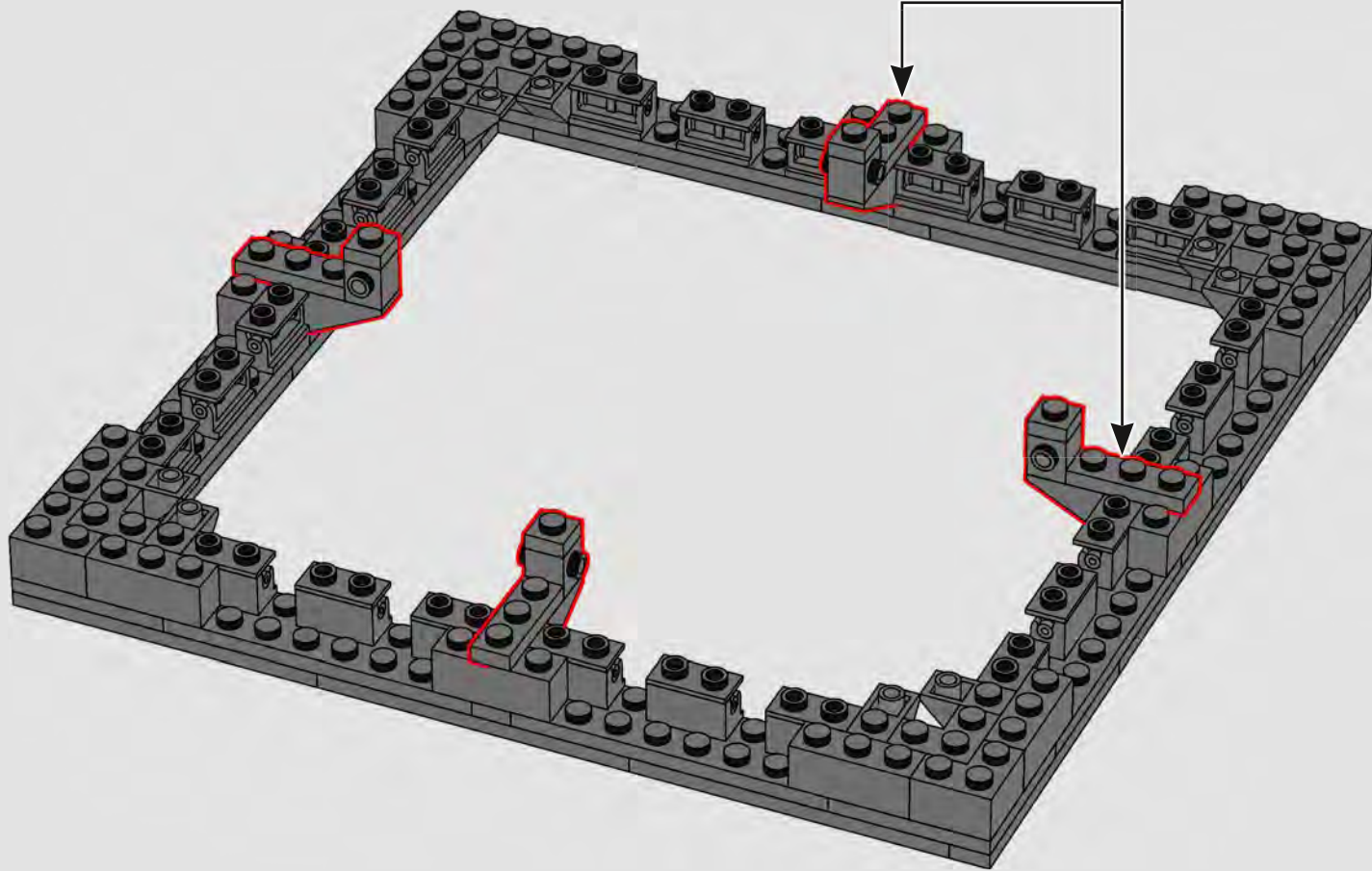
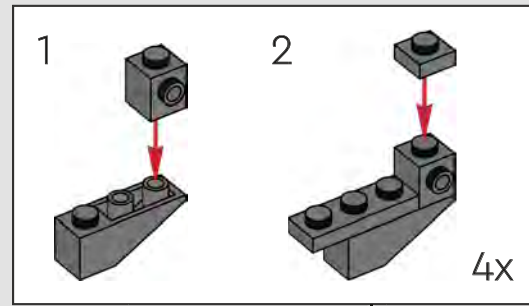

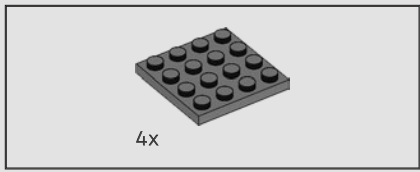

293

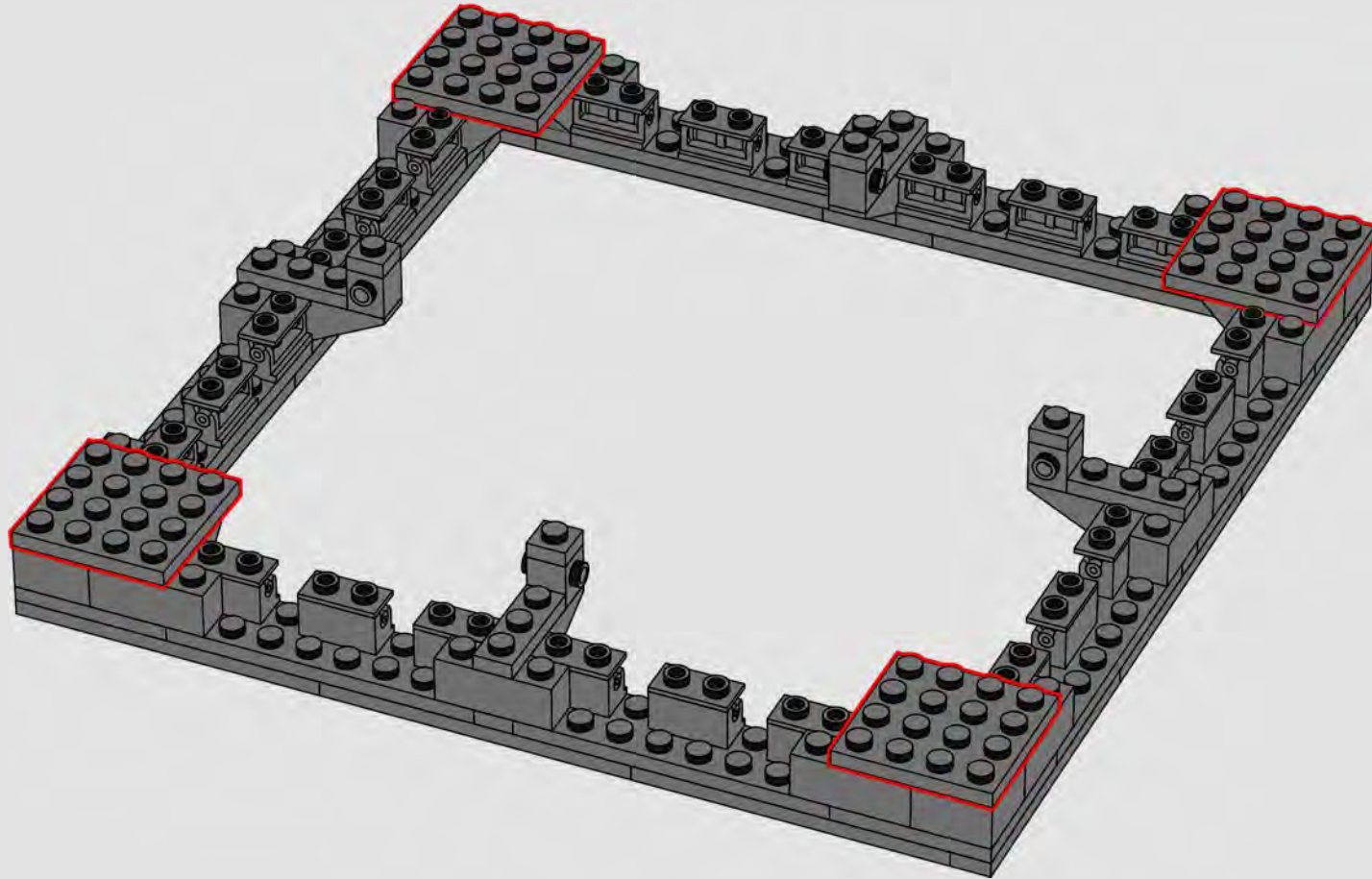

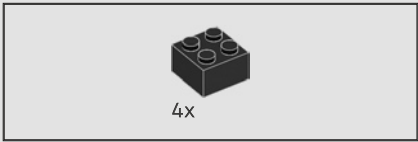

294

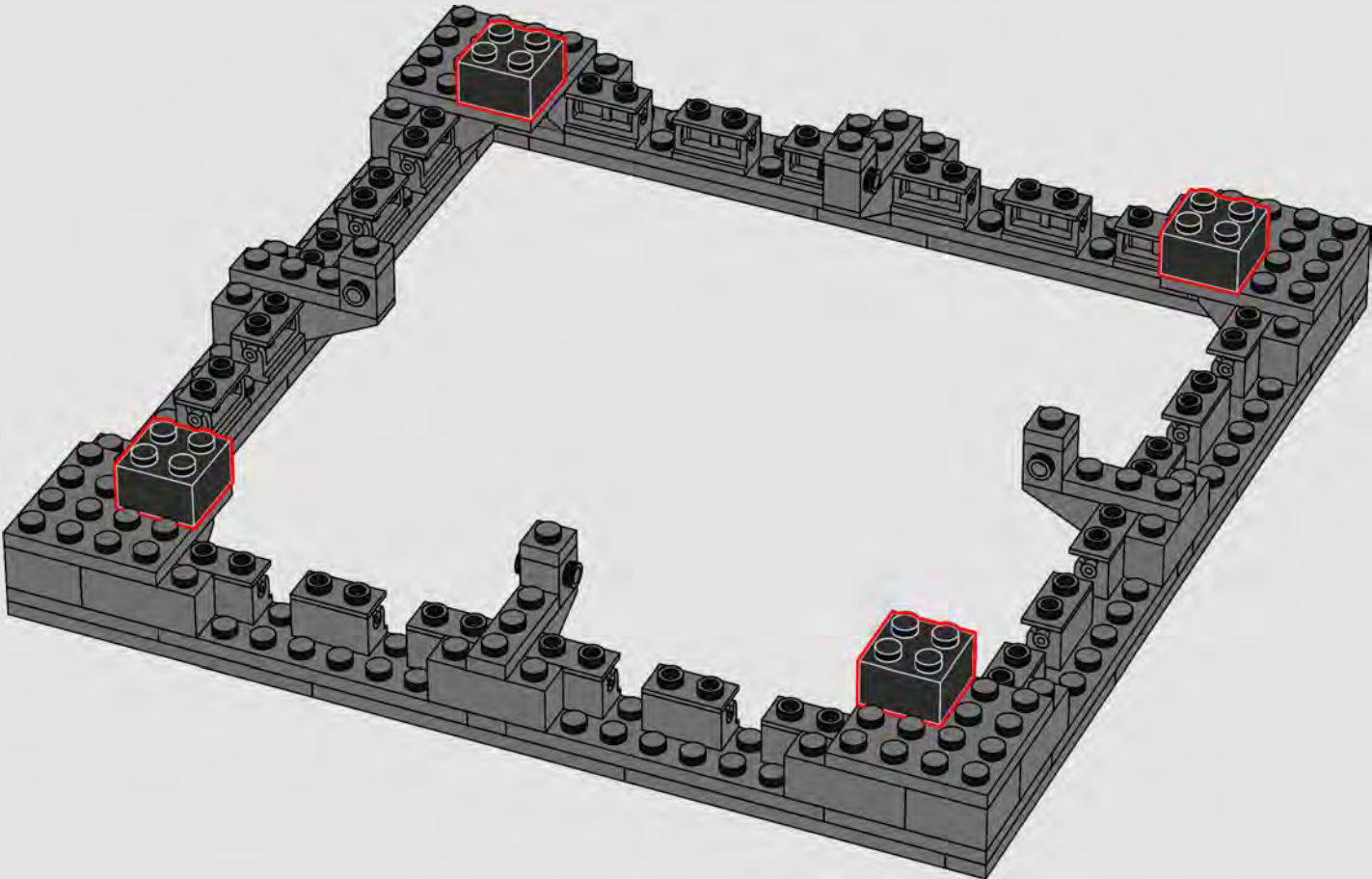

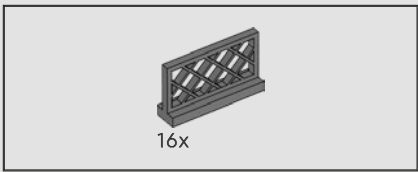

295

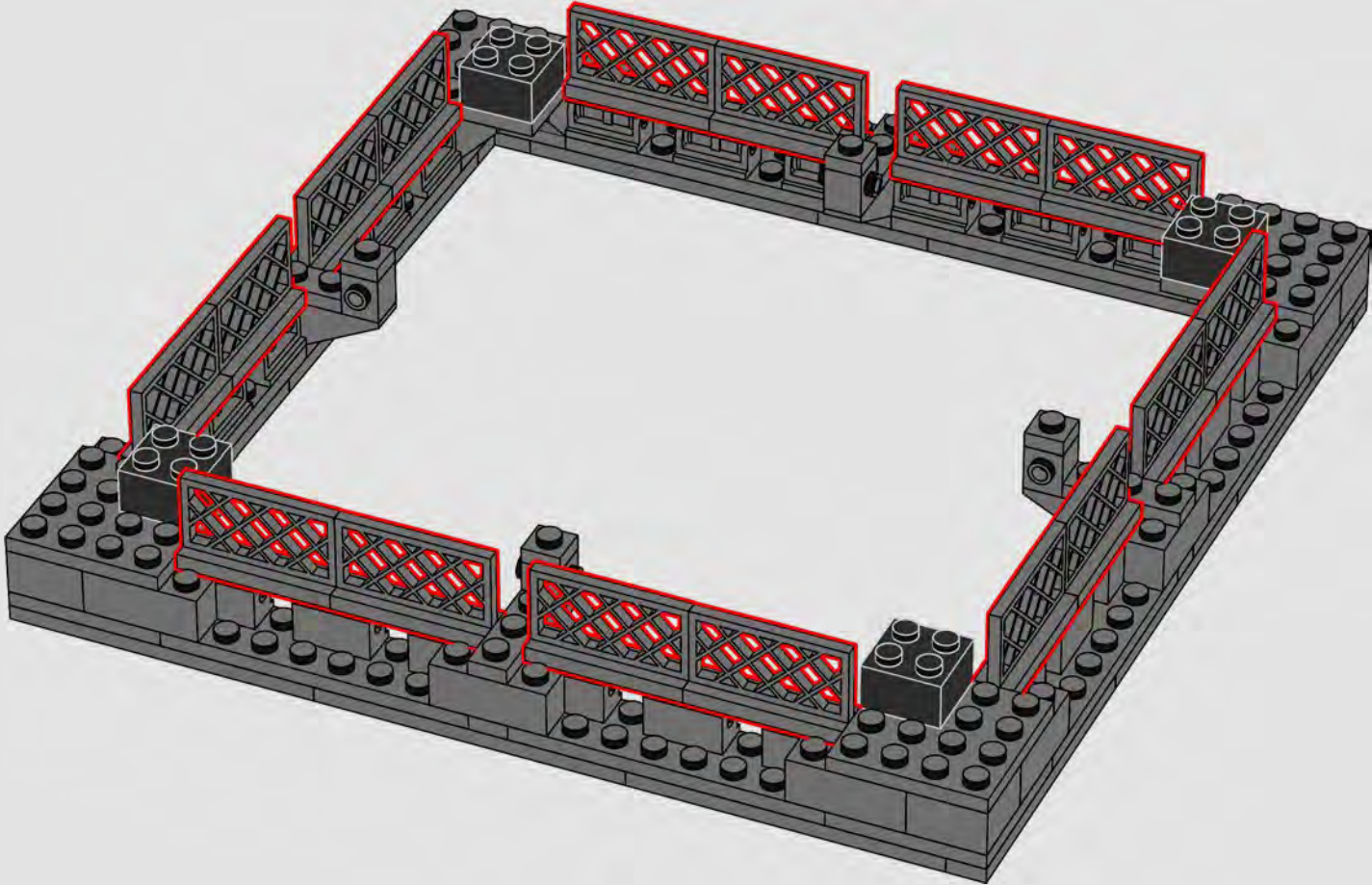

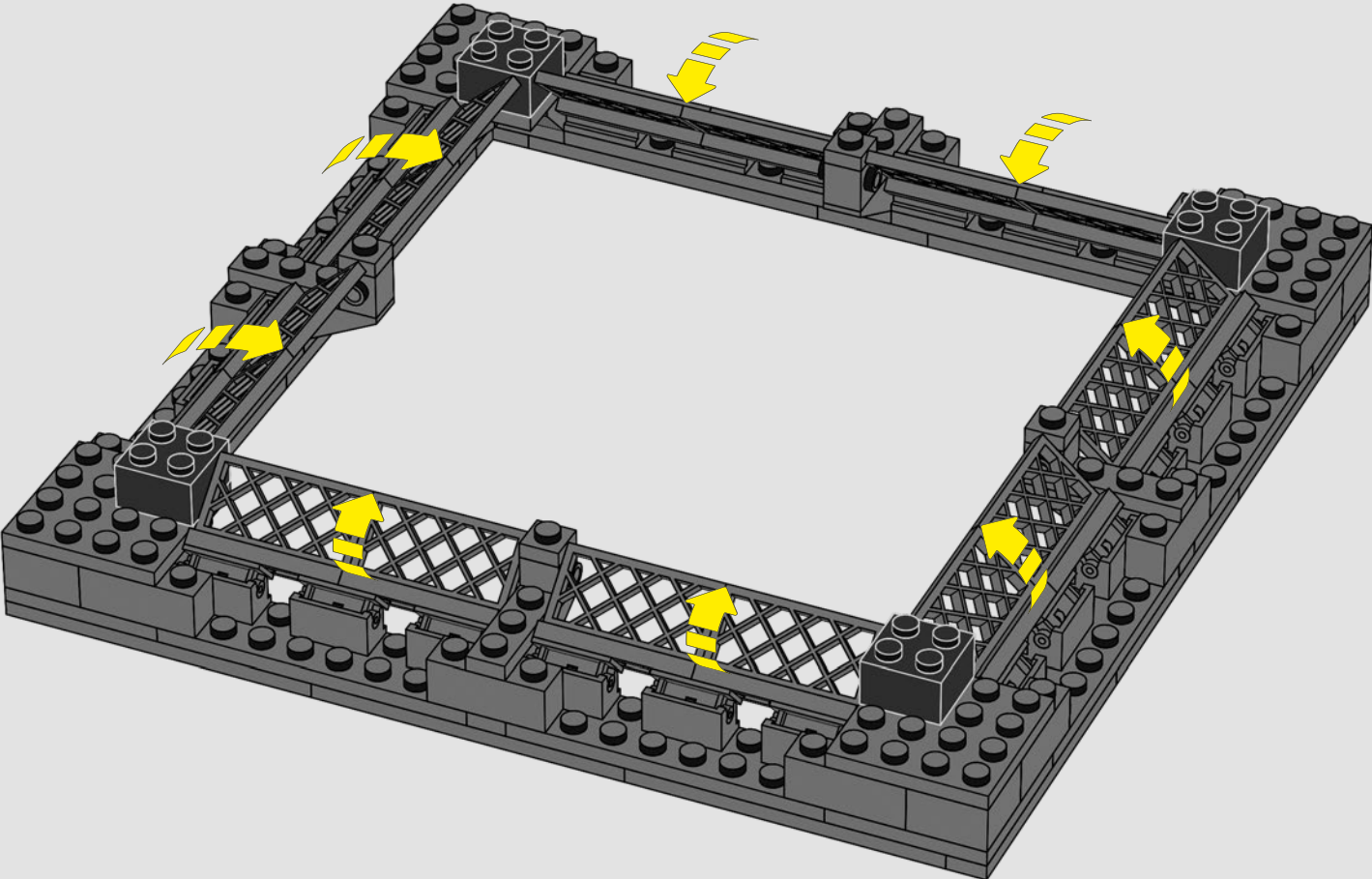

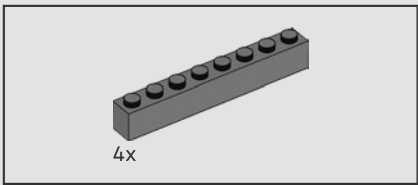

297

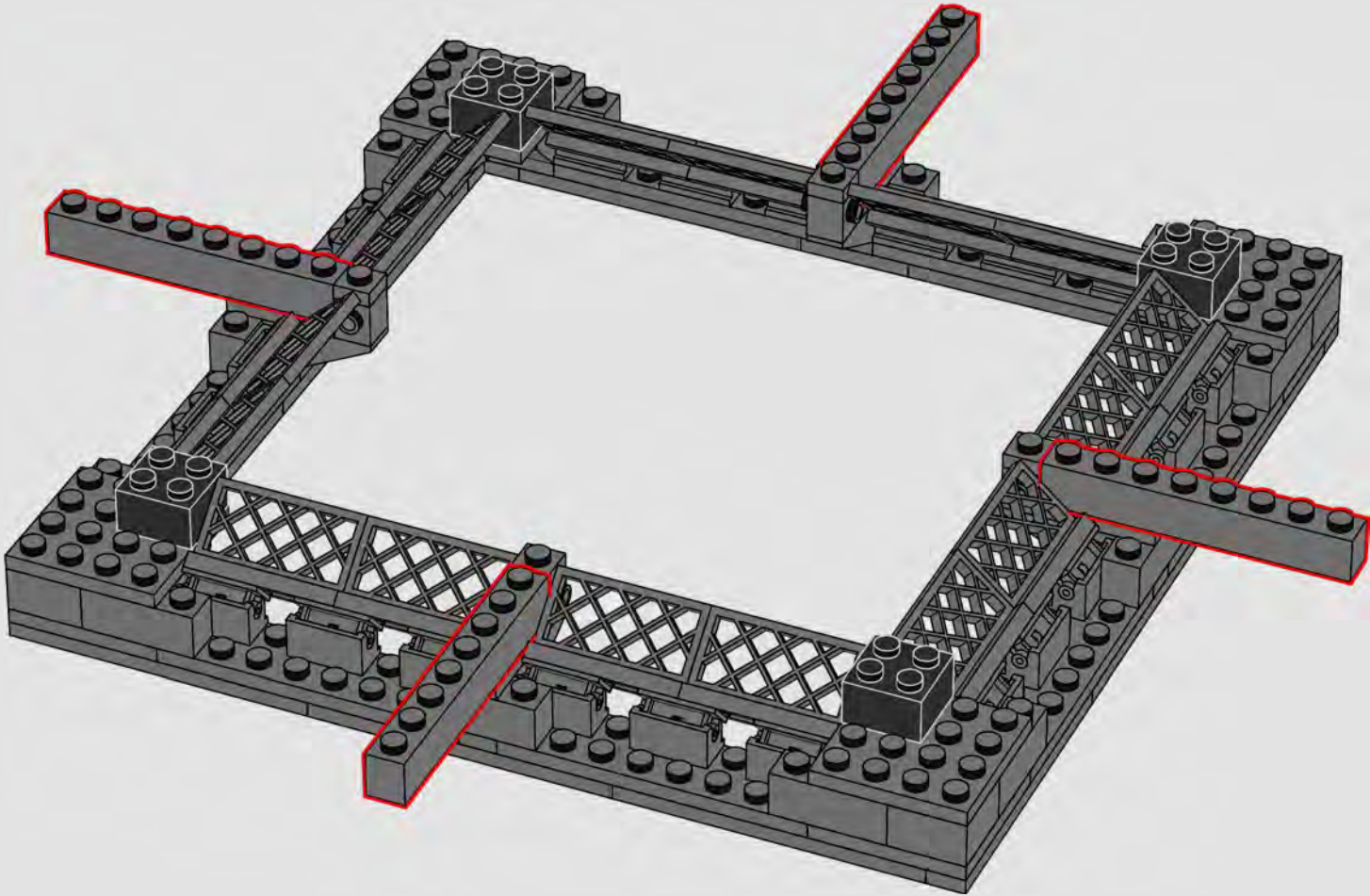

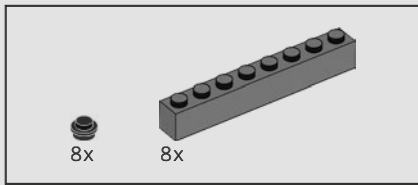

298

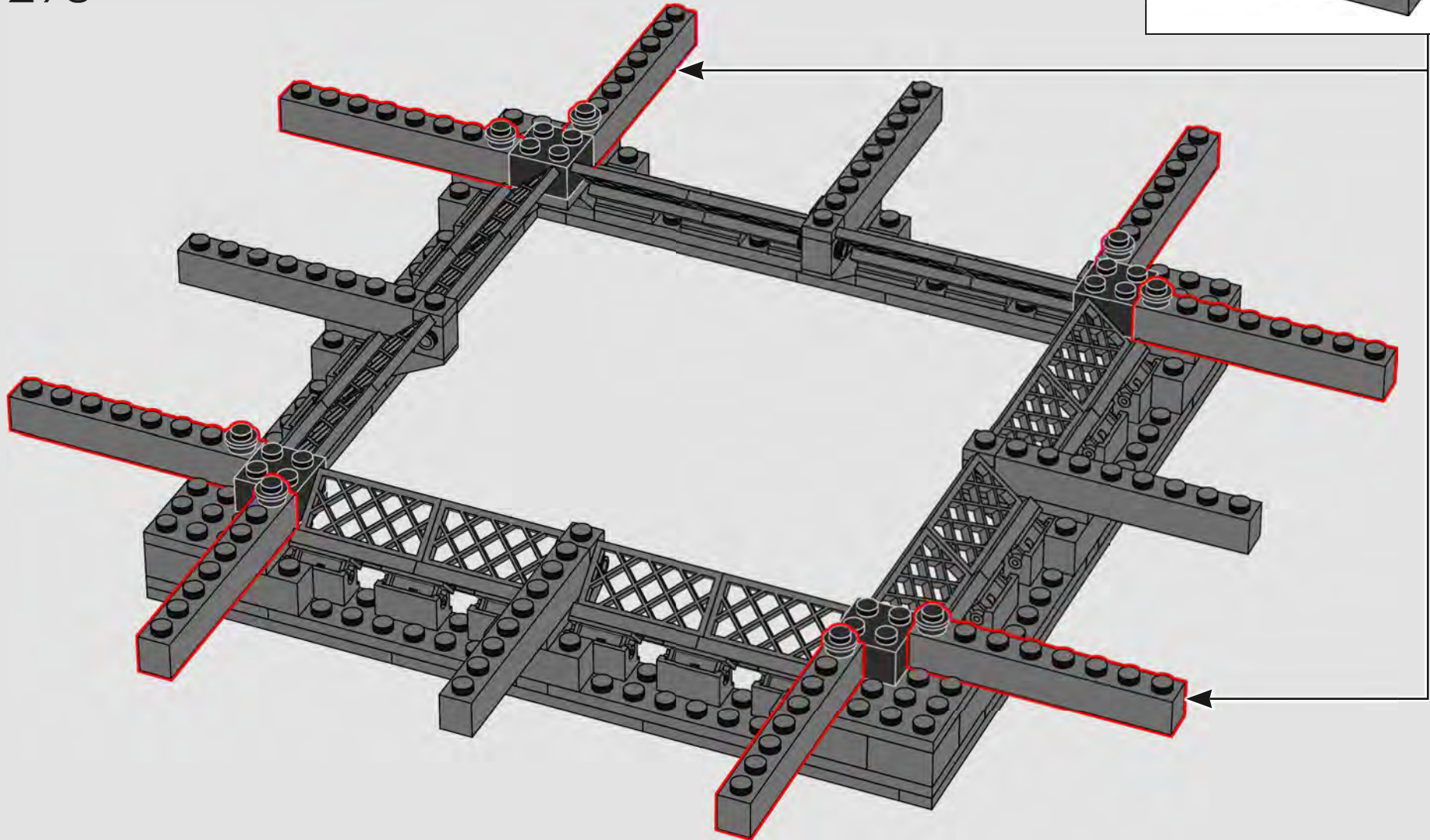
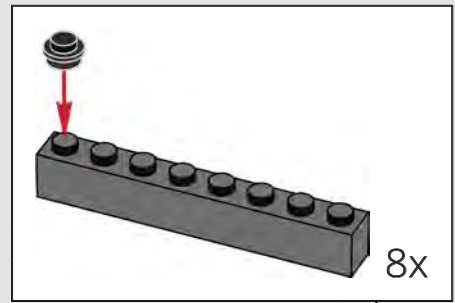

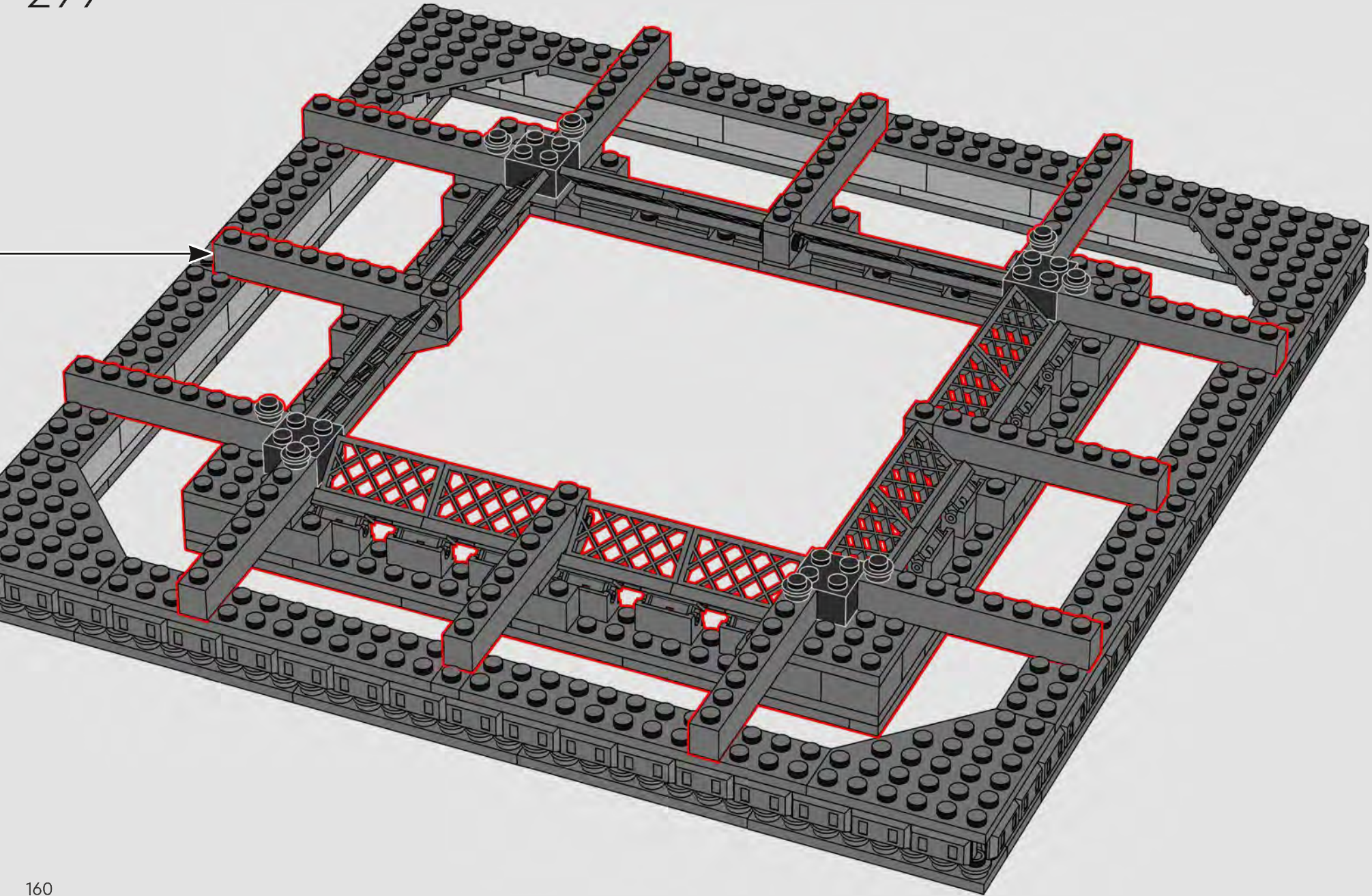

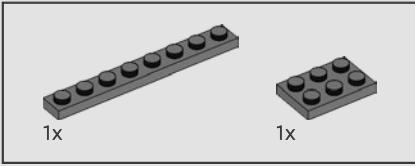
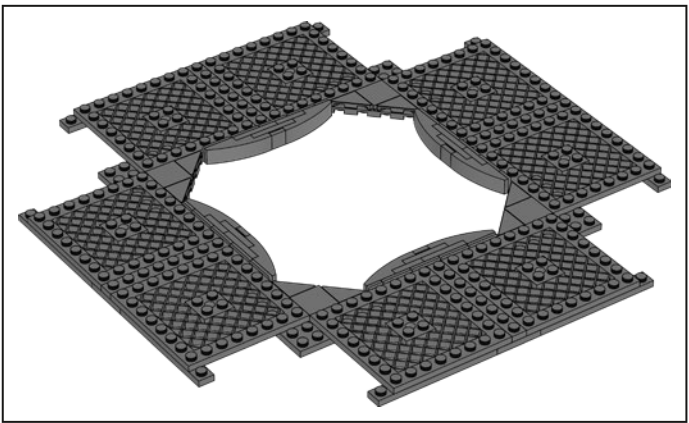
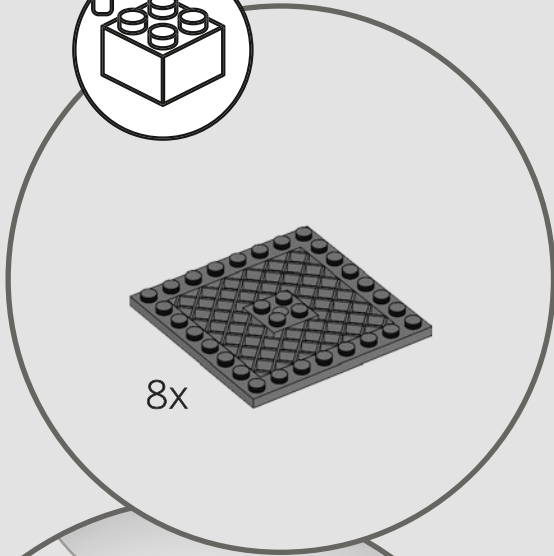
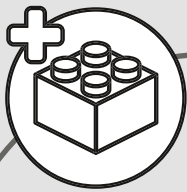

300

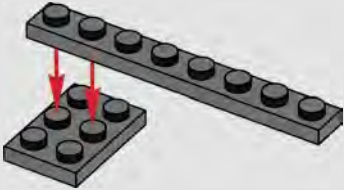

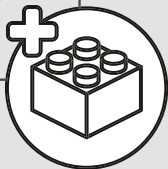
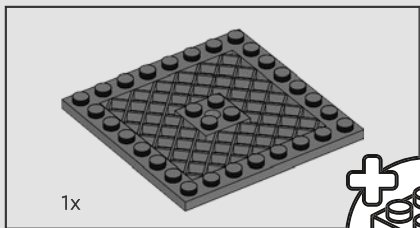

301

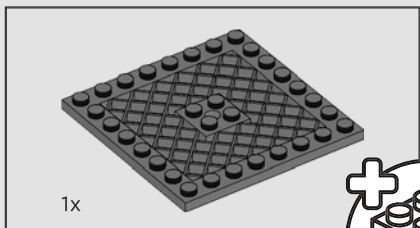
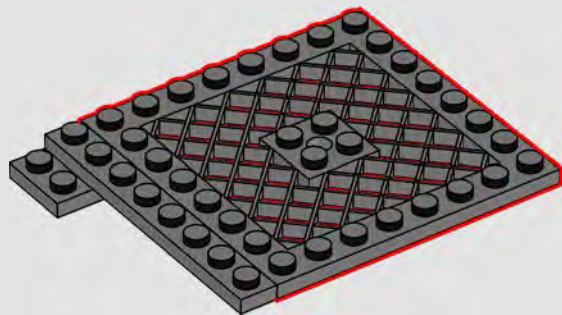

302

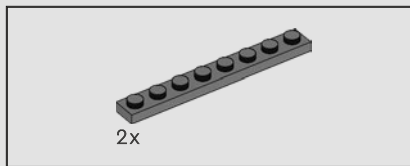
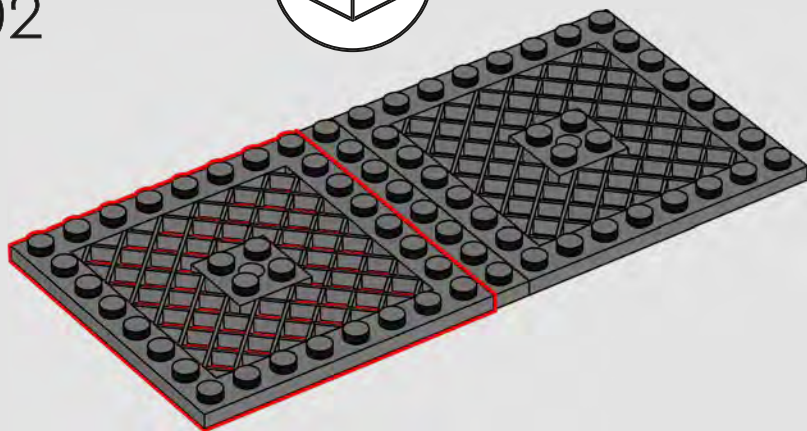

303

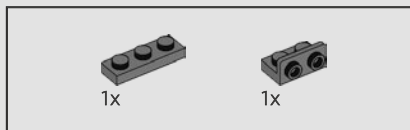
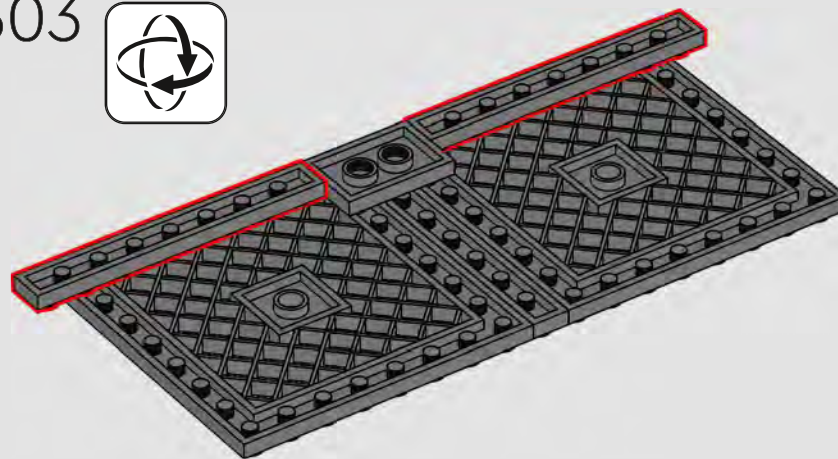

304

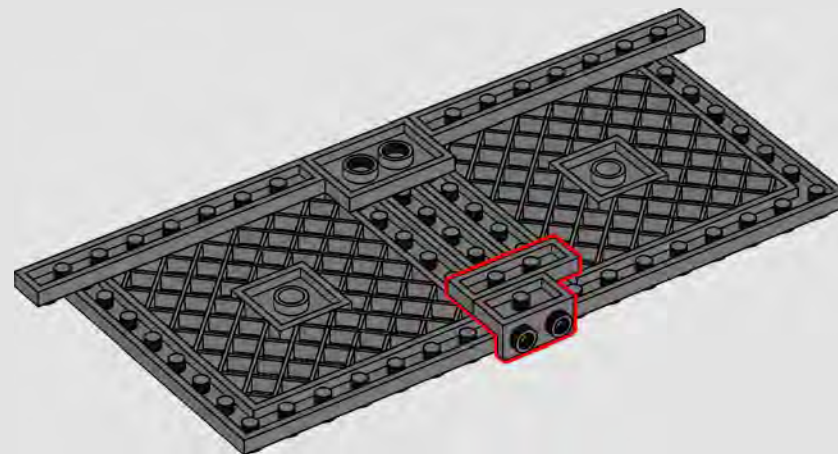

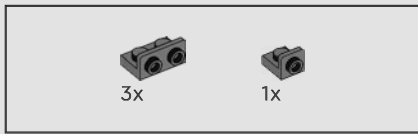

305

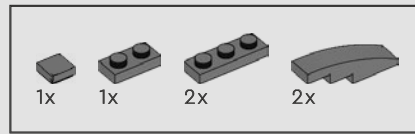
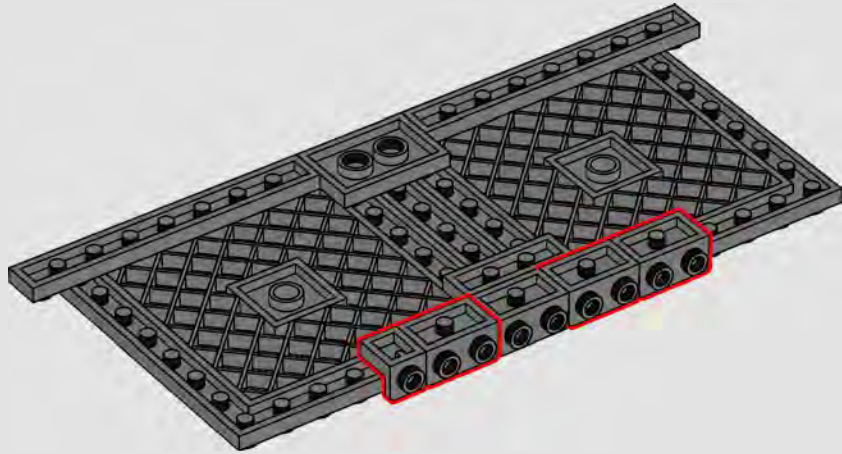

306

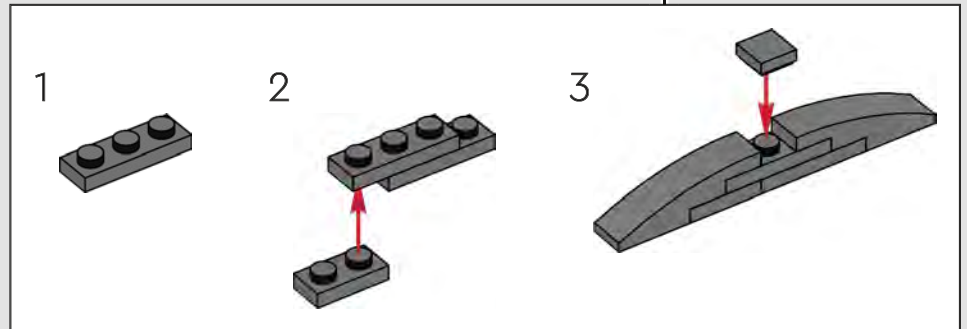
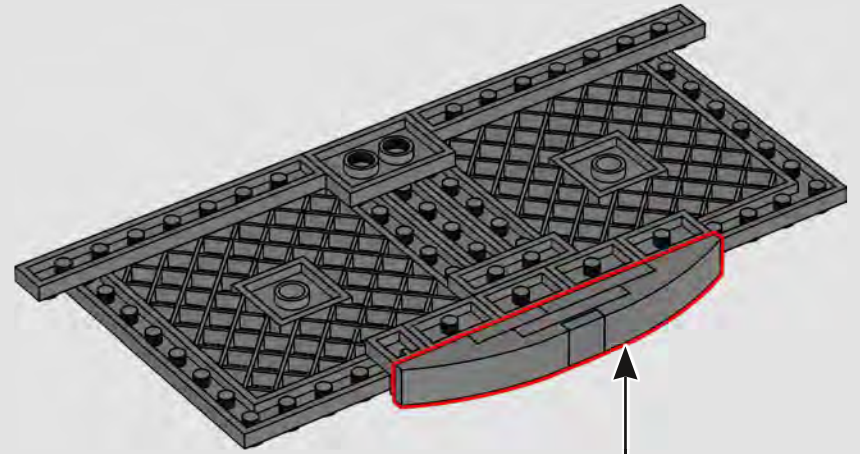

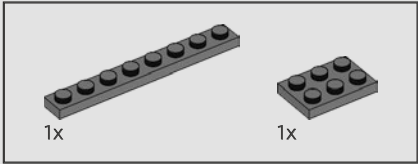
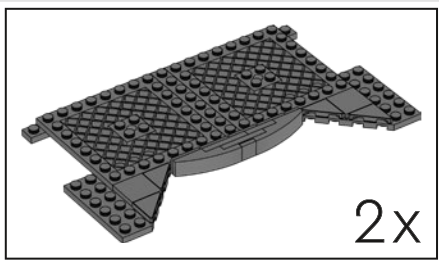

307

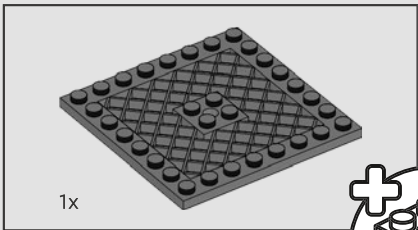
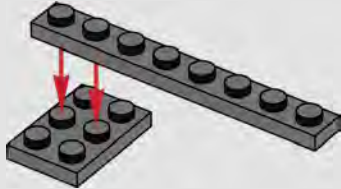

308

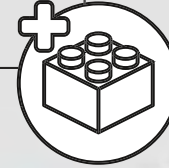
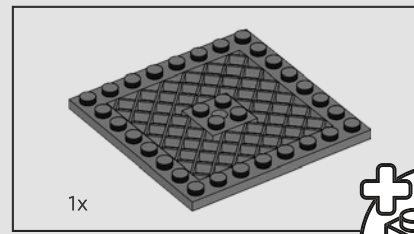
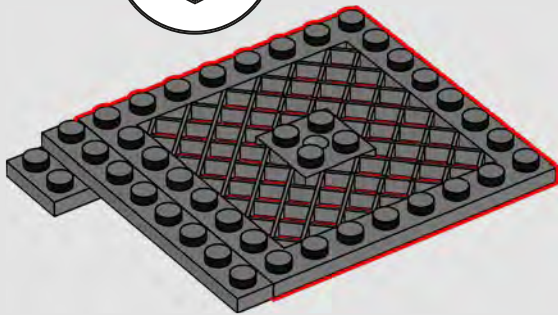

309

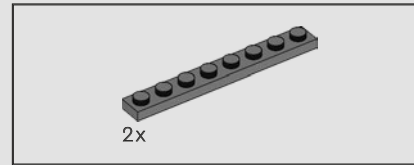
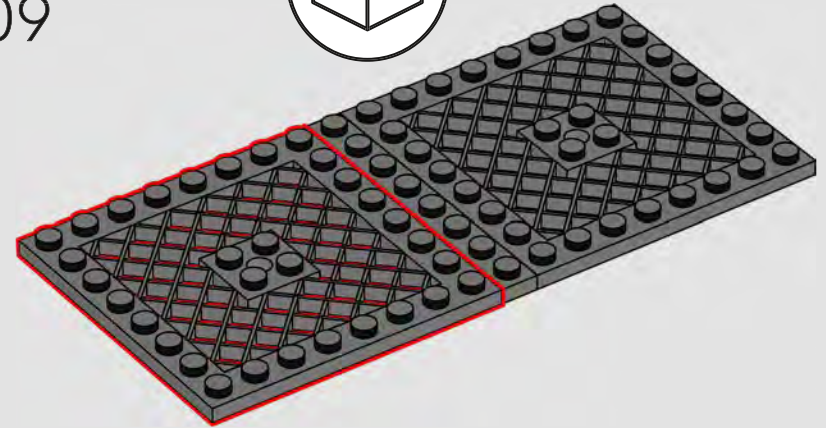

310

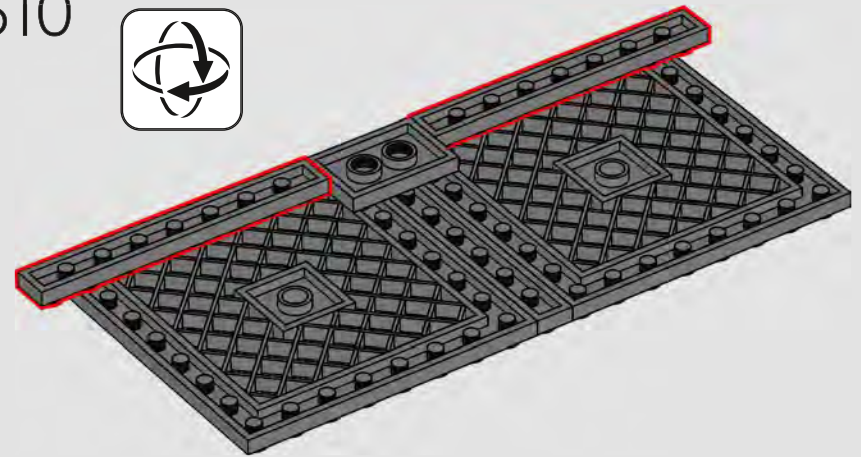

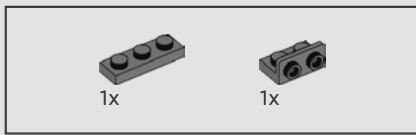

311

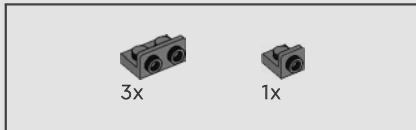
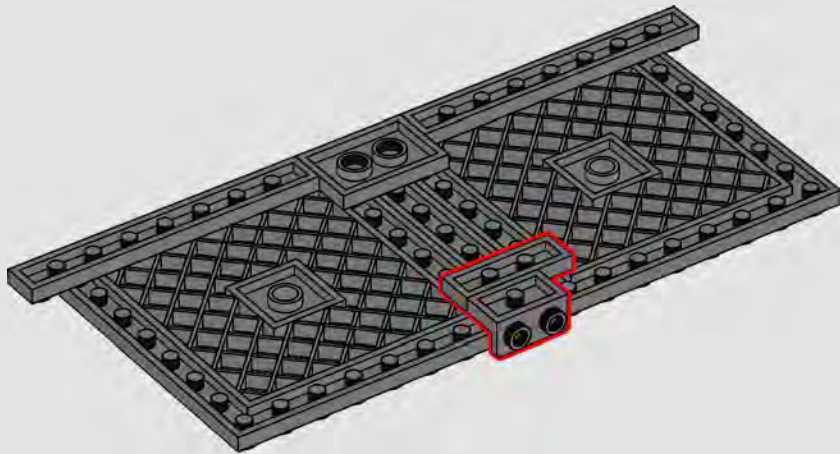

312

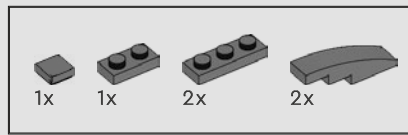
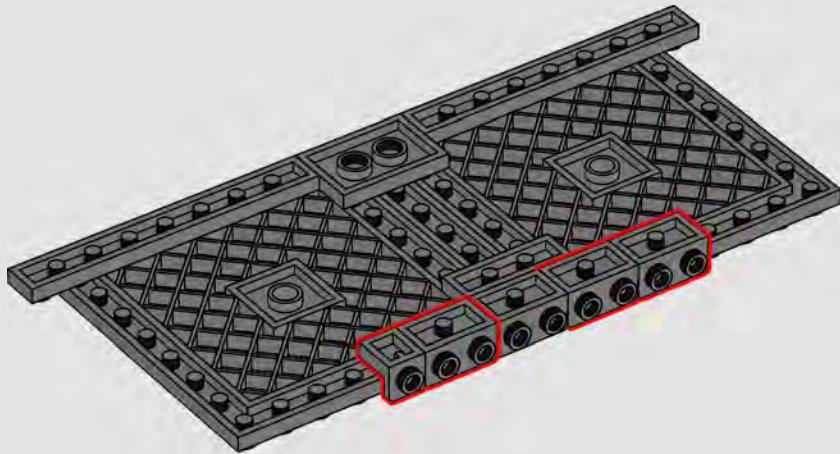

313

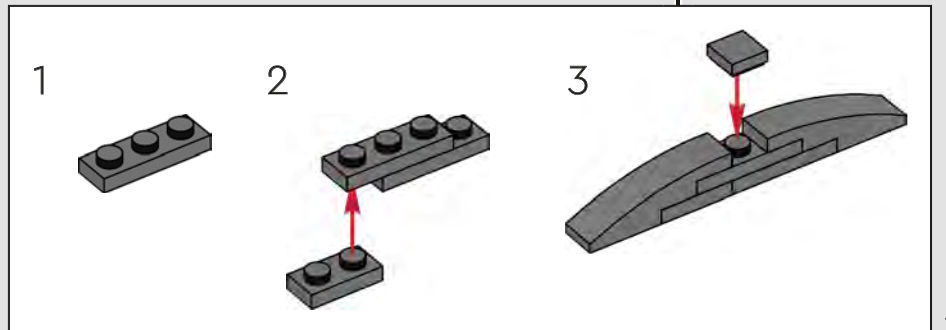
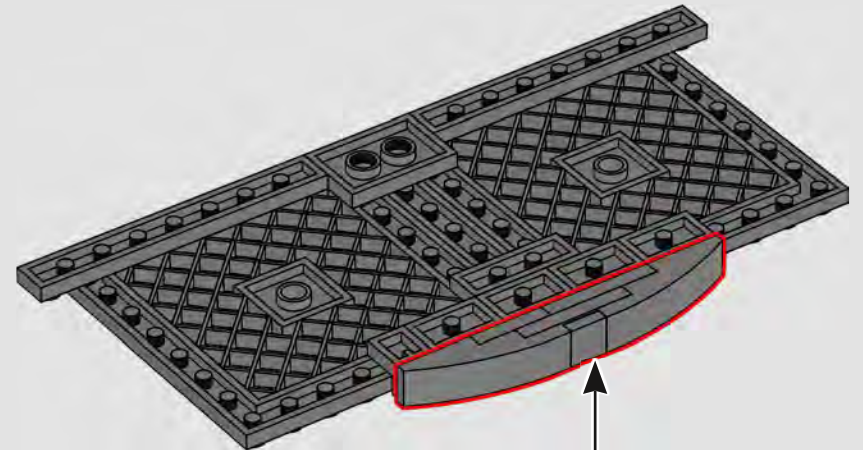

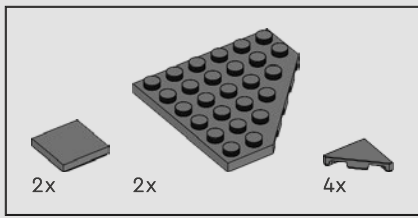

314

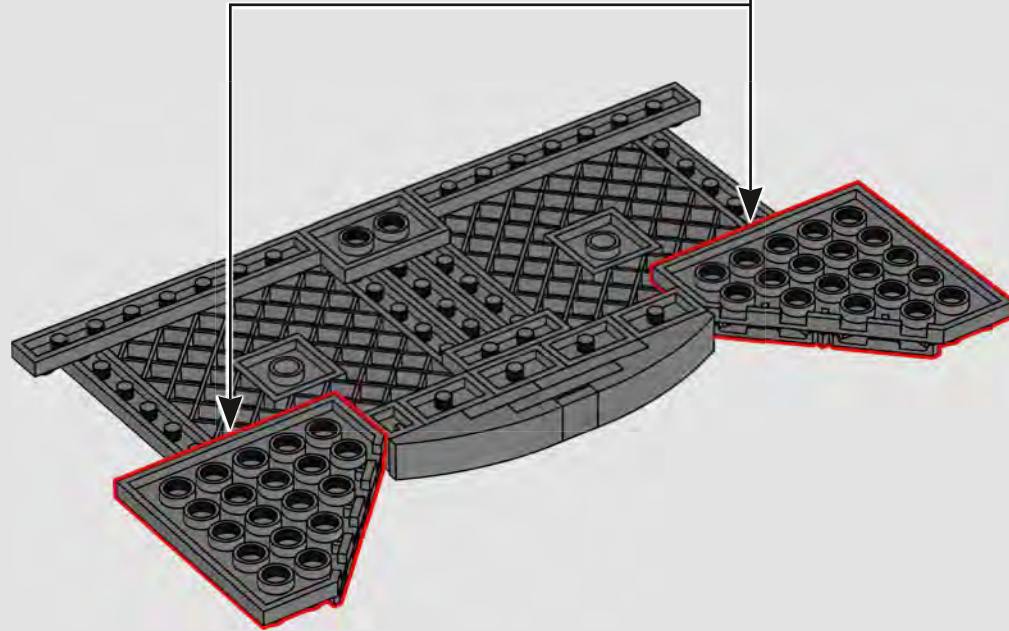
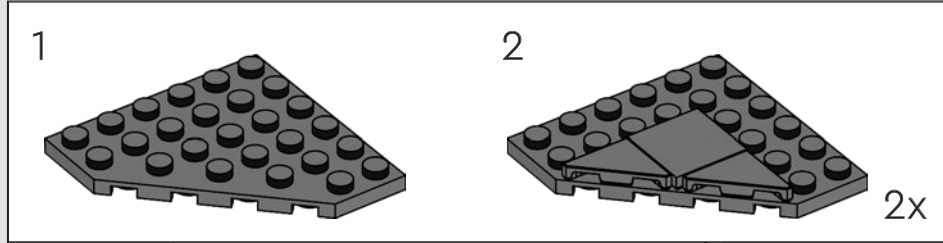

315

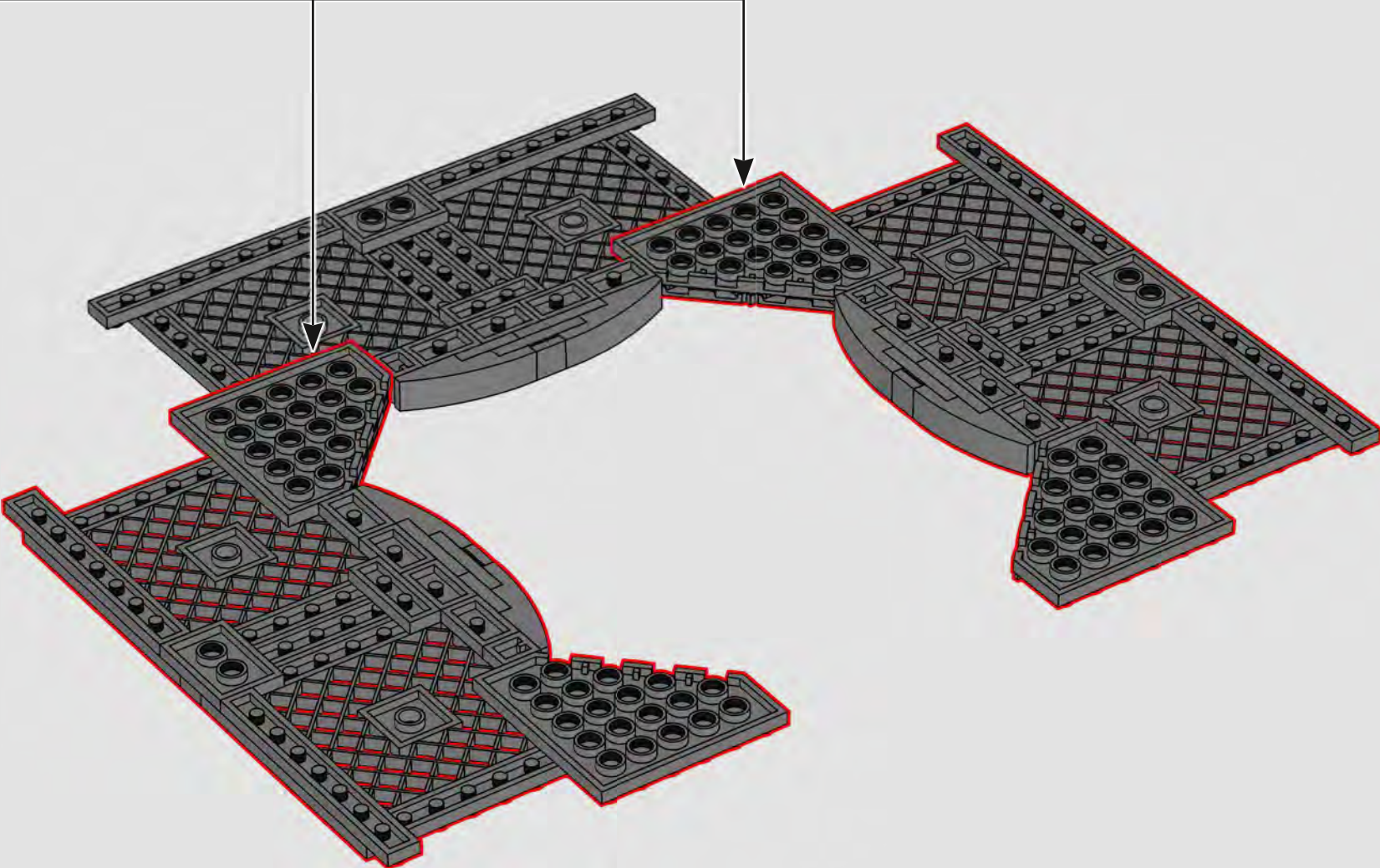

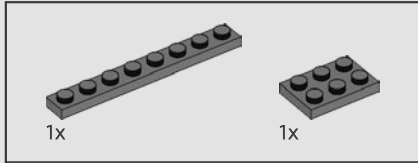
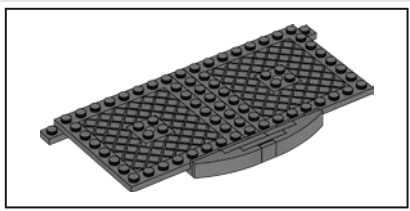

316

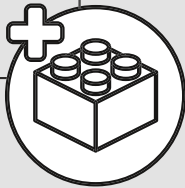
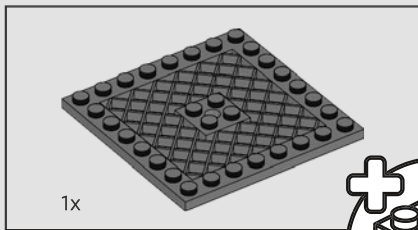
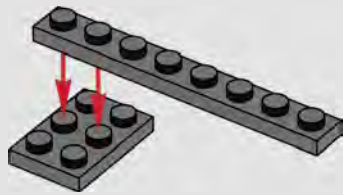

317

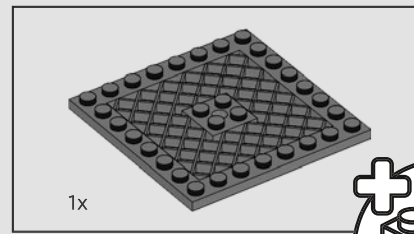
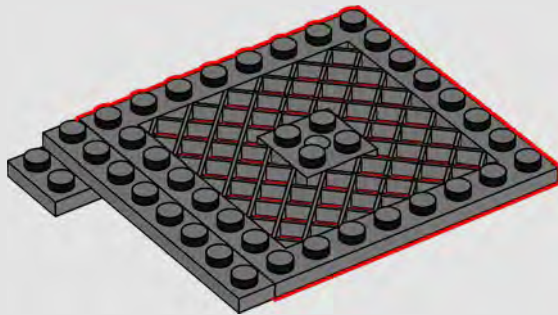

1x

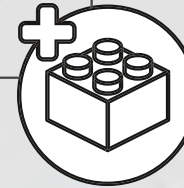

318

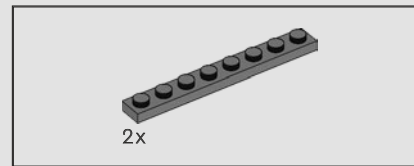
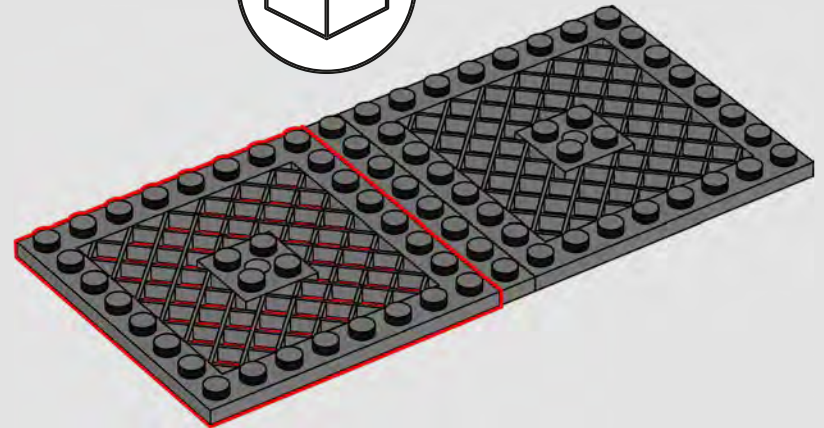

2x



319

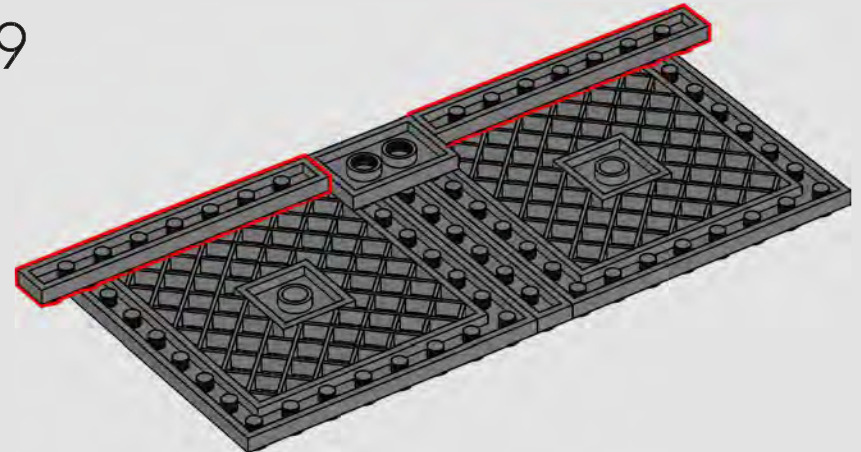

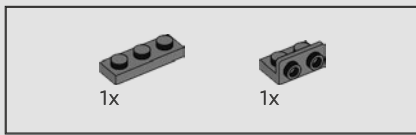

320

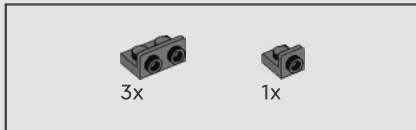
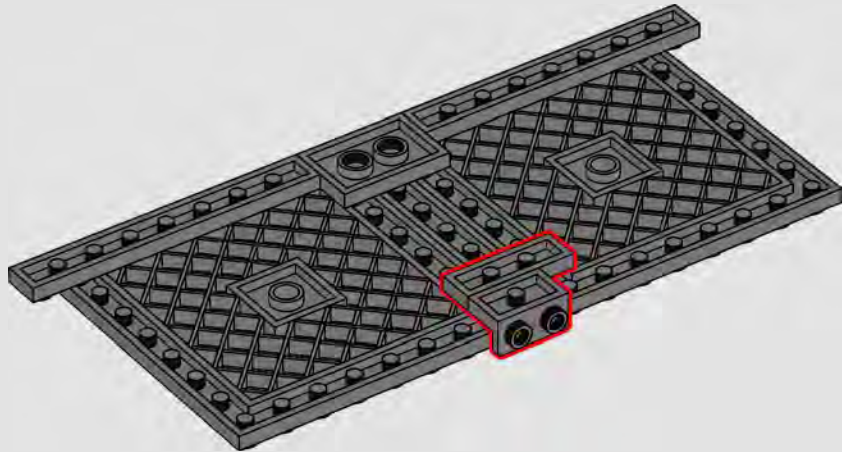

321

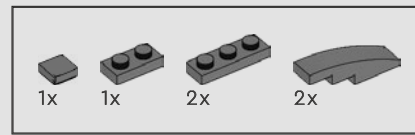
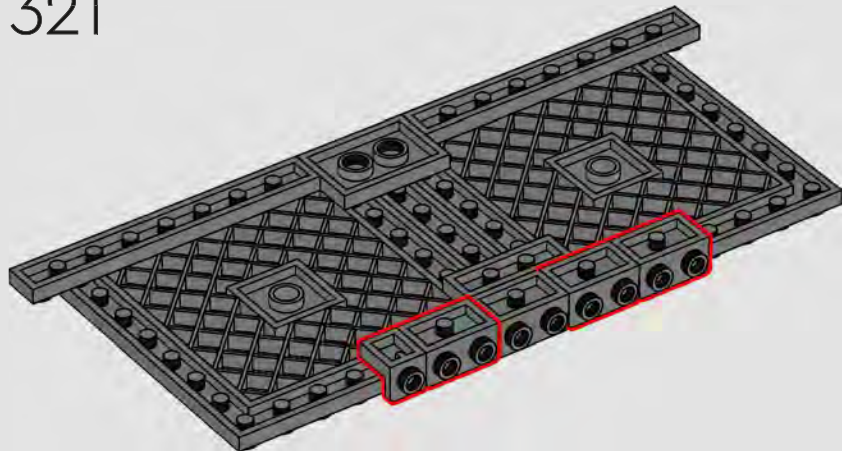

322

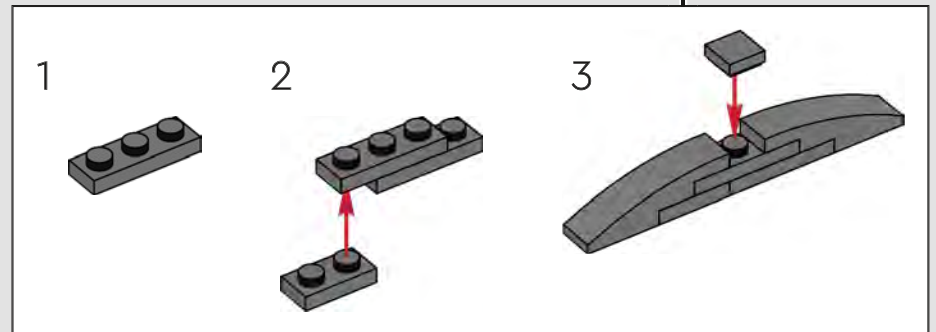
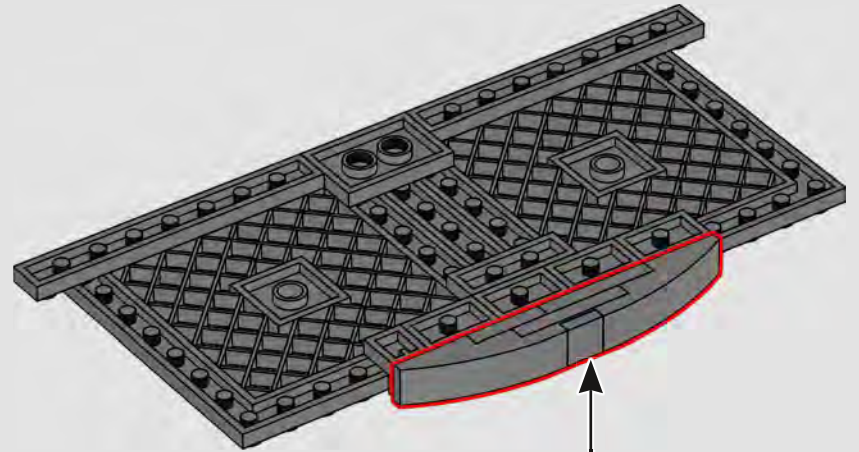

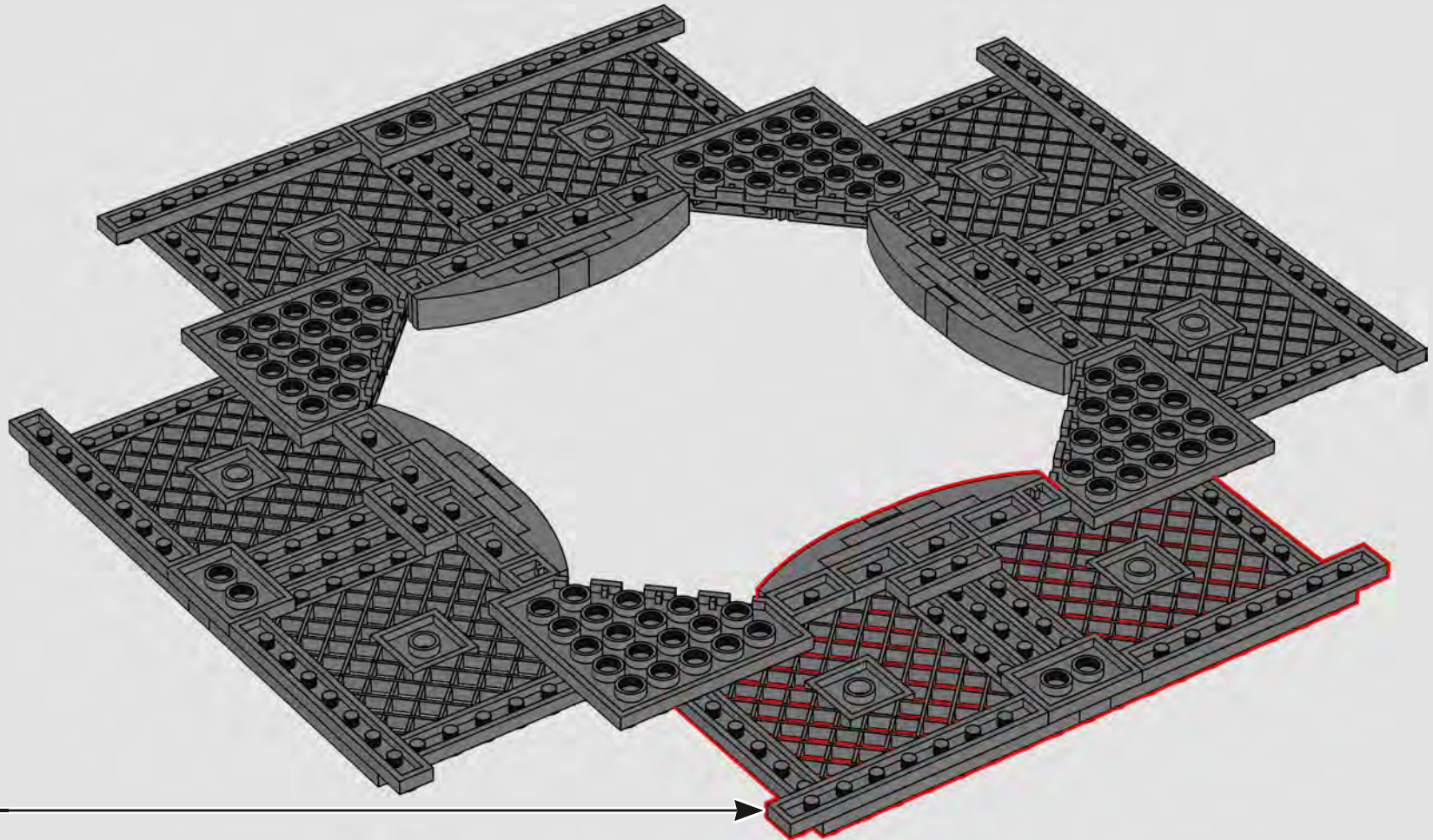

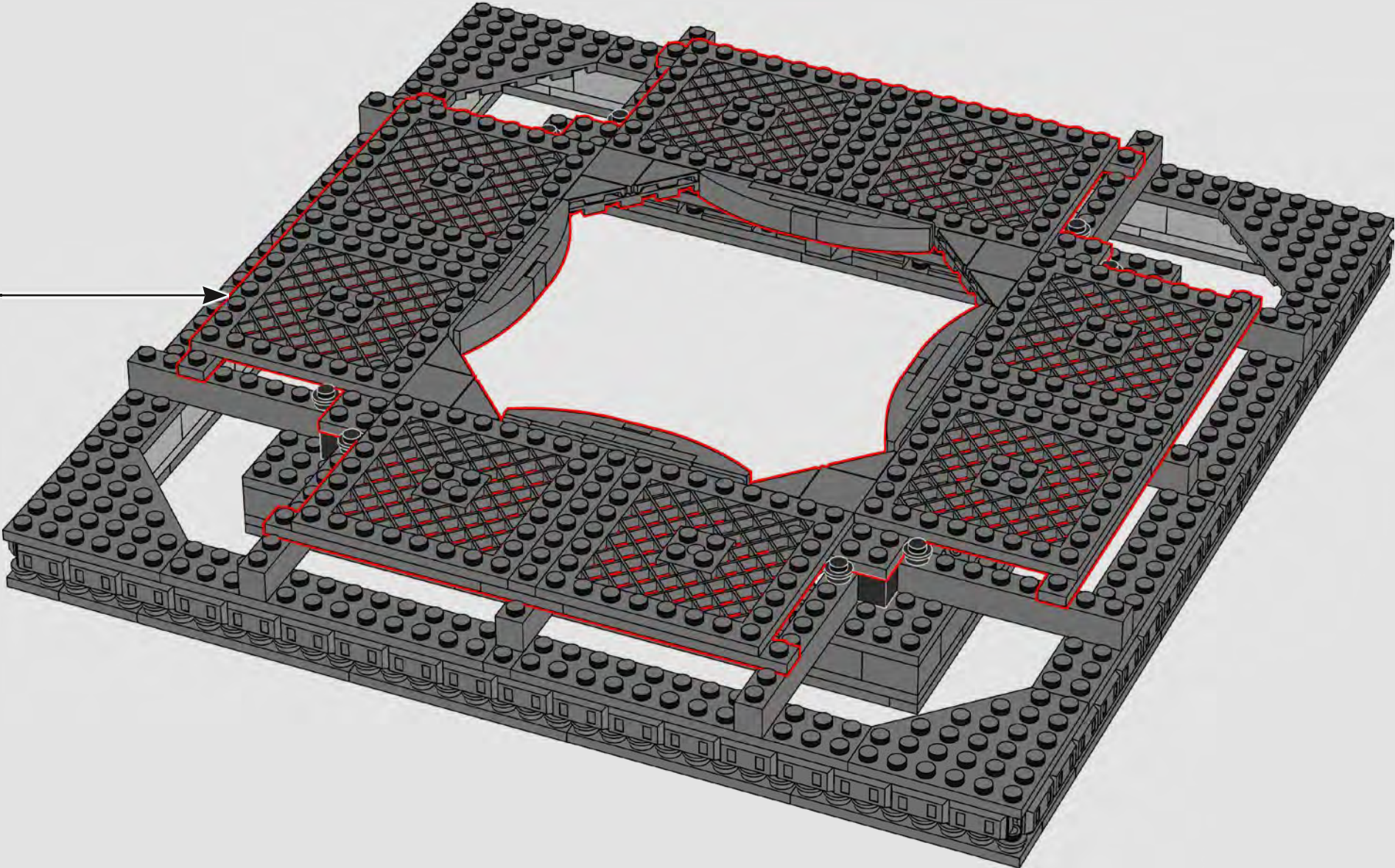





325

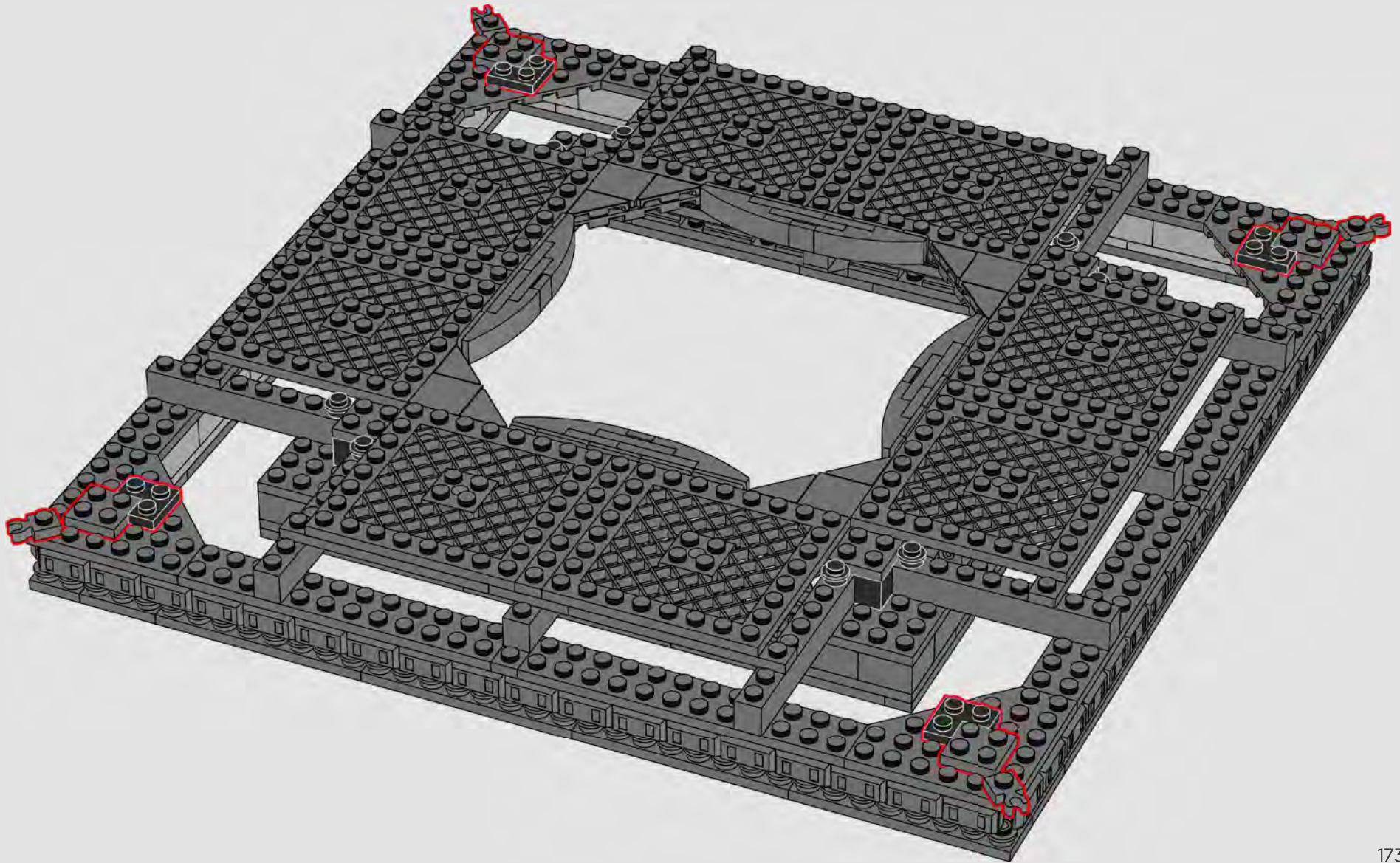

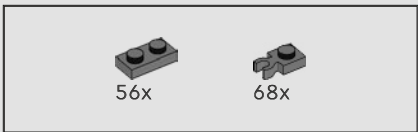

326

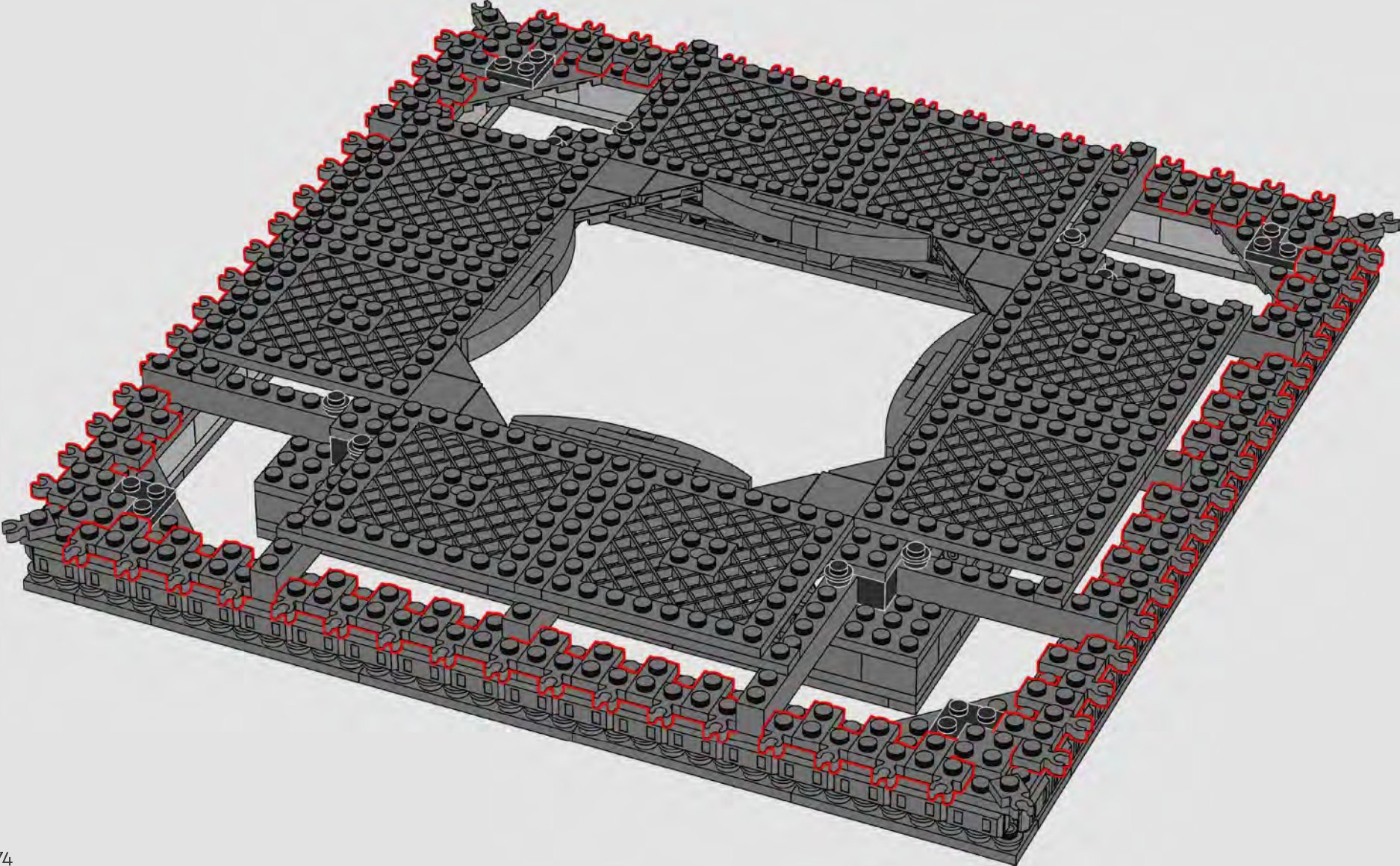

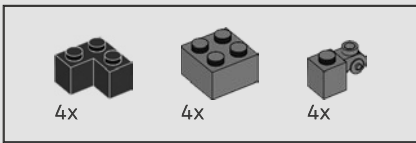

327

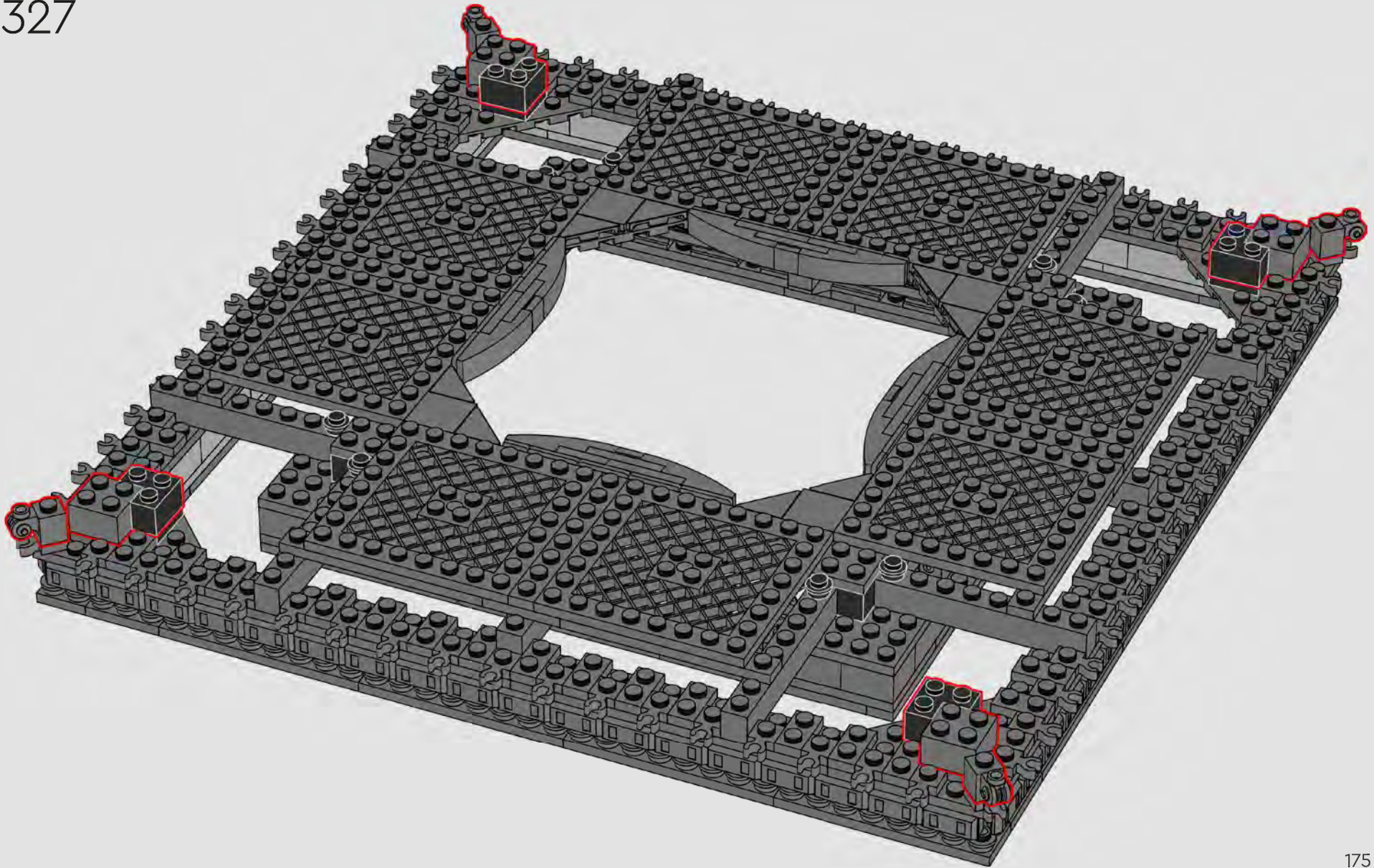



56x

328

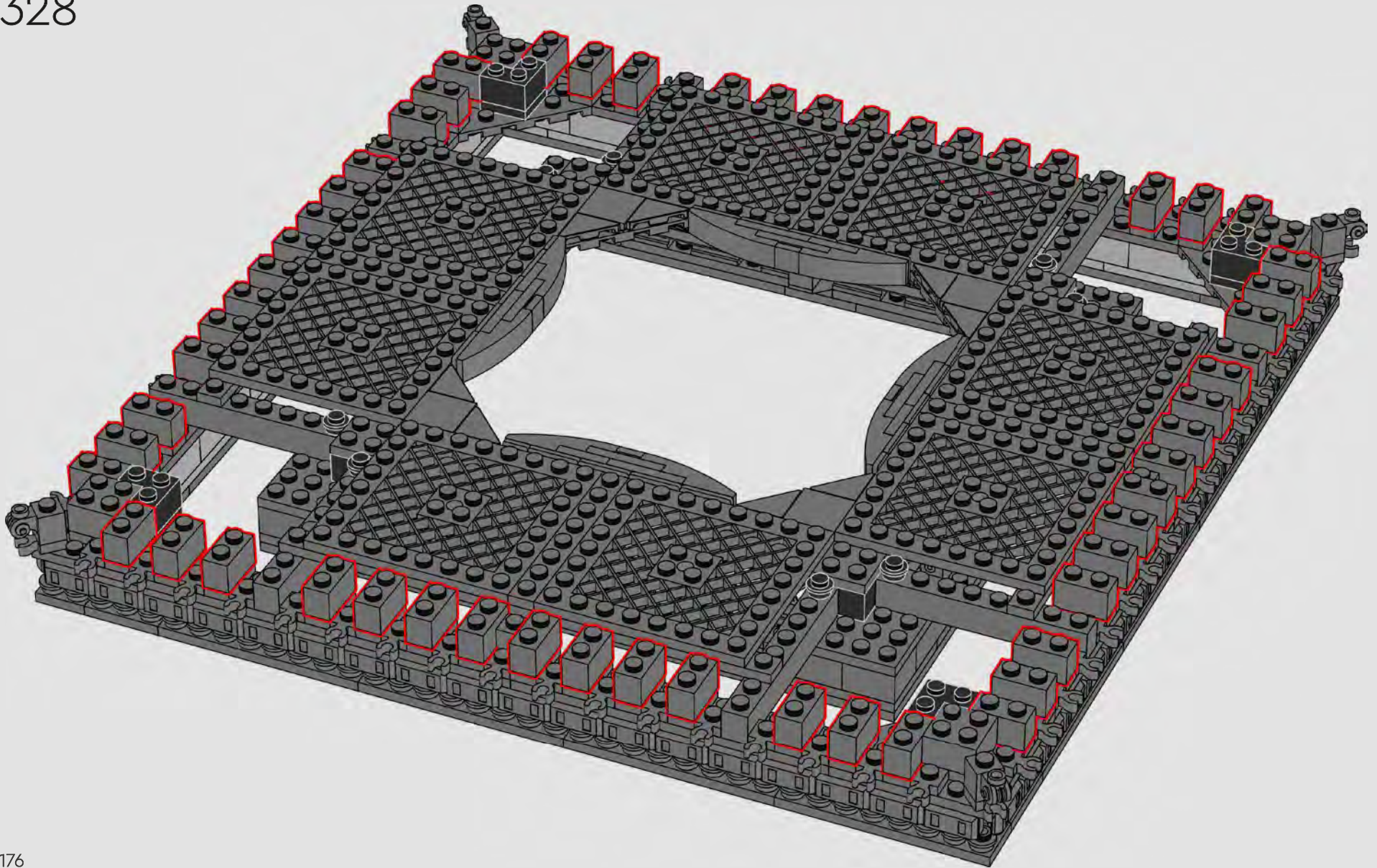



329

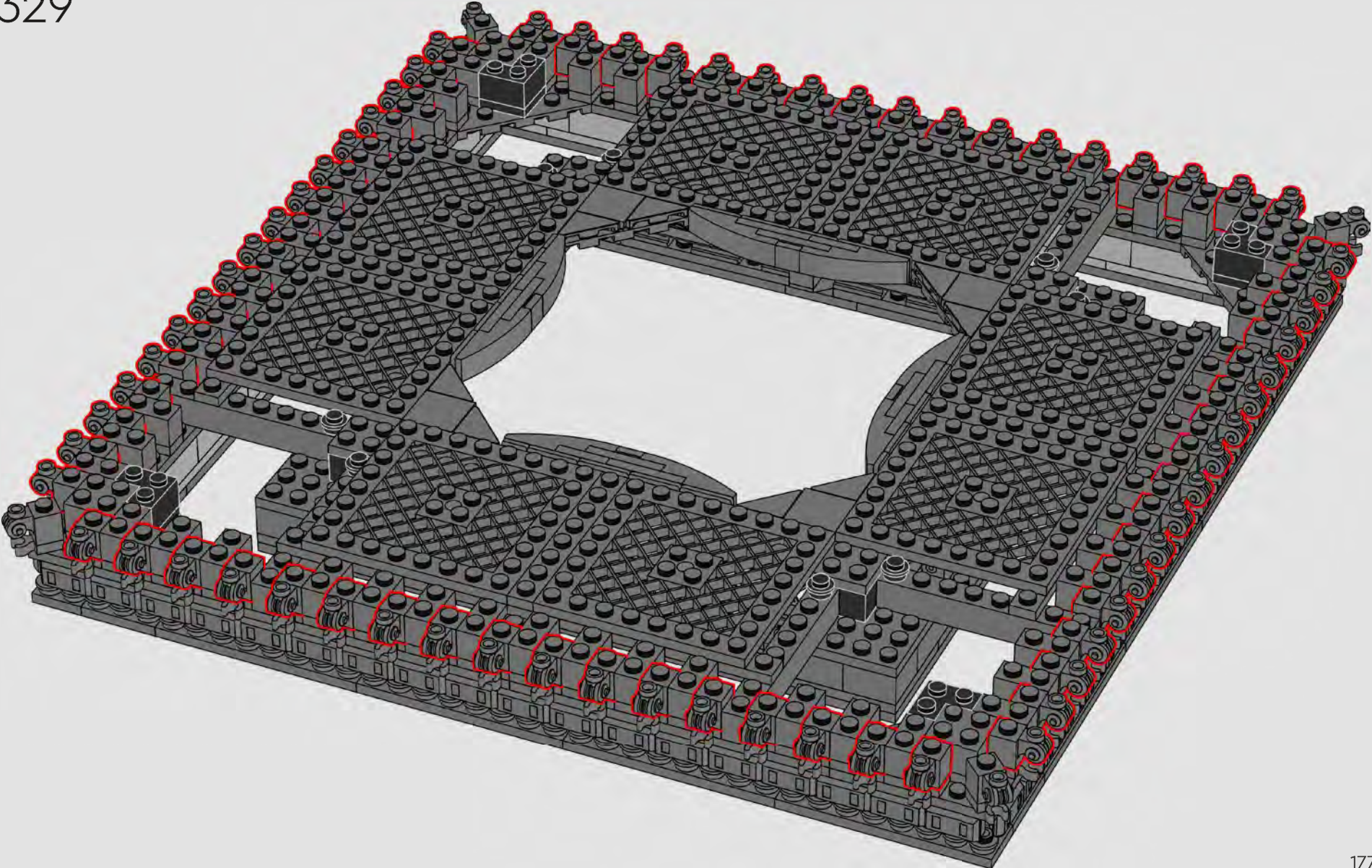



8x

330

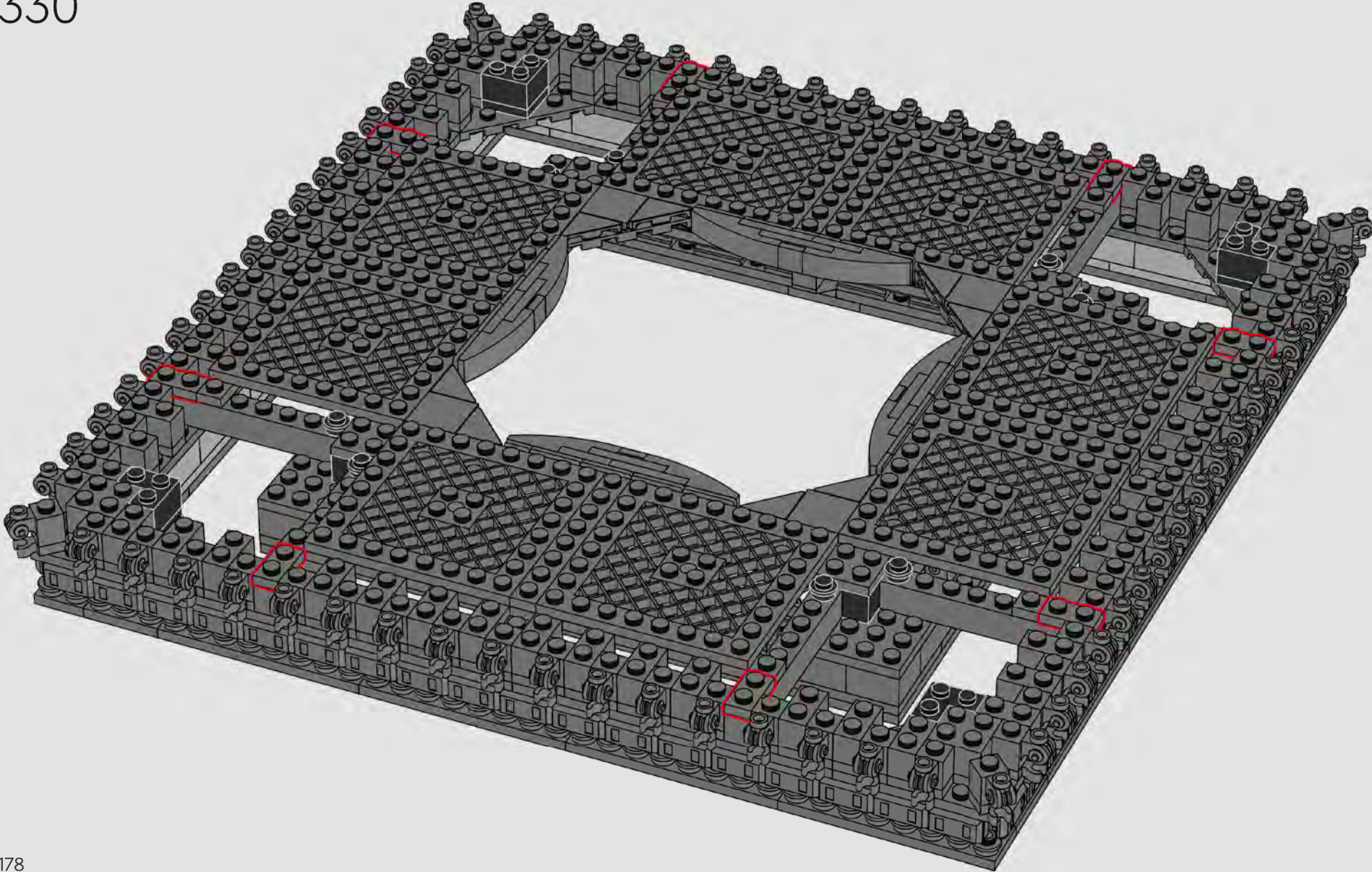





4x

331

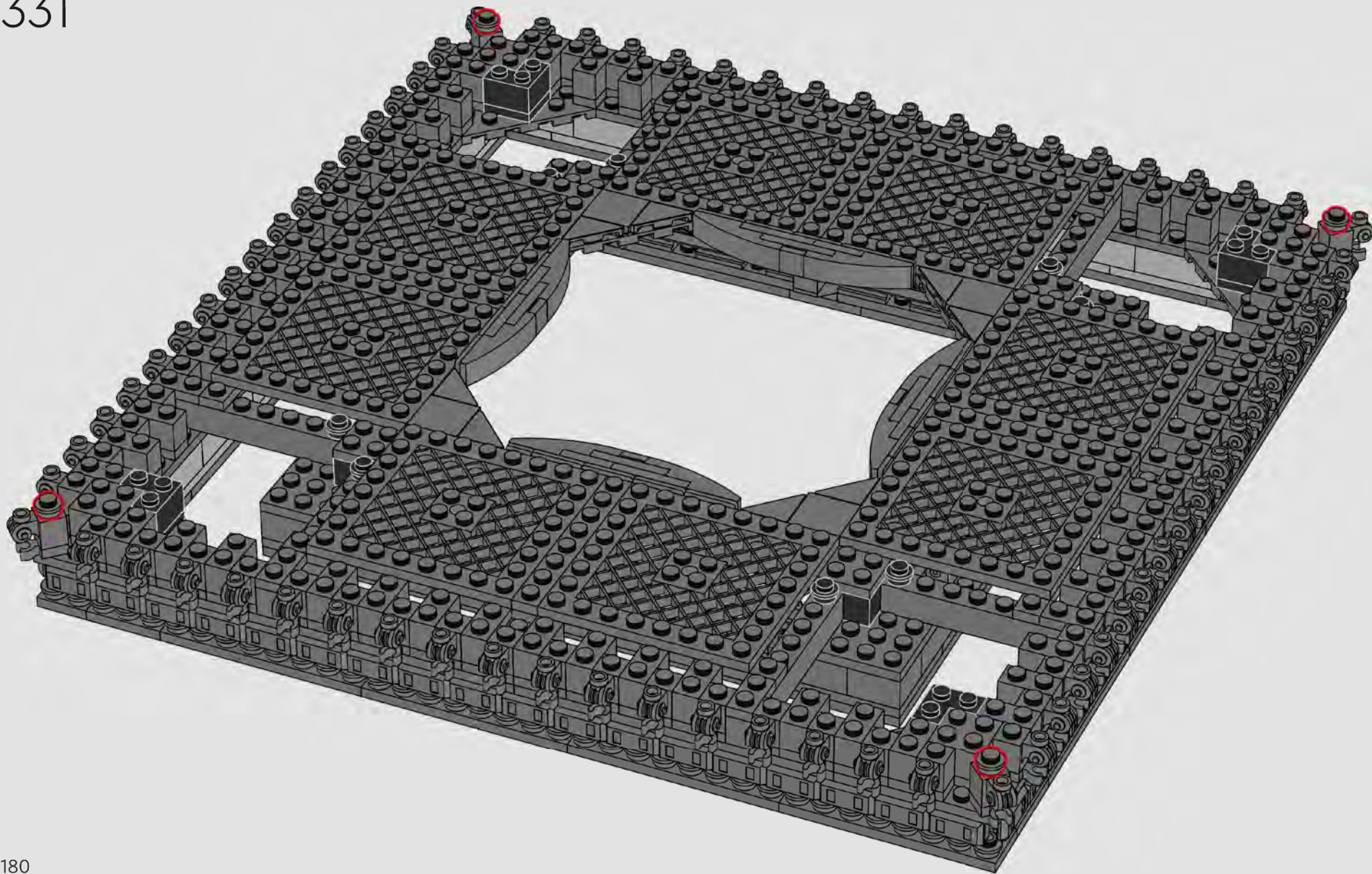



332

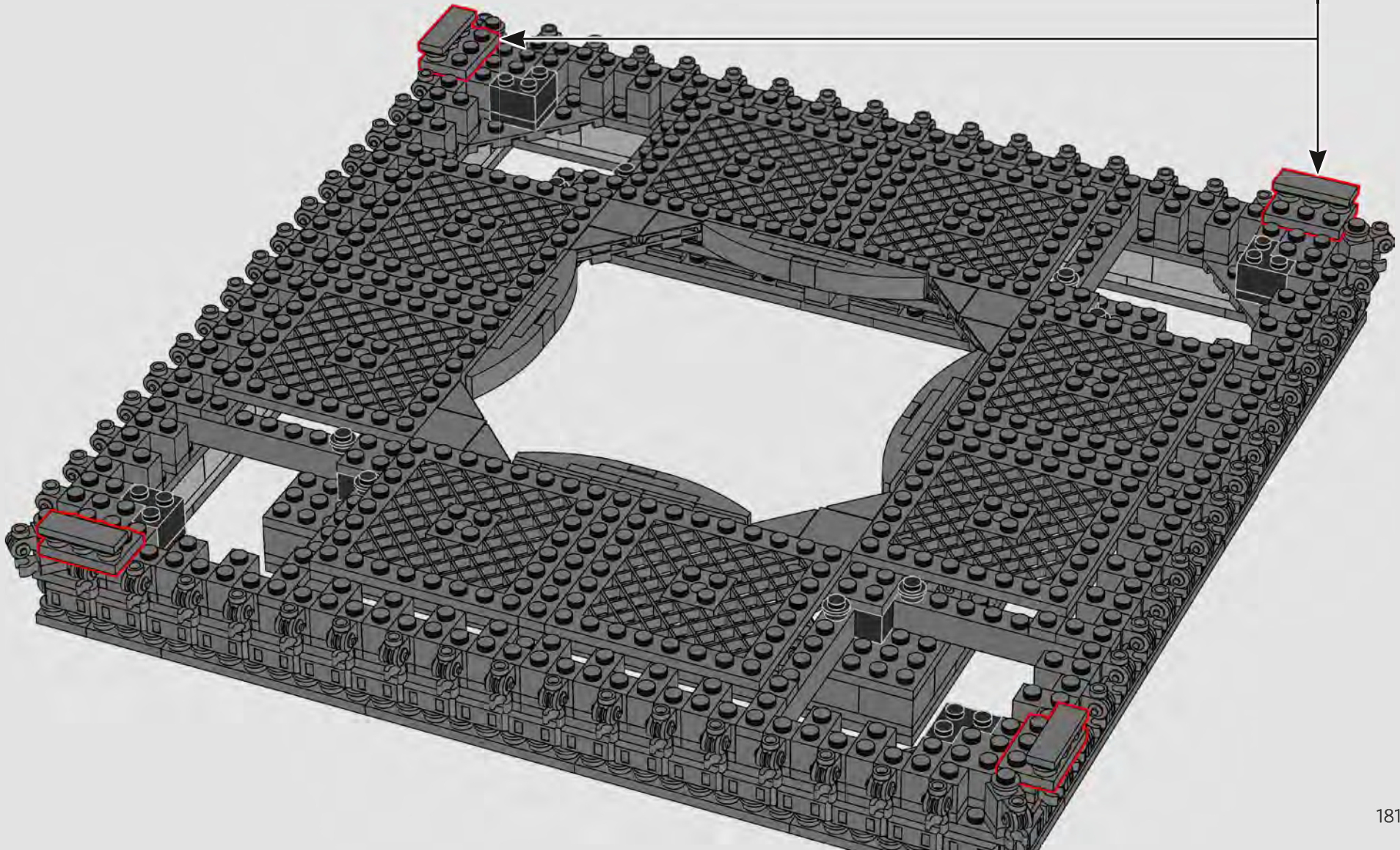
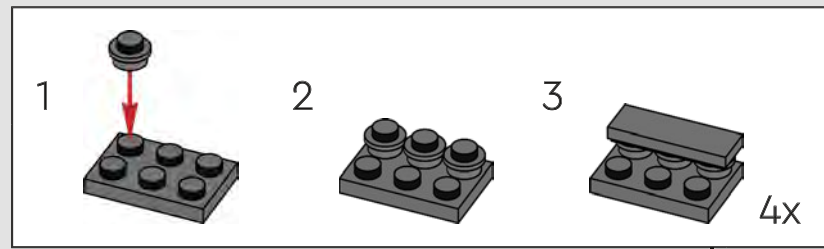

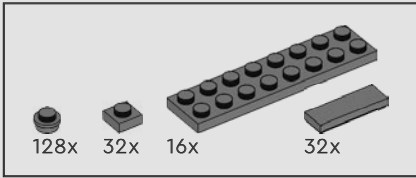
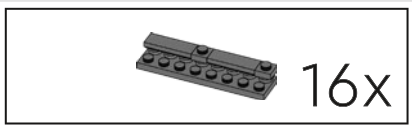

333

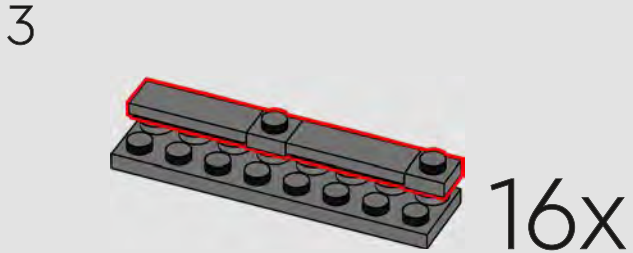
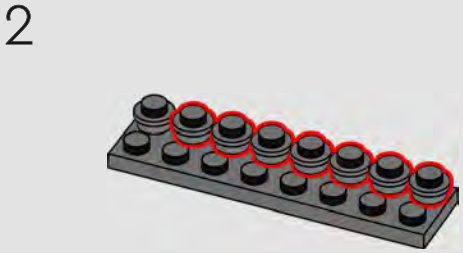

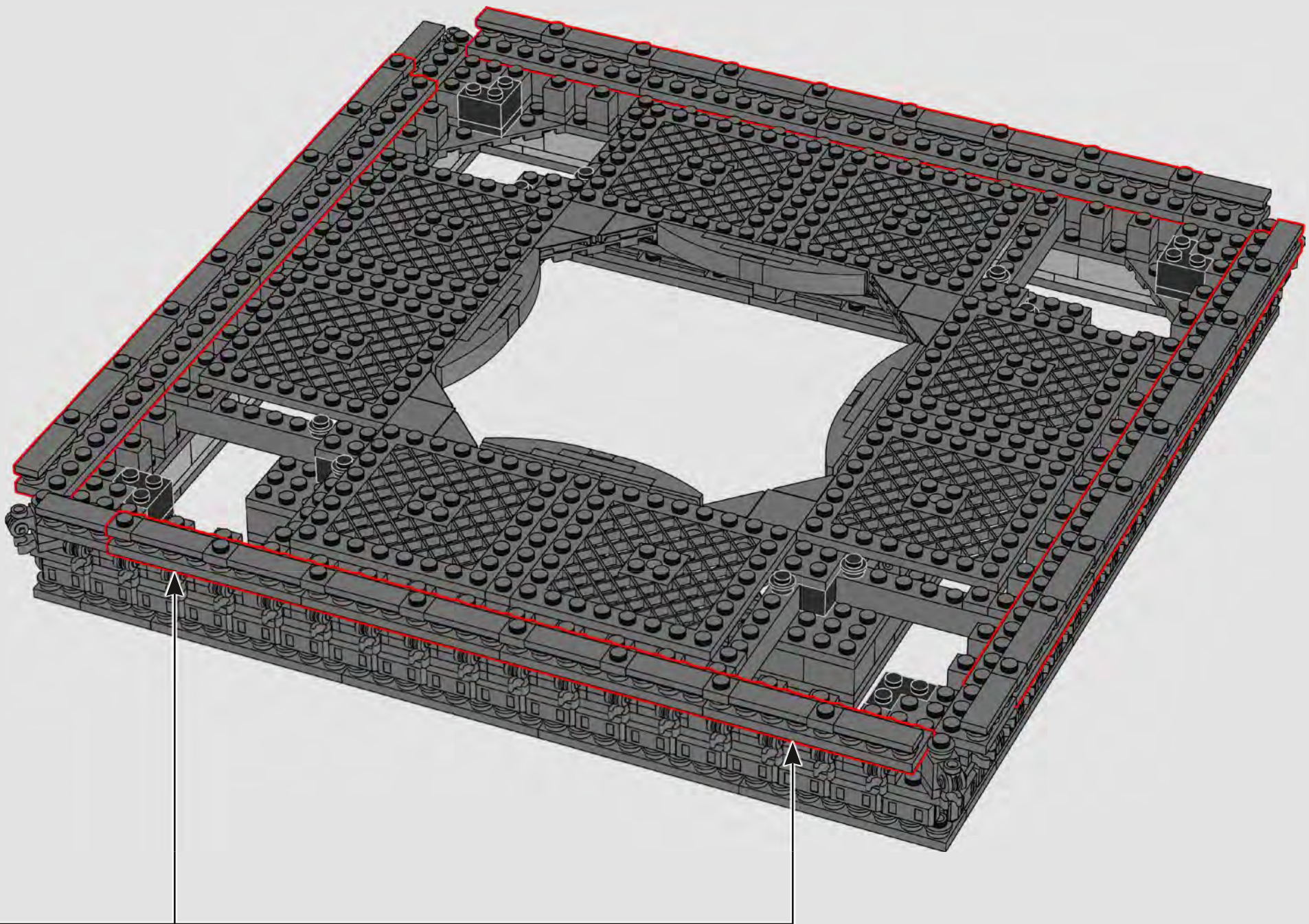

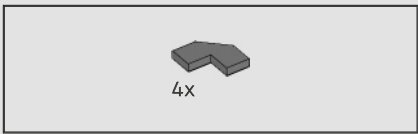

334

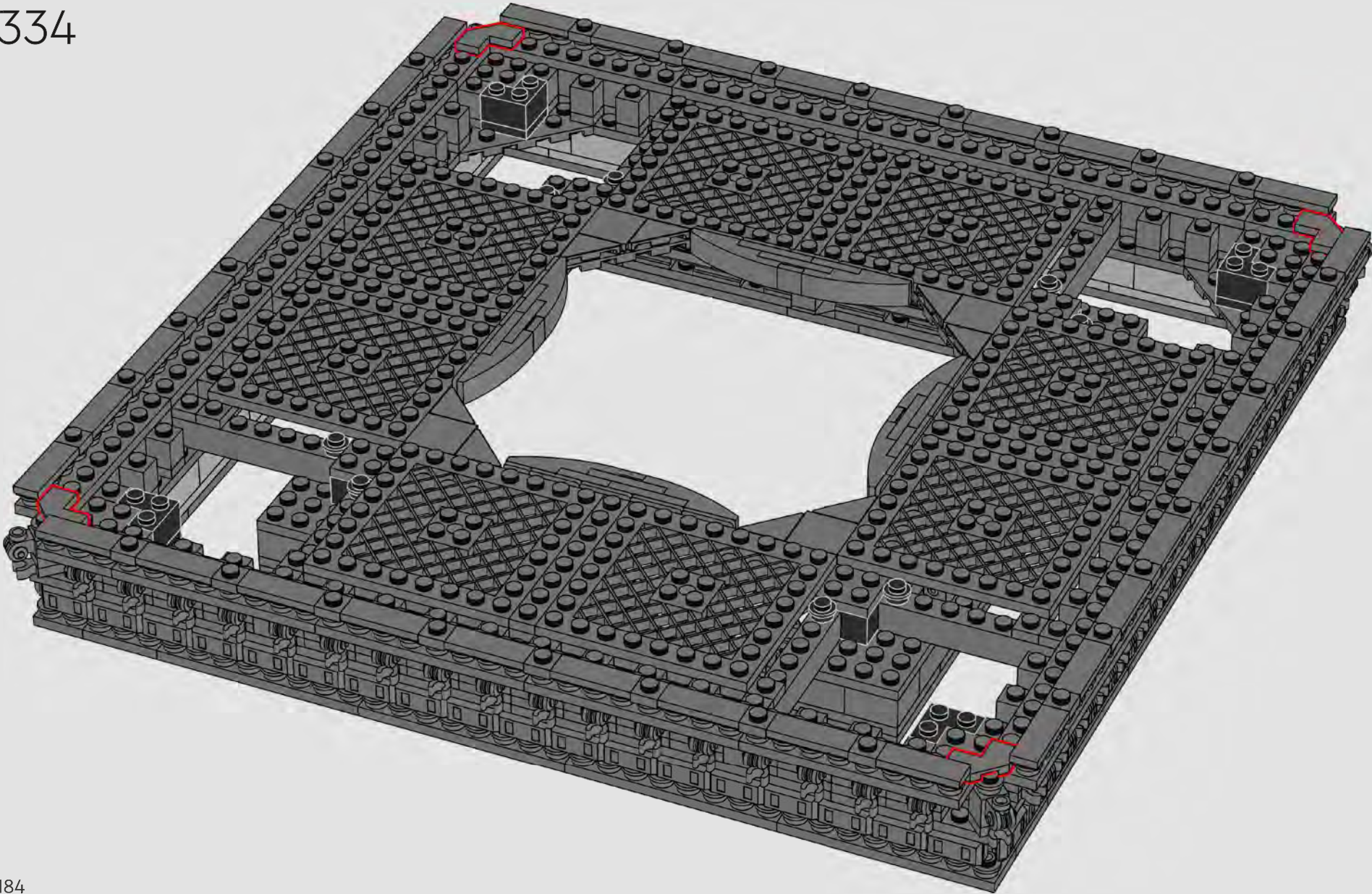

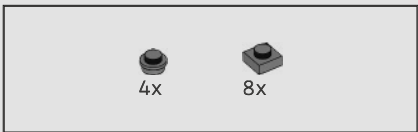

335

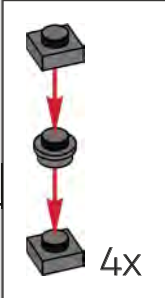
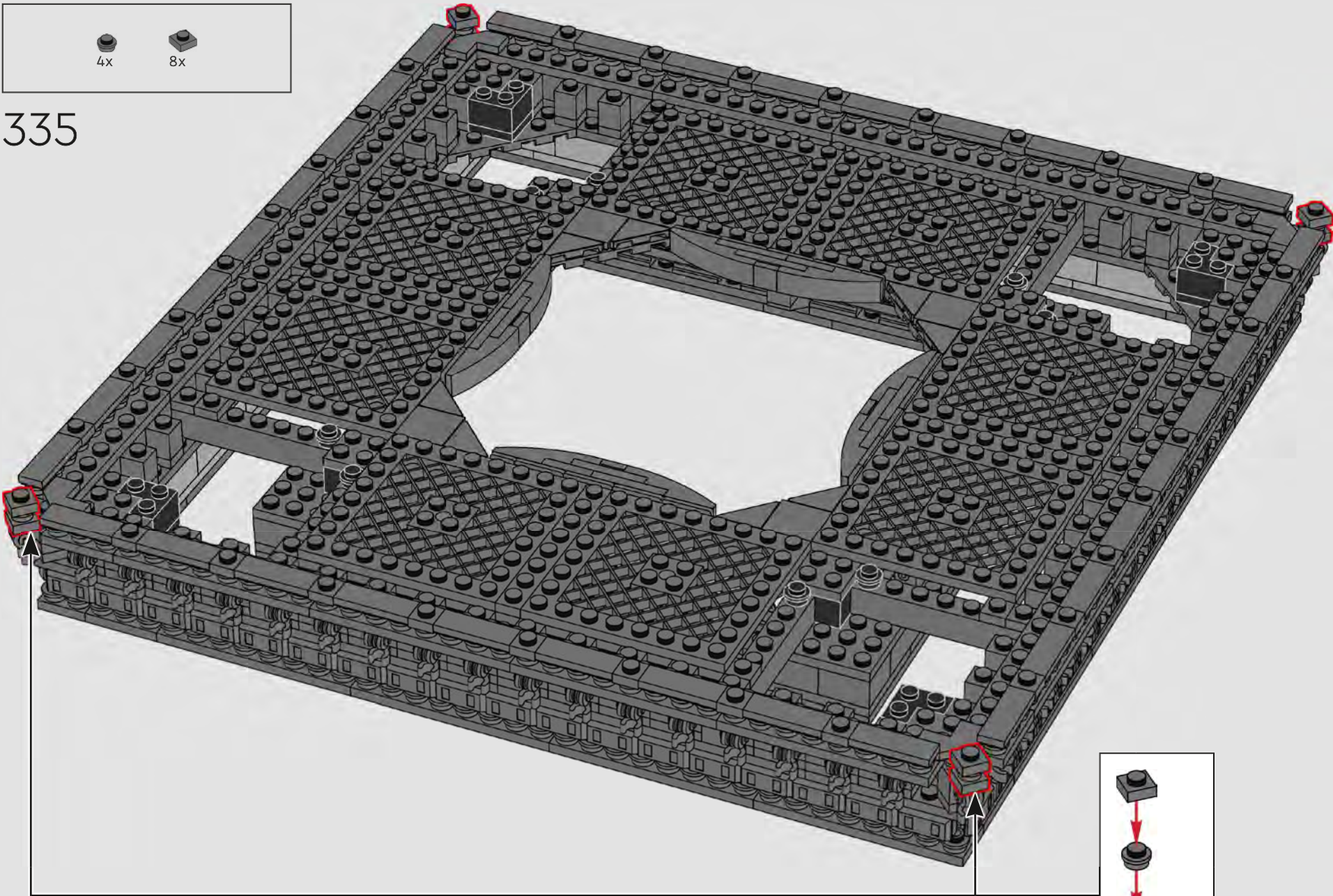



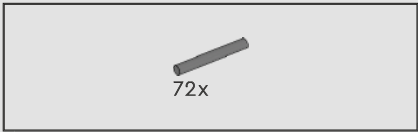

336

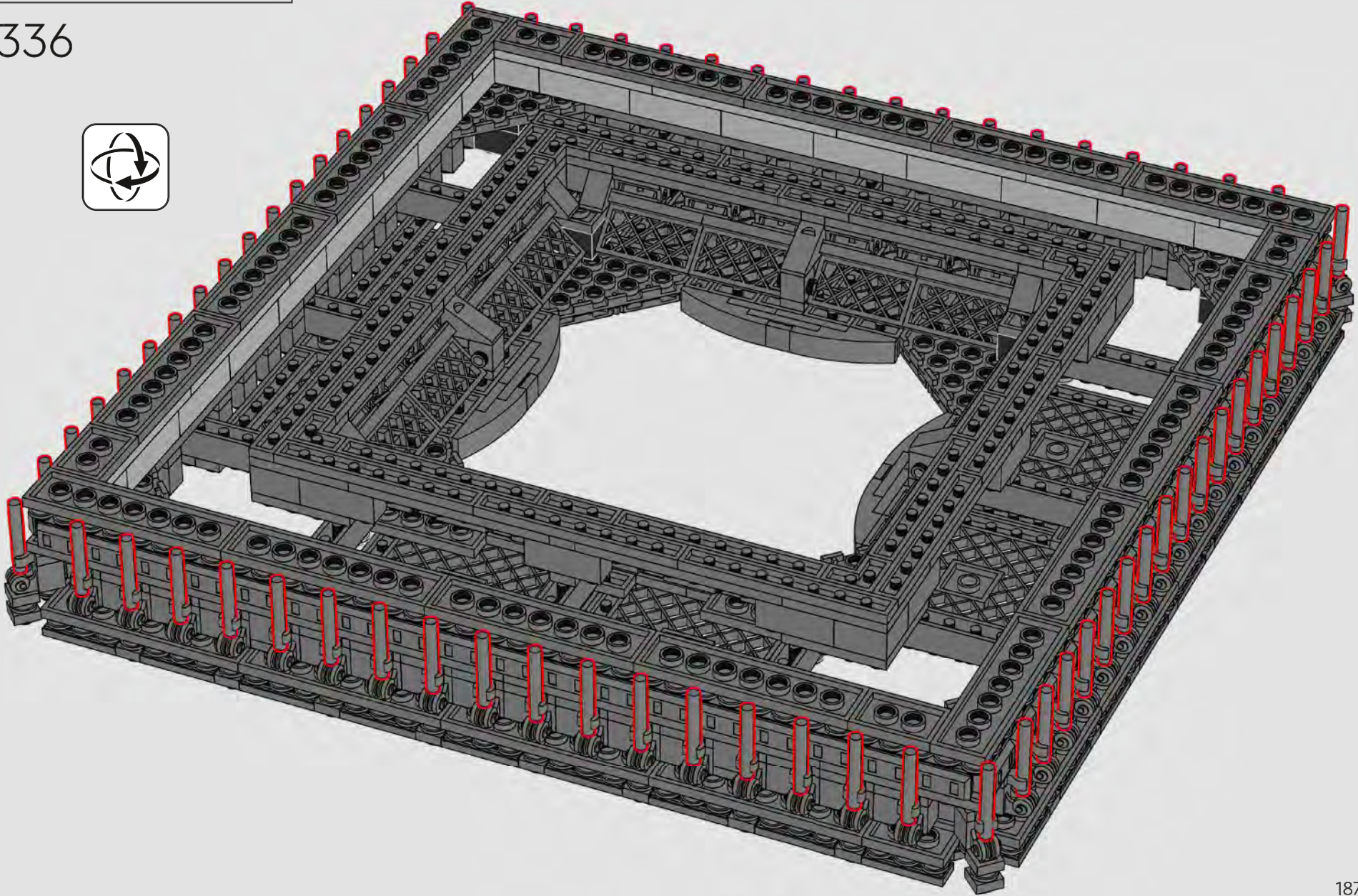

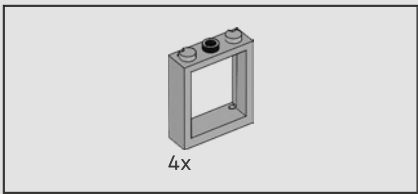

337

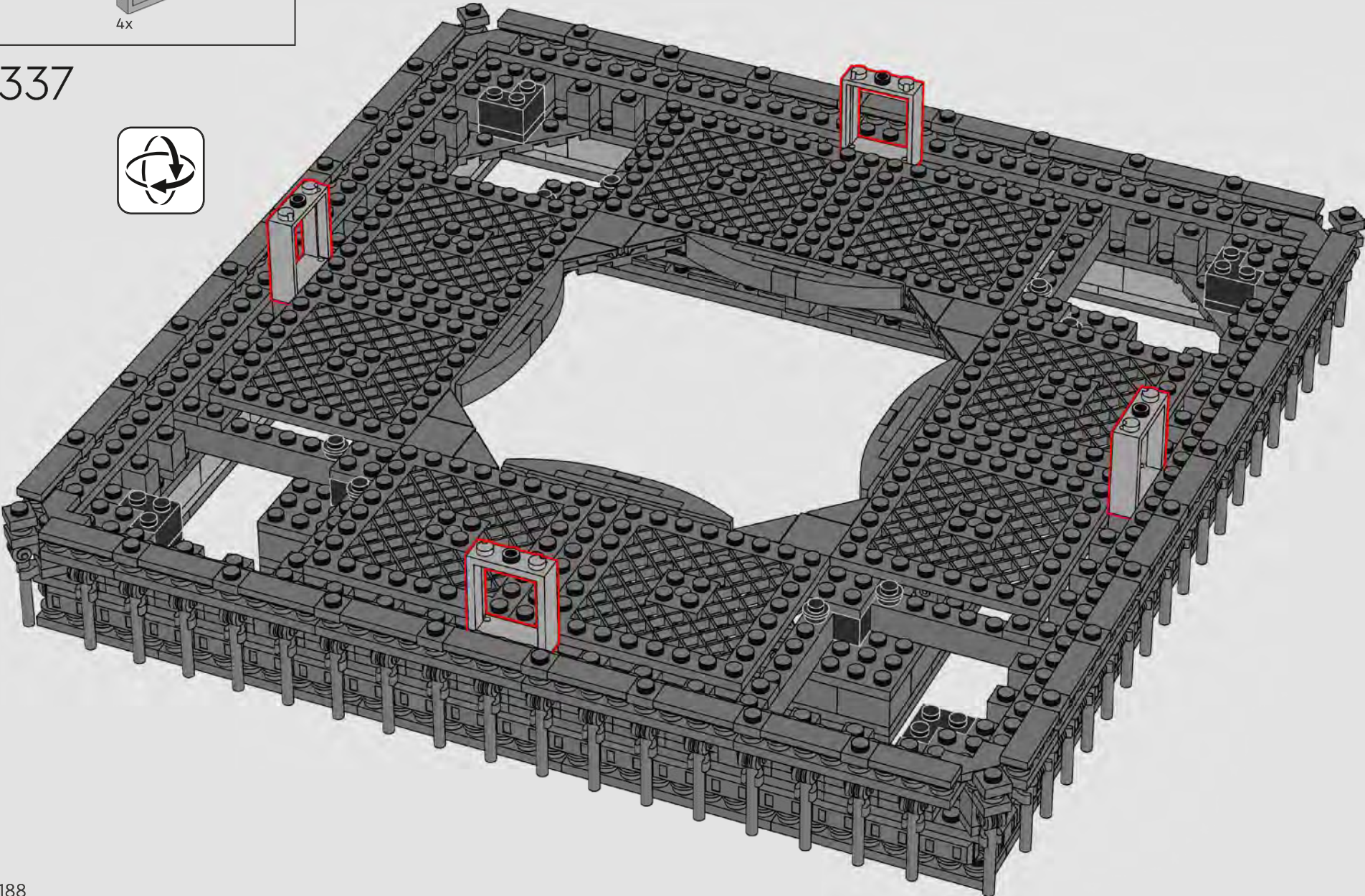

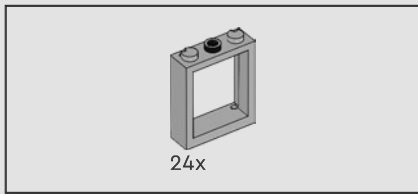

338

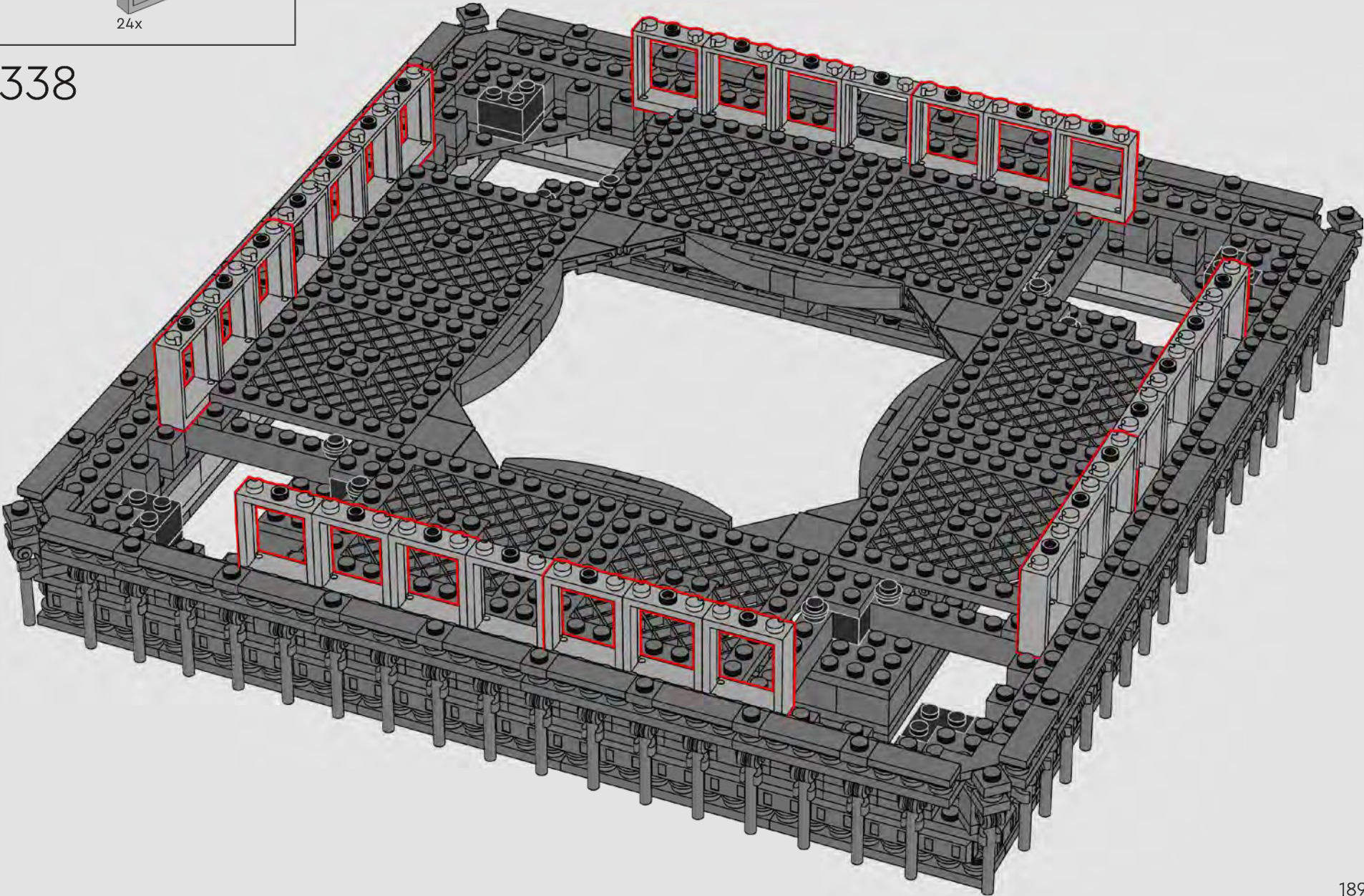

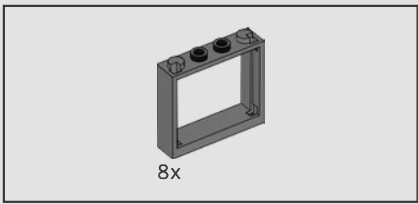

339

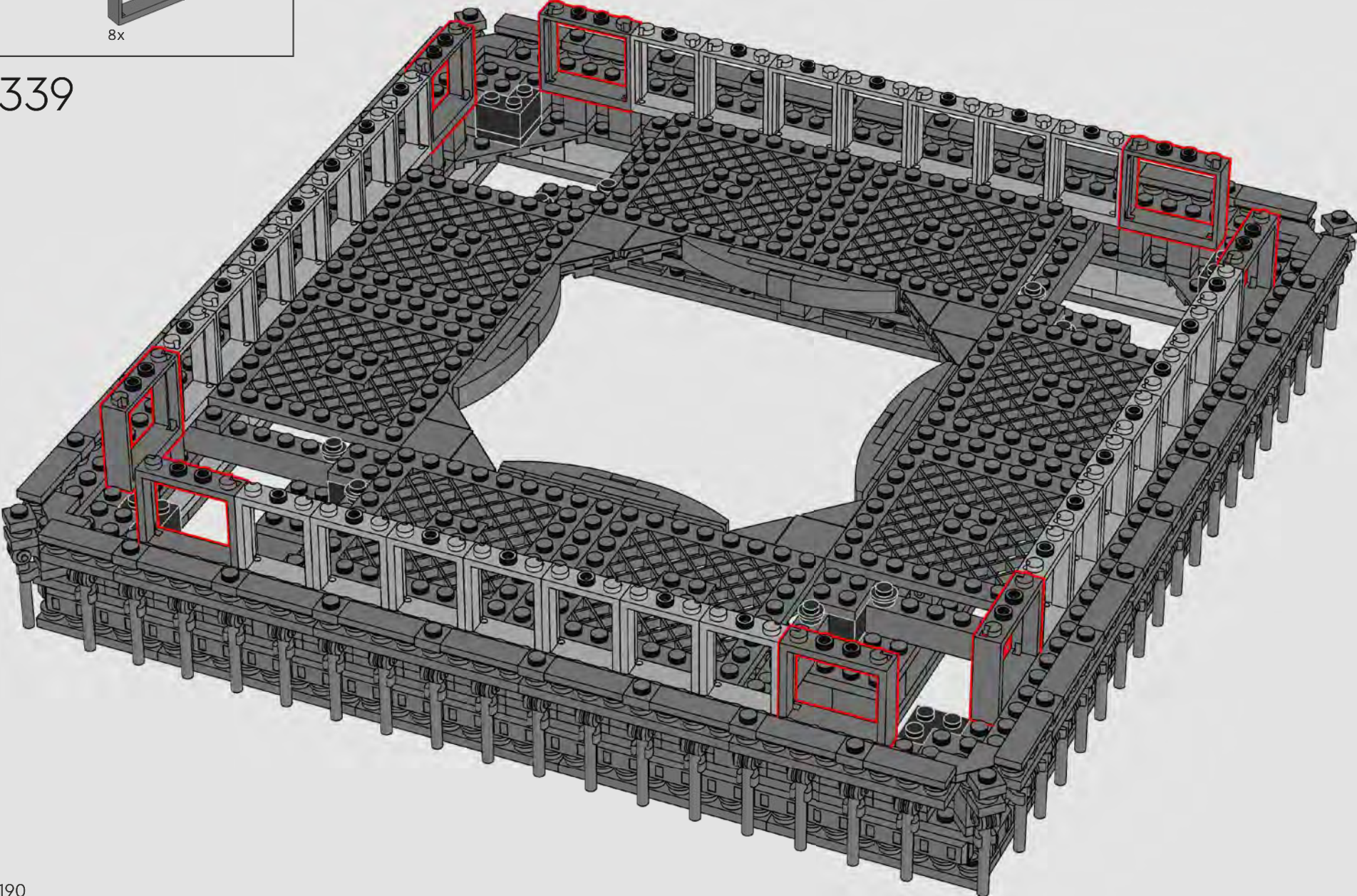

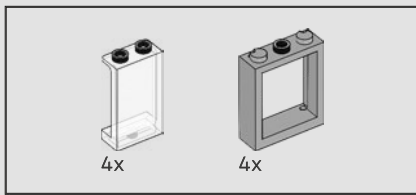

340

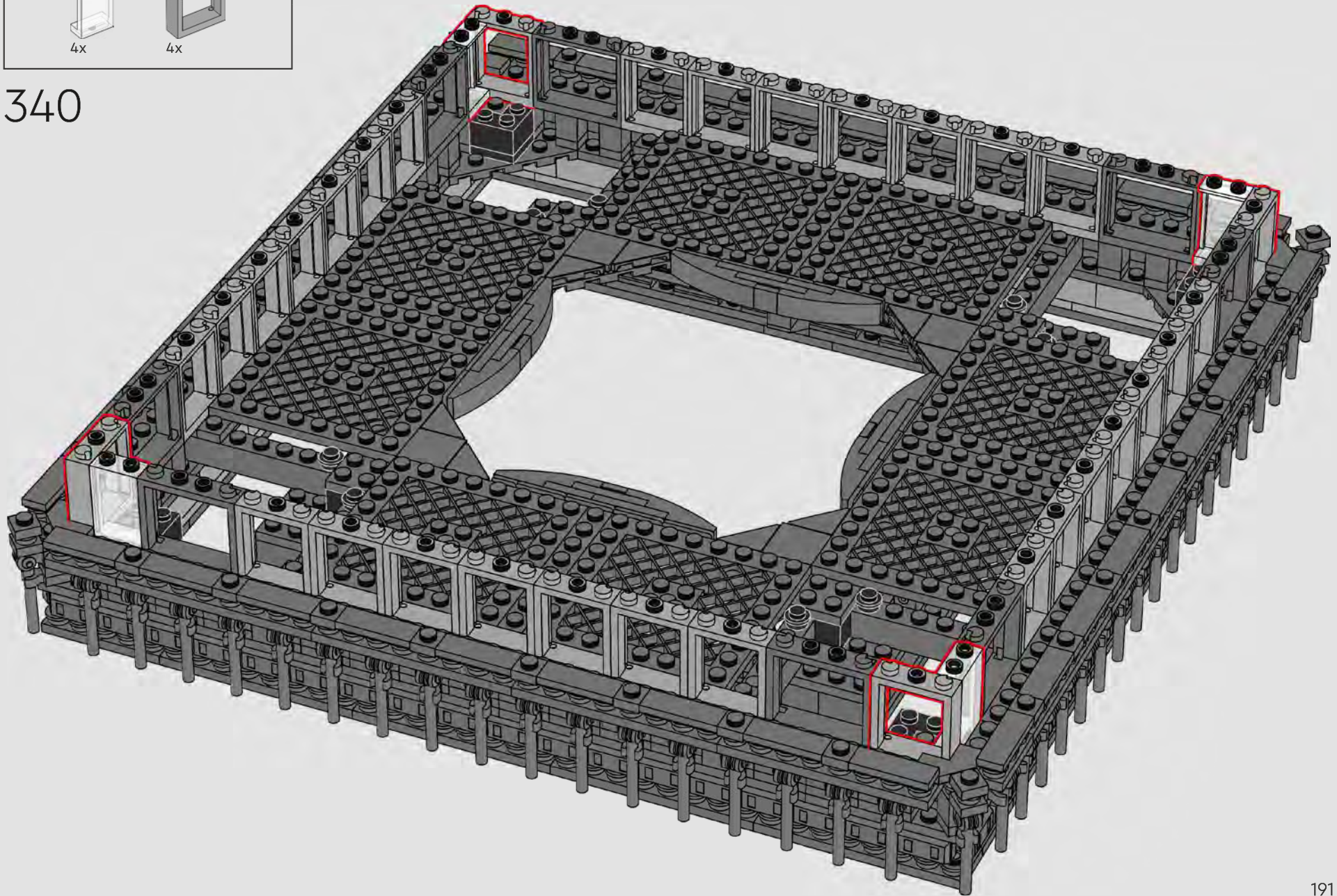

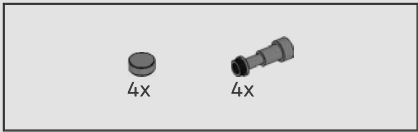

341

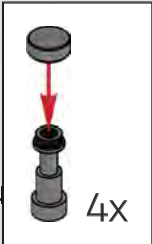
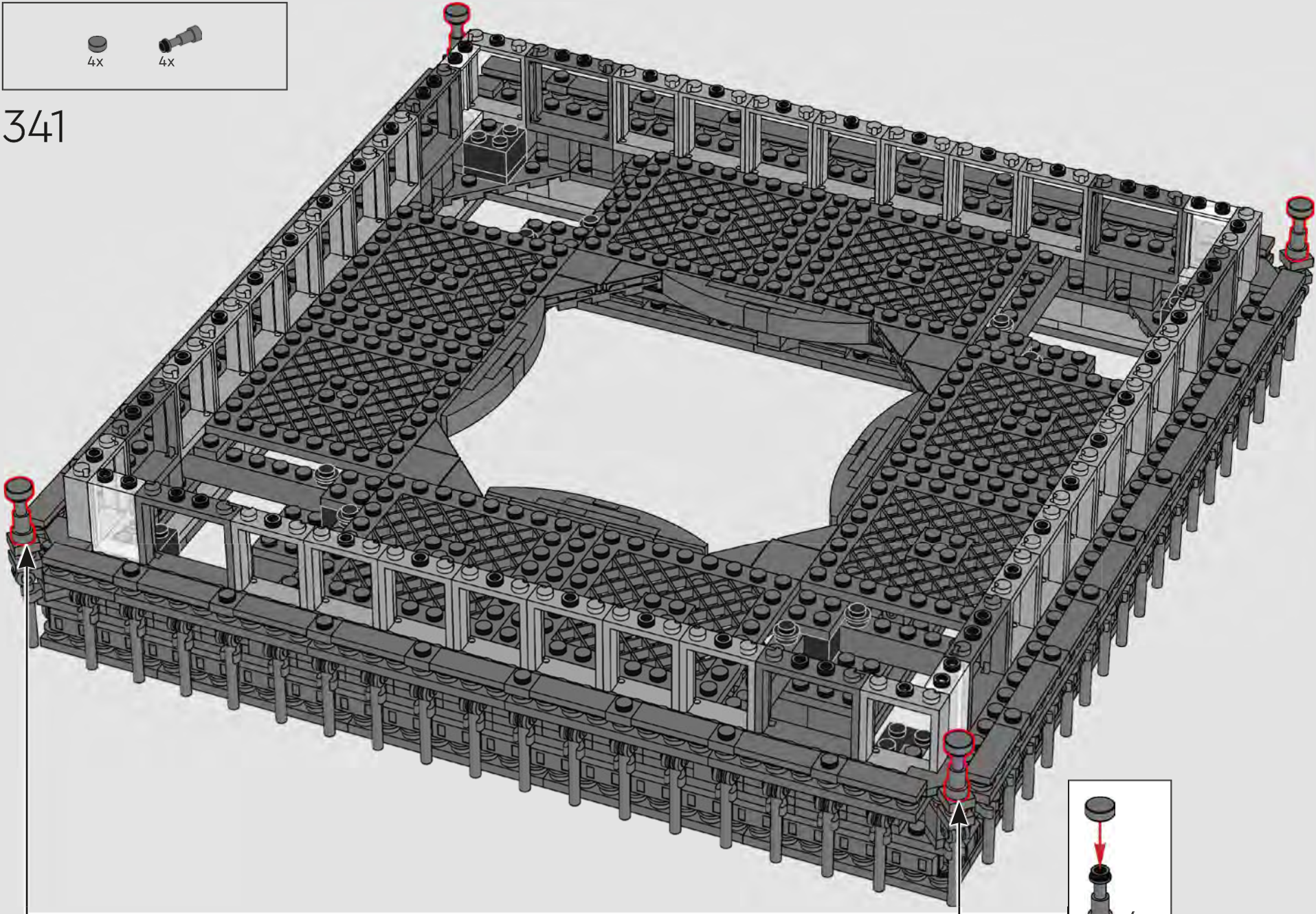



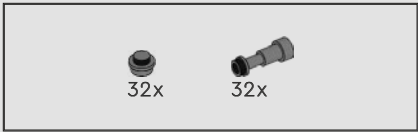

342

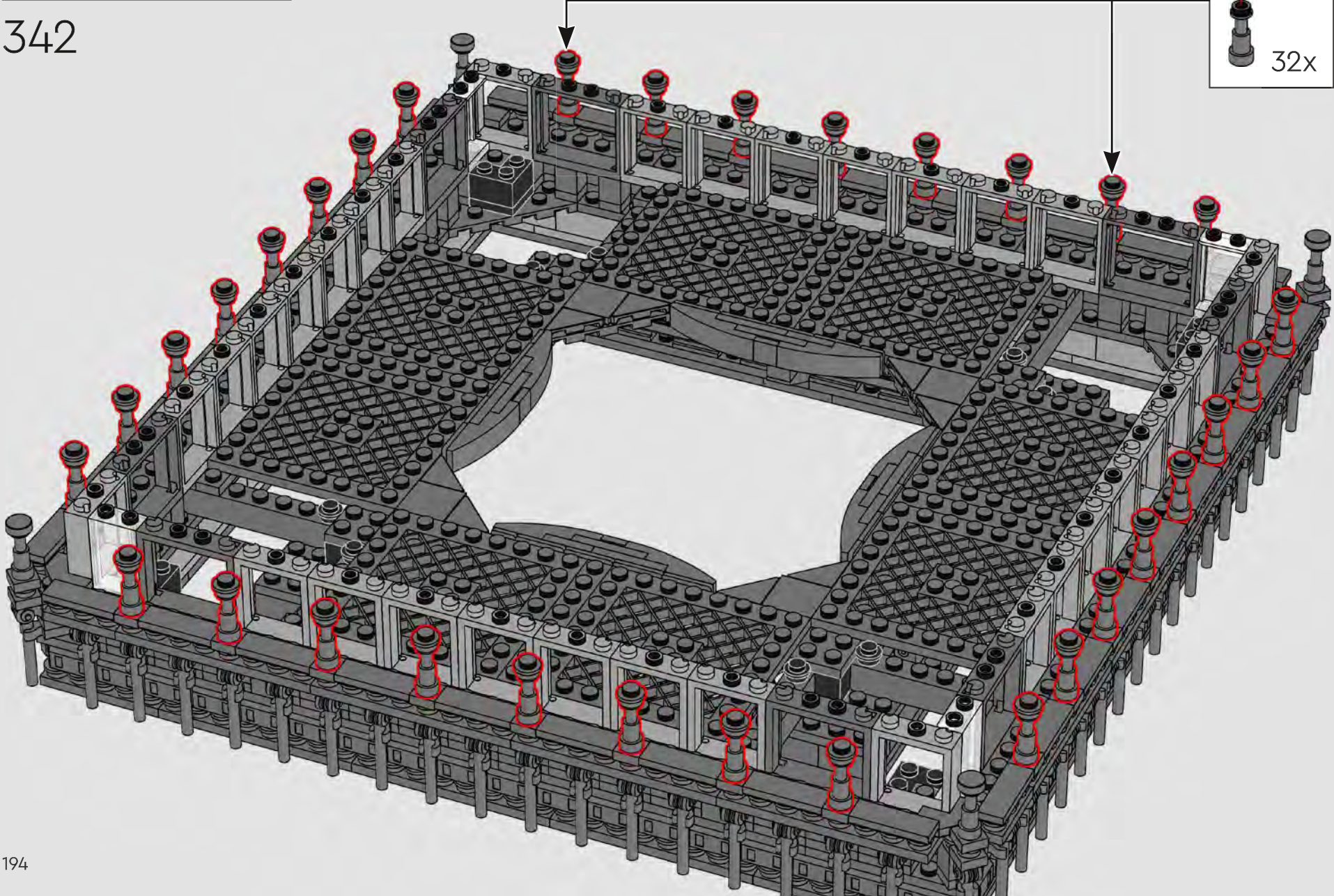
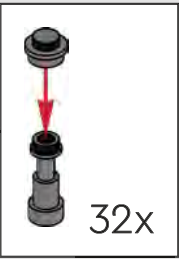

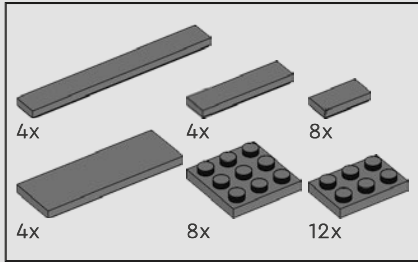
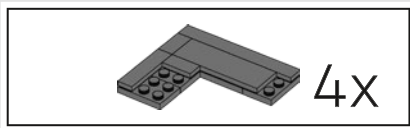

343

1

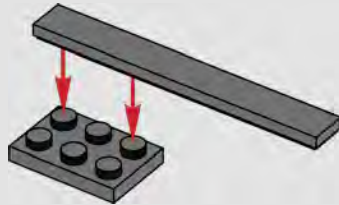

2

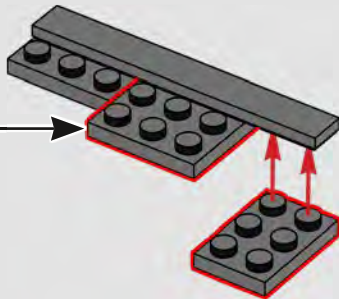
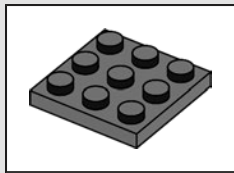

3

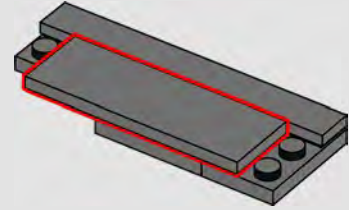

4

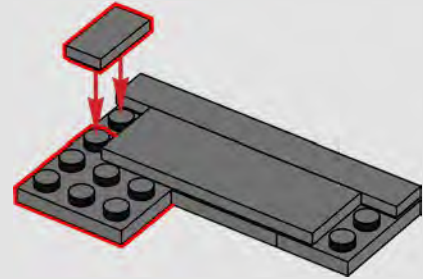

5

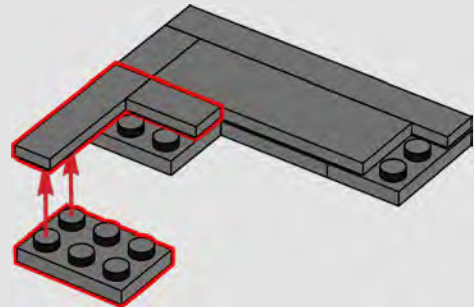

4x

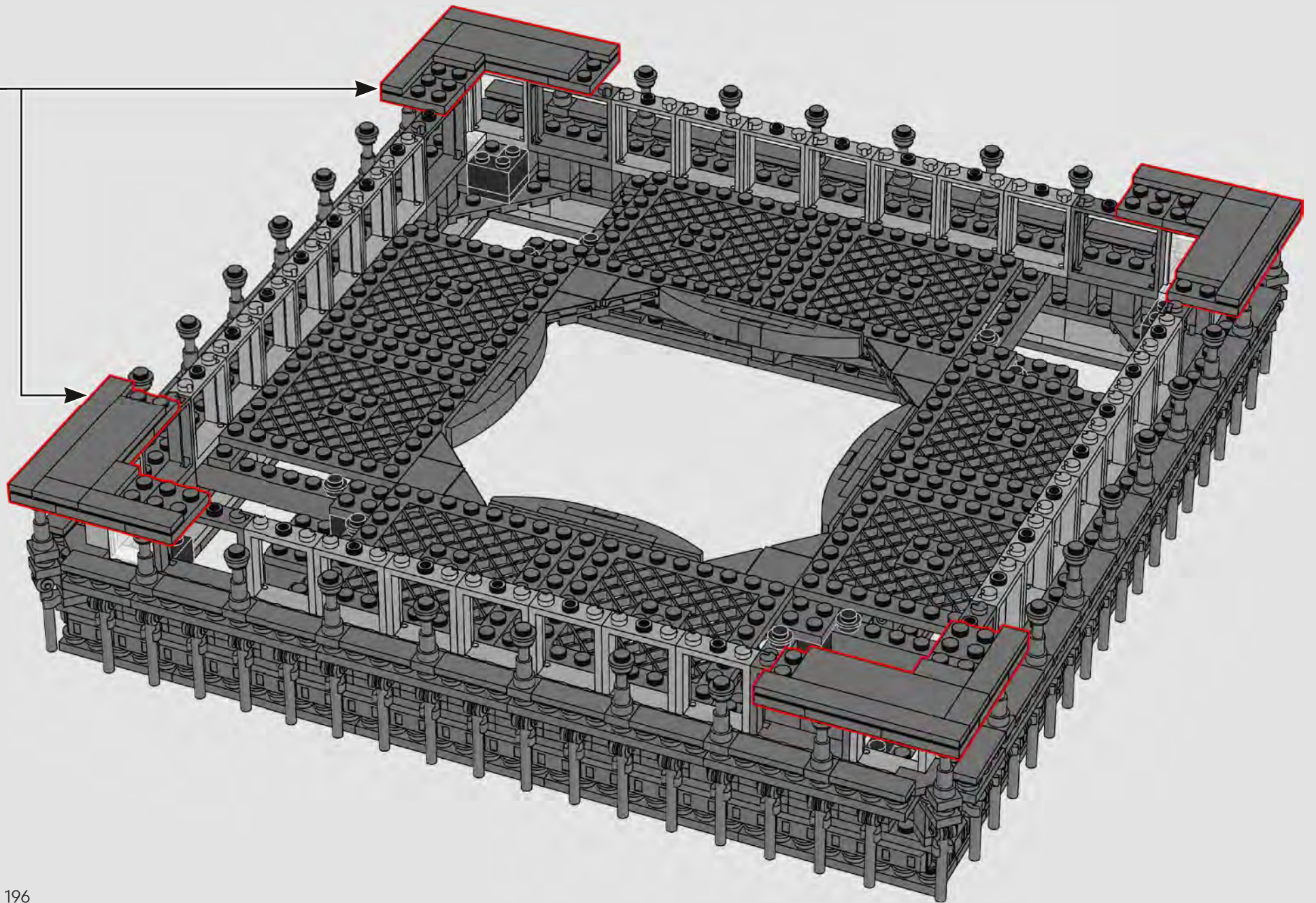

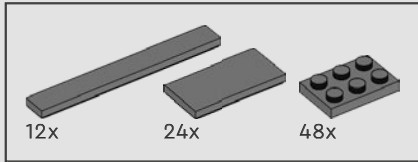
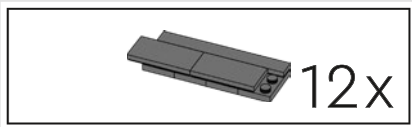

344

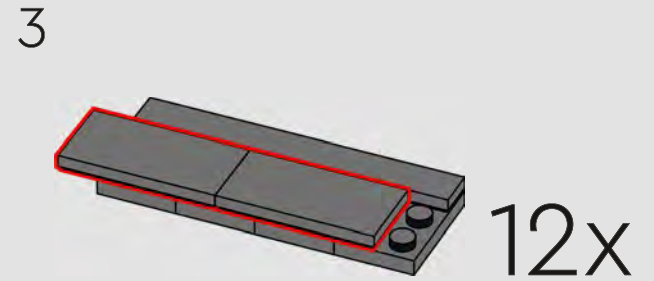
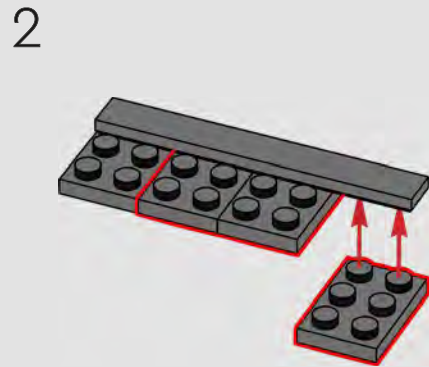
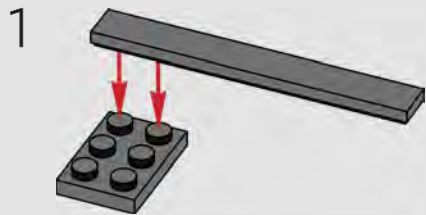

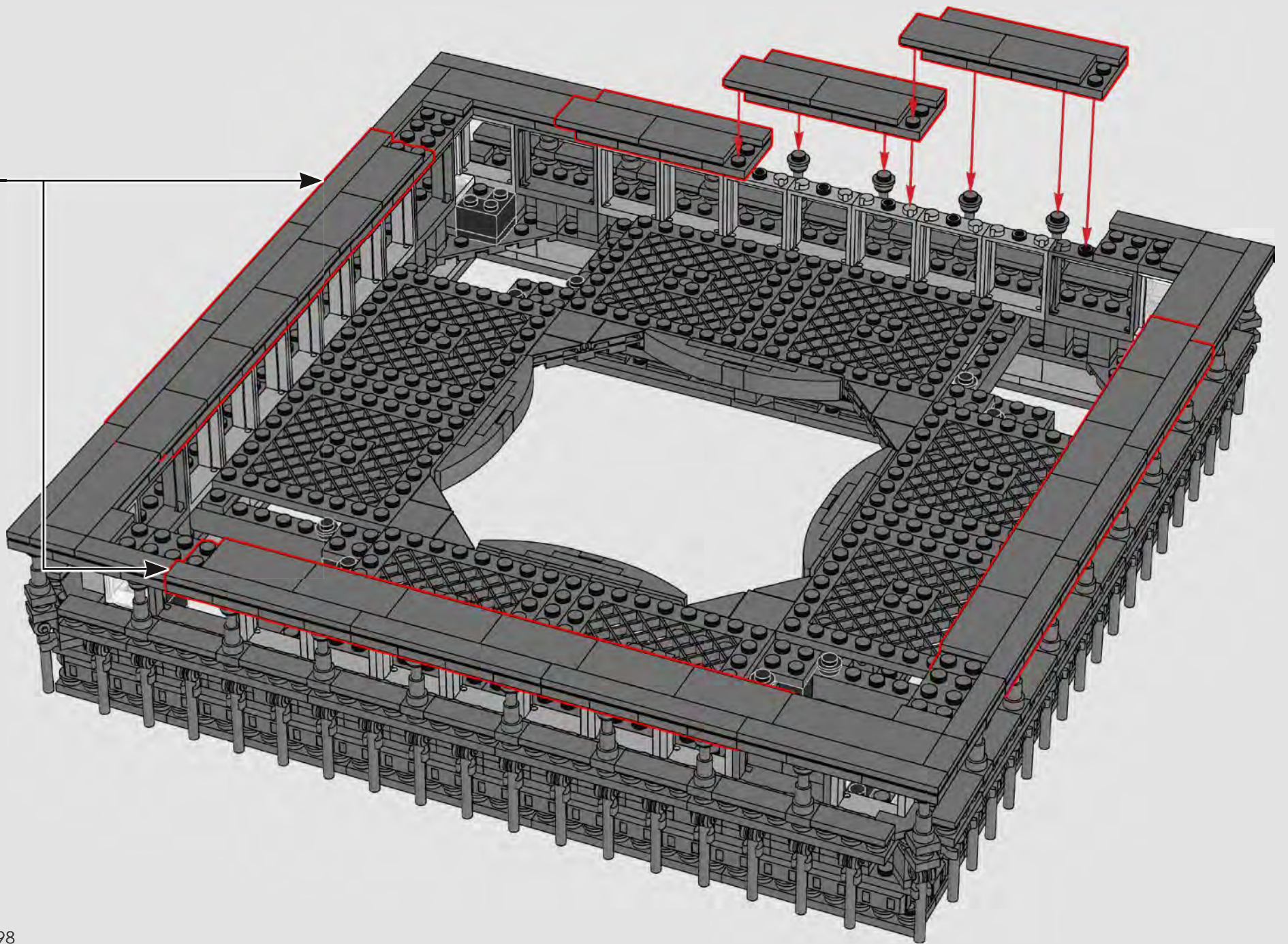

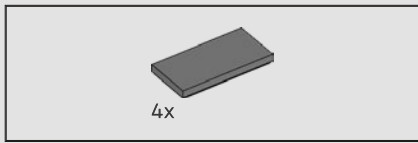

345

