

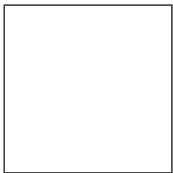

Booklet available in English on
Heft in deutscher Sprache erhältlich auf
Livret disponible en français sur
Libretto disponibile in italiano su
Folleto en español disponible en
如需中文版手册, 请访问





LEGO.com/sustainable-packaging



FR
DONNEZ
OU
RECYCLEZ



OU



OU



ASSOCIATION MAGASIN DÉCHÈTERIE

Adresses sur quefairedemesdechets.fr

LEGO® VIP

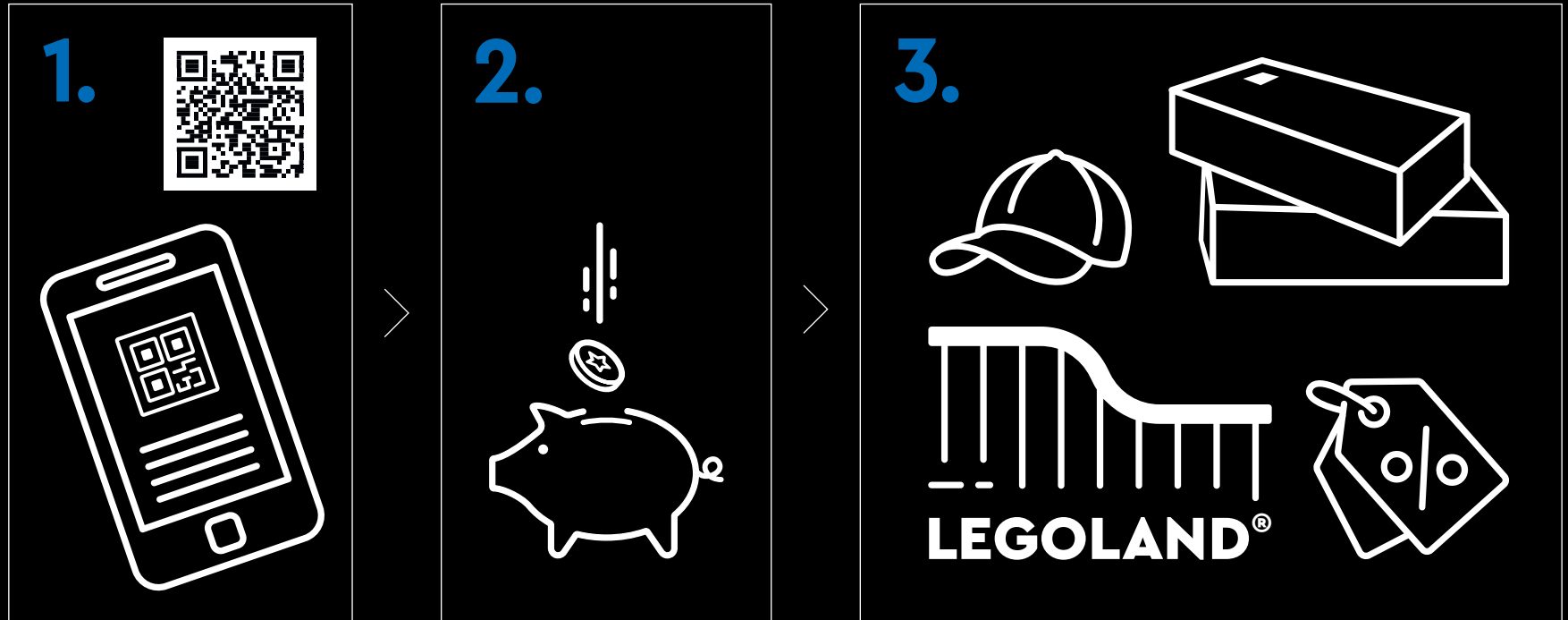

1. Sign up **2.** Earn points for purchases **3.** Redeem points for rewards, experiences, discounts & more | **1.** Melde dich an **2.** Sammle Punkte bei jedem Kauf **3.** Löse die Punkte für Belohnungen, Erlebnisse, Rabatte und Ähnliches ein | **1.** Inscrivez-vous **2.** Gagnez des points lors de vos achats **3.** Échangez vos points contre des récompenses, des expériences, des remises et bien plus encore | **1.** Iscriviti **2.** Guadagna punti con i tuoi acquisti **3.** Riscatta punti per premi, esperienze, sconti e altro ancora | **1.** Regístrate **2.** Gana puntos por tus compras **3.** Canjea puntos por recompensas, experiencias, descuentos y mucho más | **1.** Registe-se **2.** Ganhe pontos em compras **3.** Troque os pontos para prémios, experiências, descontos e muito mais | **1.** 注册 **2.** 购物赚积分 **3.** 用积分兑换奖励、体验、折扣等 | **1.** Zarejestruj się **2.** Zdobywaj punkty za zakupy **3.** Wymieniaj punkty na rabaty, przygody i inne nagrody | **1.** Zaregistrujte se **2.** Sbírejte body za nákupy **3.** Vyměňujte body za odměny, zážitky, slevy a spoustu dalšího | **1.** Zaregistrujte se **2.** Získavajte body za nákupy **3.** Uplatnite si body a získajte odmeny, rôzne zážitky, zľavy a ešte viac | **1.** Regisztrálj **2.** Szerezz pontokat minden vásárlással **3.** Váltsd be pontjaidat jutalmakra, élményekre, kedvezményekre és egyebekre | **1.** Înscric-te **2.** Câștigă puncte pentru achiziții **3.** Valorifică puncte pentru recompense, experiențe, reduceri și multe altele | **1.** Регистрируйте се **2.** Получайте точки за покупки **3.** Используйте точки за награды, услуги, отстъпки и т.н. | **1.** Reģistrējies **2.** Pelni punktus par pirkumiem **3.** Izmanto punktus, lai saņemtu balvas, izklaides iespējas, atlaides un daudz ko citu | **1.** Registreeru **2.** Teeni ostude eest punkte **3.** Lunasta punktide eest preemiad, elamused, allahindlused ja muu | **1.** Užsiregistruokite **2.** Pelnykite taškus už pirkinius **3.** Panaudokite taškus atlygiui, funkcijoms, nuolaidoms ir ne tik





BOOK YOUR FREE TICKETS HERE

'Prepare your VIP ribbon-cutting ceremony, the LEGO® Natural History Museum is officially ready to open! And it's big enough to house the entire skeleton of an enormous Brachiosaurus. (Or perhaps its lesser-known relative, the Brickiosaurus?) Join a cast of dedicated staff and enthusiastic museum visitors as you curate inspiring exhibits, discover new building techniques and journey through the Mesozoic era to the future of space travel. And, as any respectable museum would do, we have dug through our own LEGO history and uncovered precious and fun artifacts to exhibit throughout this modular set.'

CHRIS MCVEIGH

Designer of the 10326 Natural History Museum



EXPLORE THE COLLECTIONS

Enter the museum and you'll be greeted in the gift shop, which features interesting pamphlets about the collections and exhibits and, of course, assorted memorabilia and souvenirs. We start our tour on the ground floor, where we peruse the natural history exhibit, with important finds from delicate pottery and fossils to rocks and the magnificent Brachiosaurus. Travelling up to the first floor, we journey through our own past and peek into the future of space exploration. Please note that only museum staff have access to the rooftop area, but if you ask the curator nicely, he may extend your tour to his office. Enjoy your day and feel free to extend your stay!



Someone call security! A curious puppy is sneaking a bone through the back door! A vigilant museum employee is right on his heels and makes sure the bone is returned to the curator.



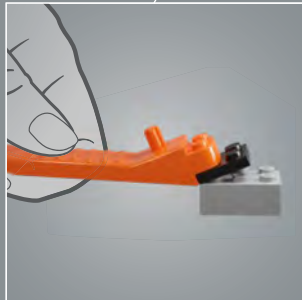
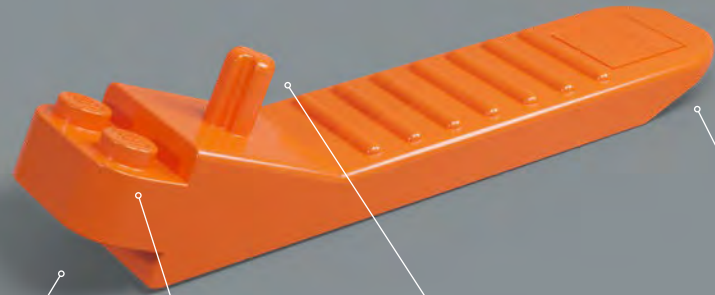

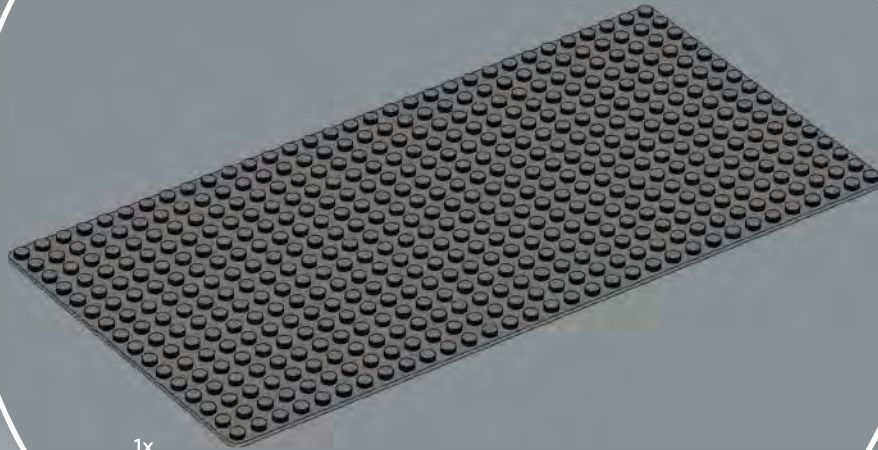
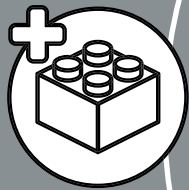

1x

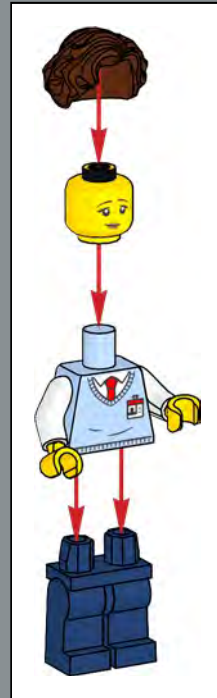

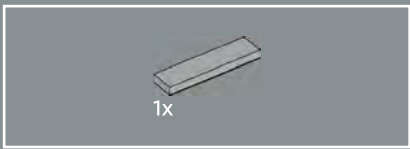

1

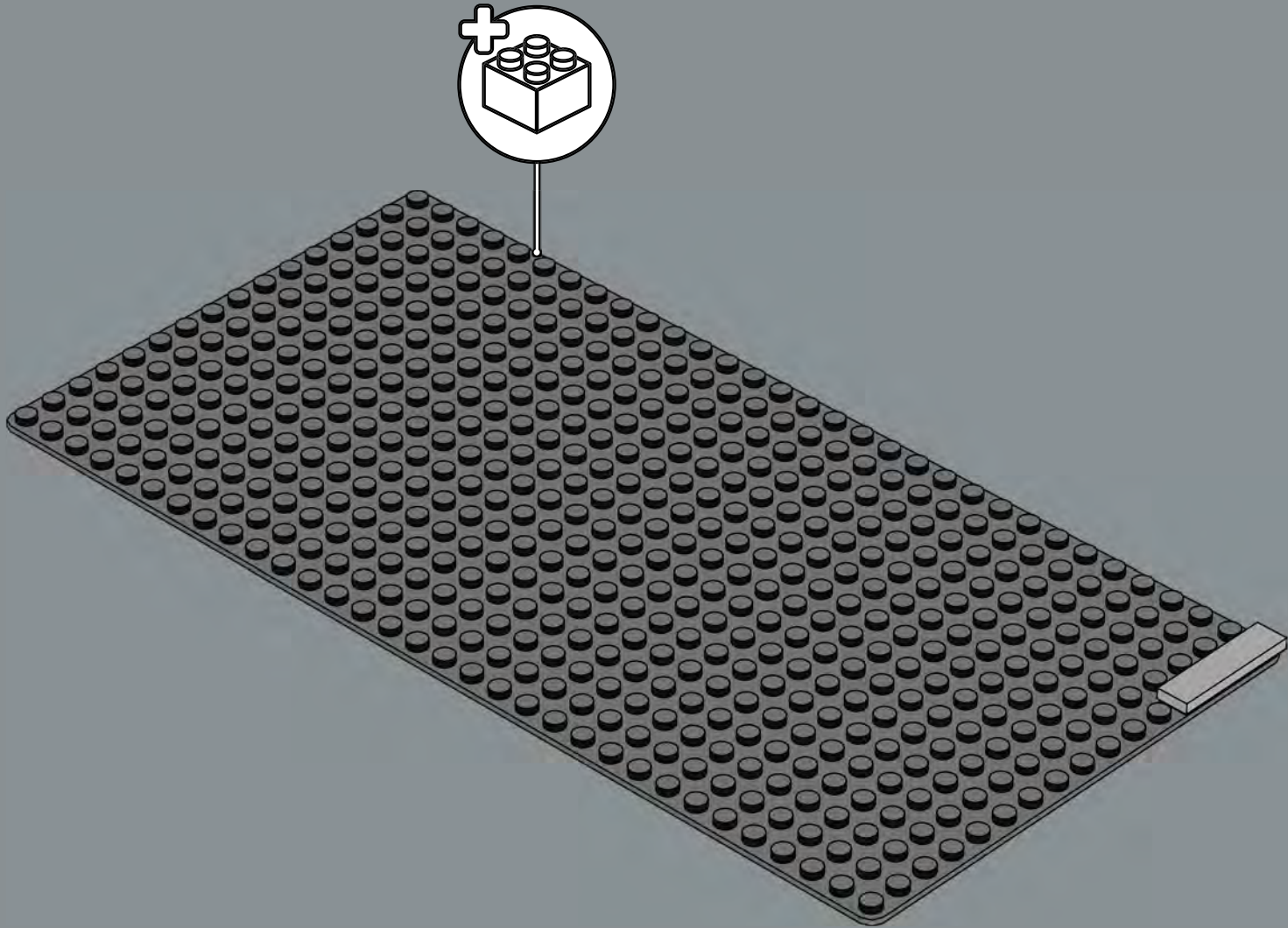

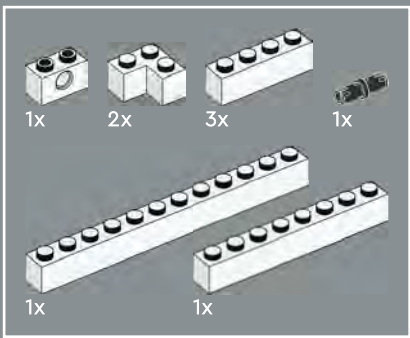

3

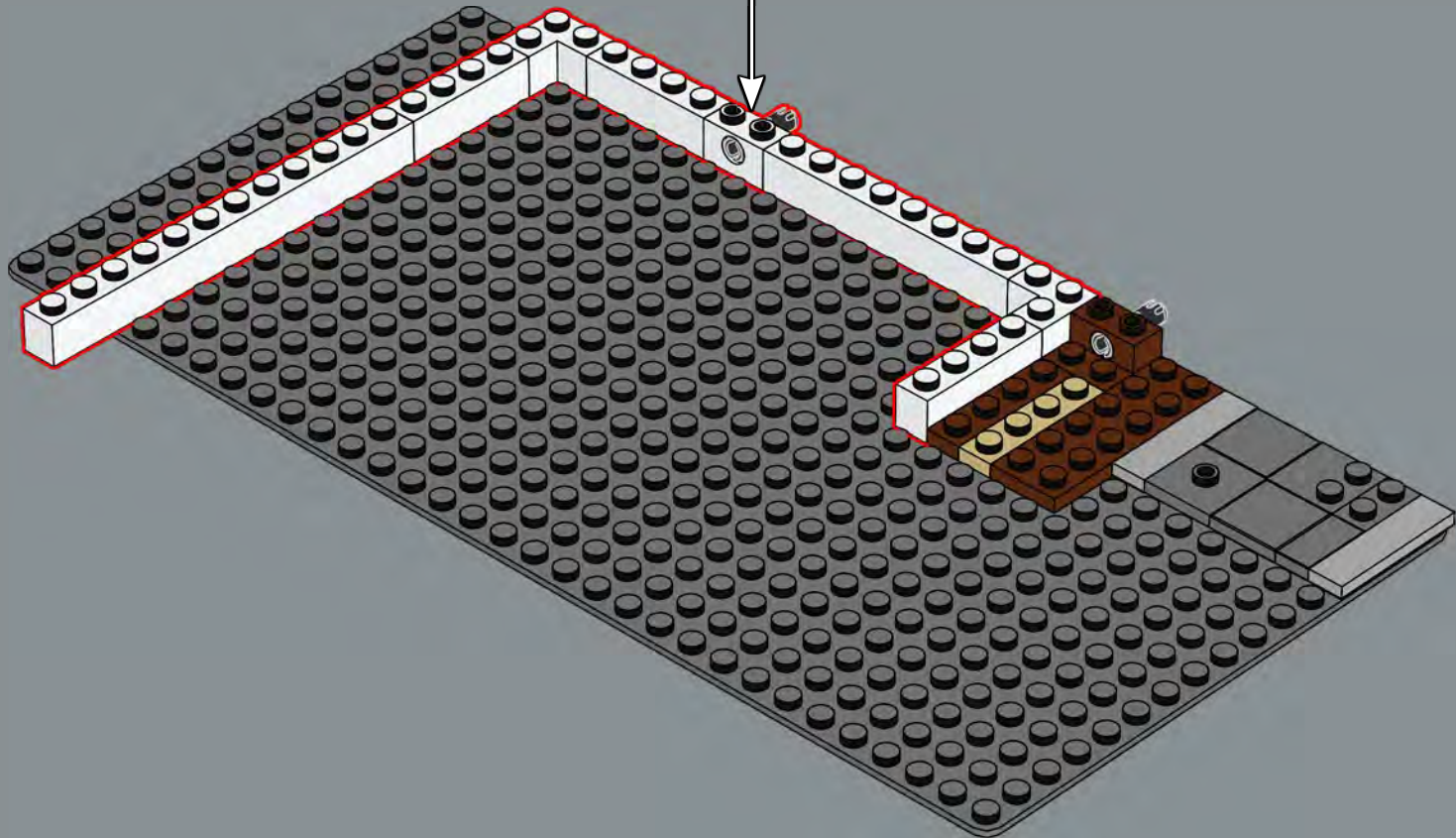
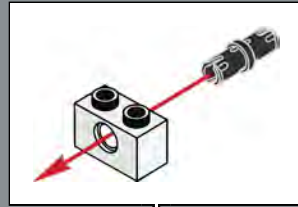

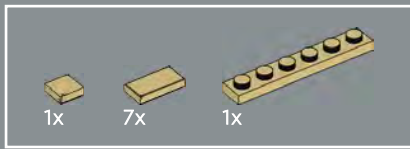

4

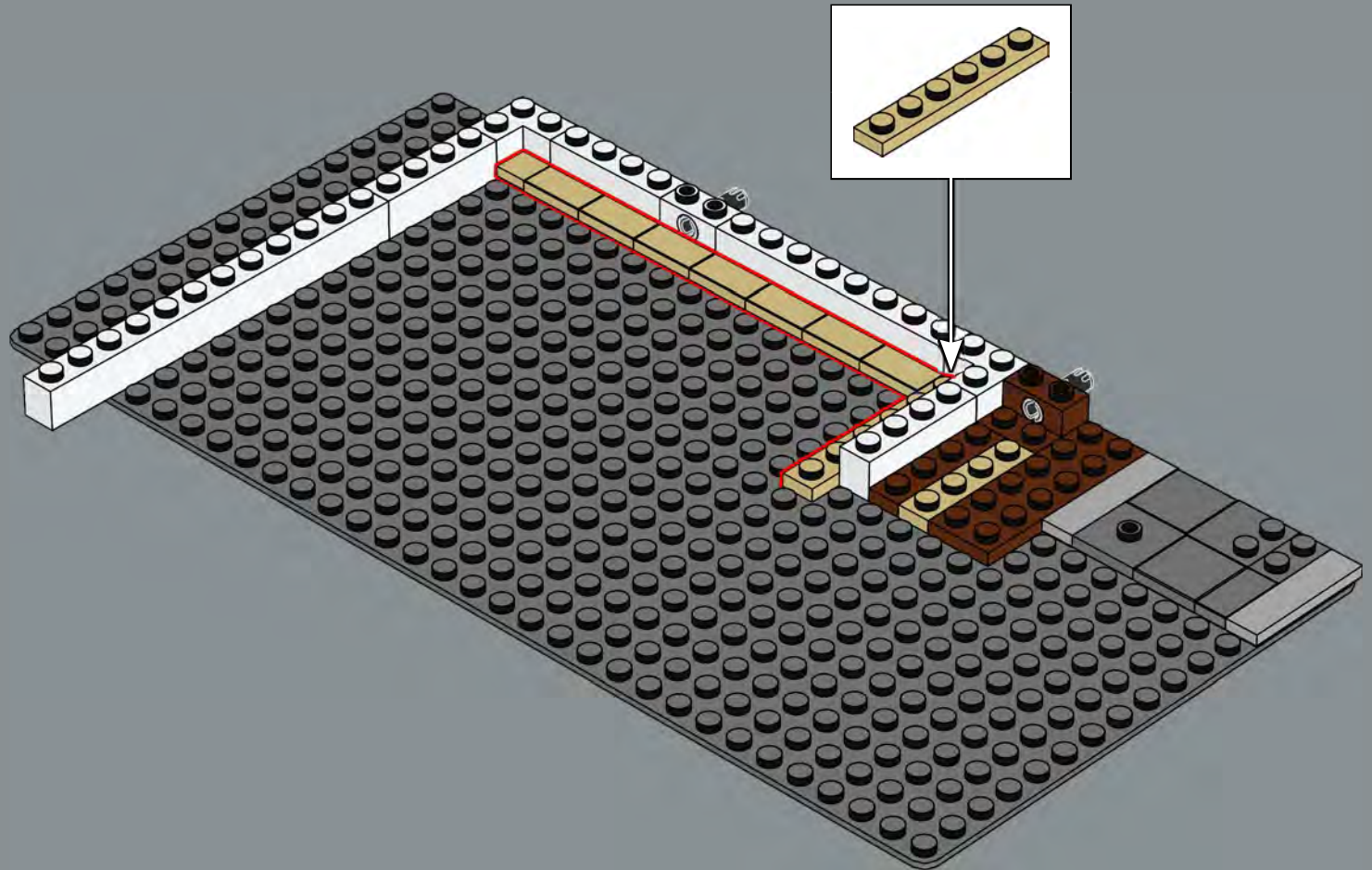

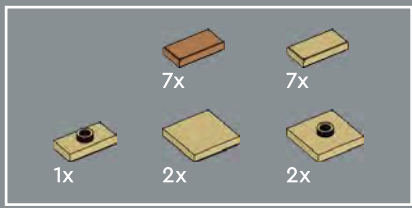

5

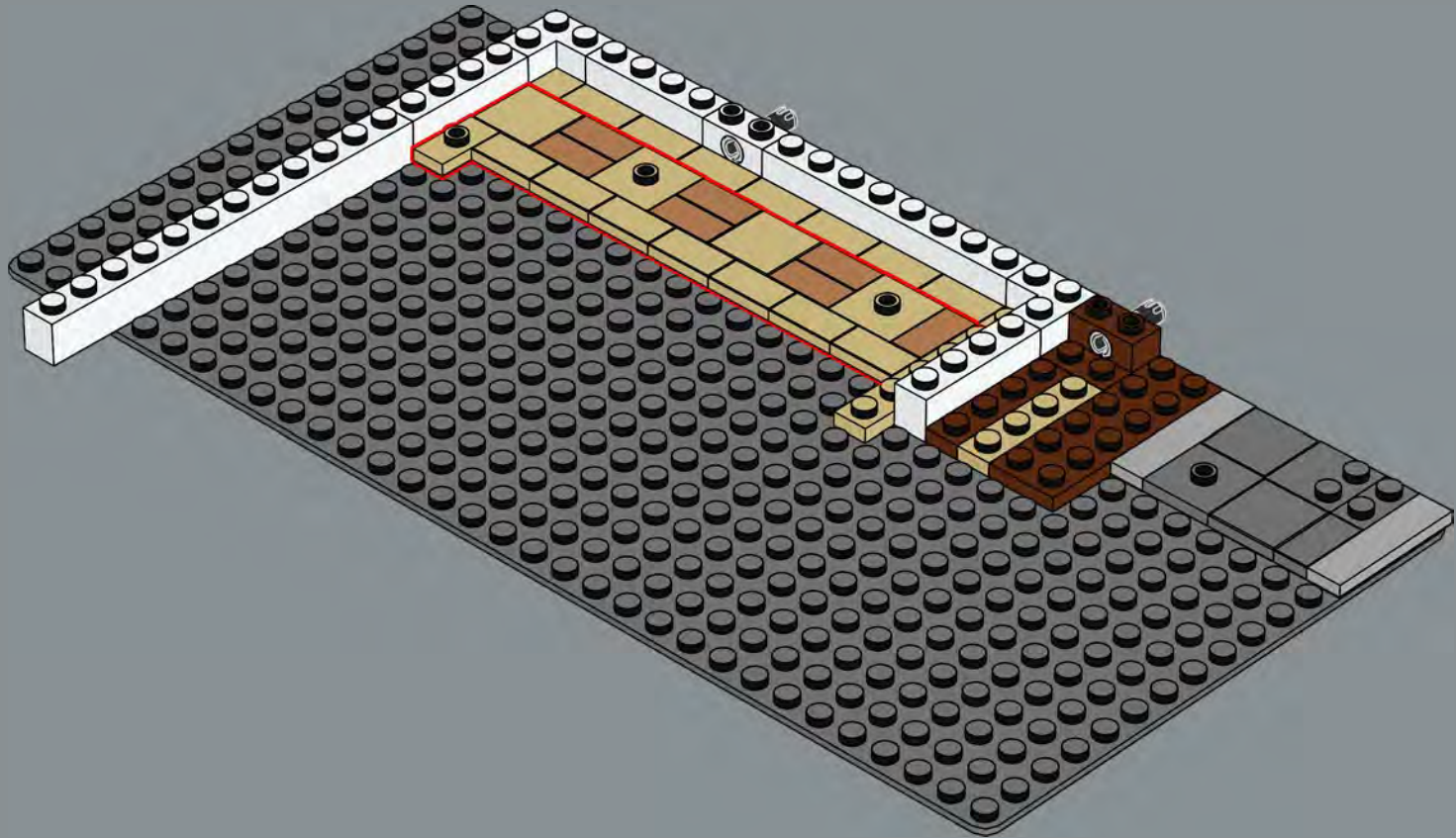



6

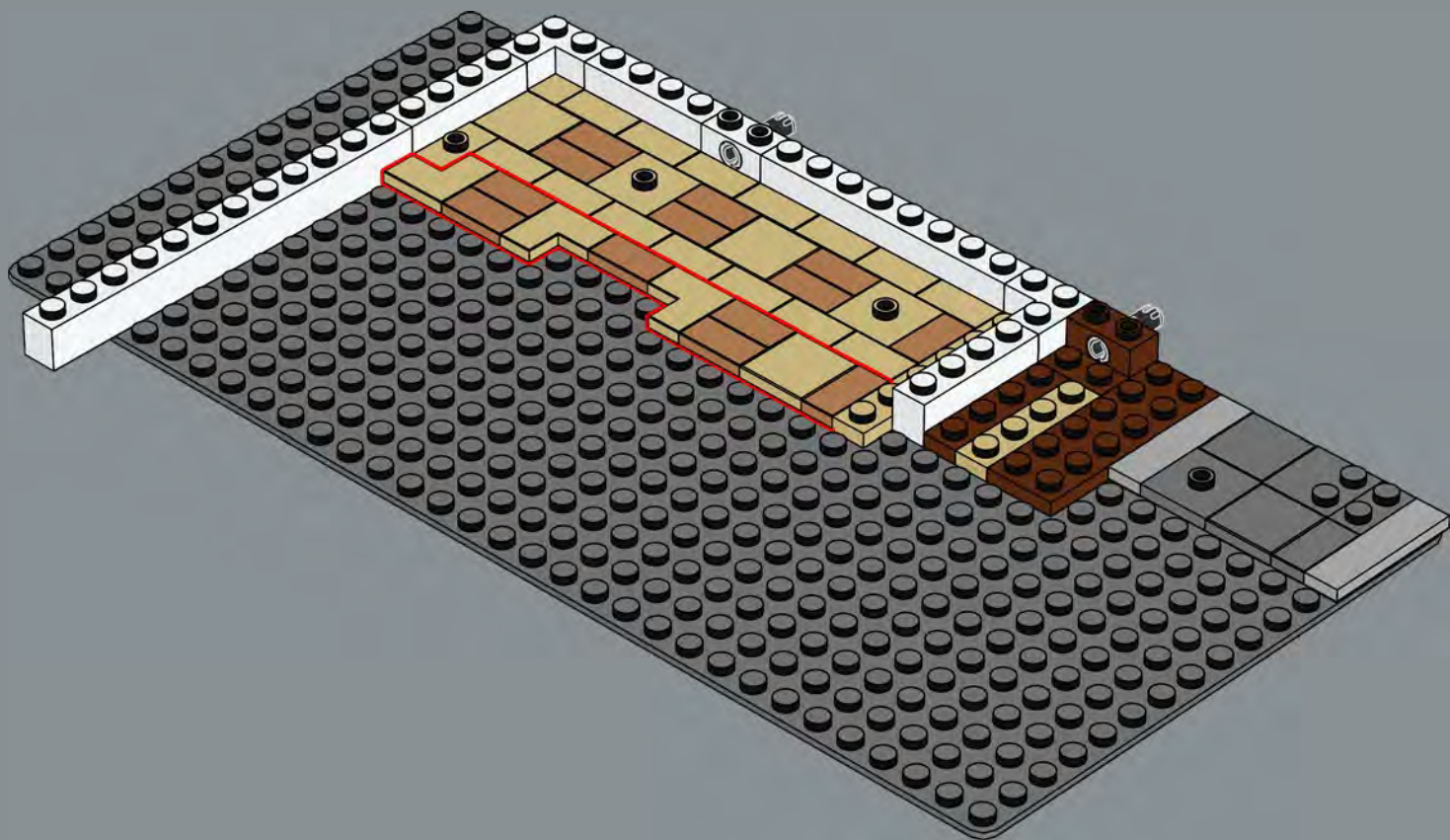

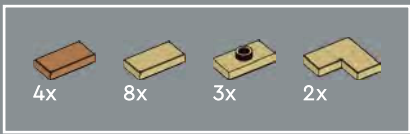

7

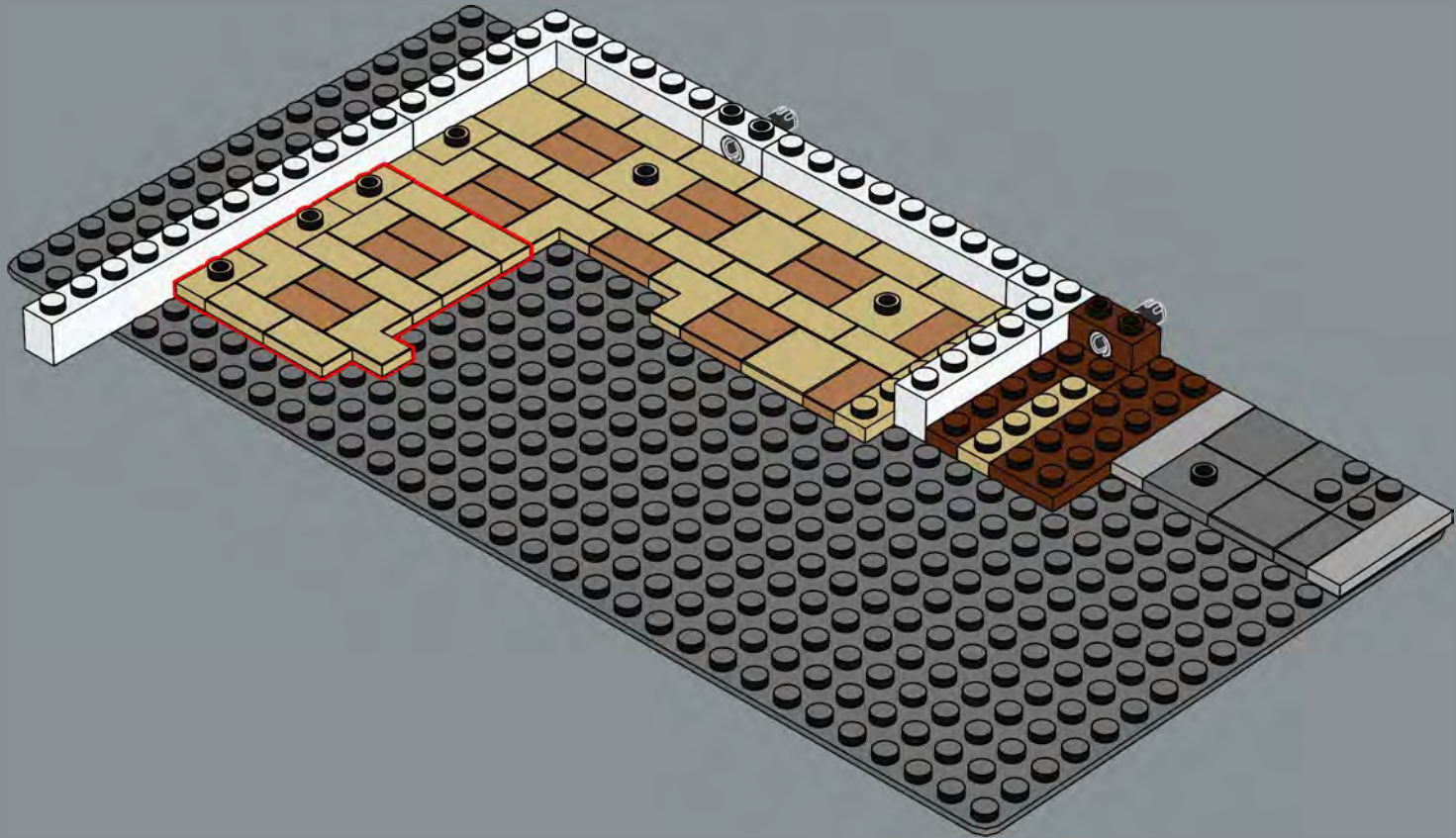

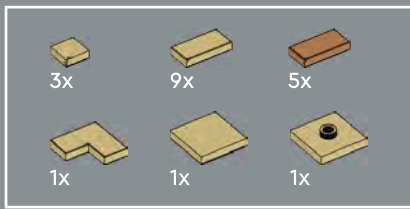

8

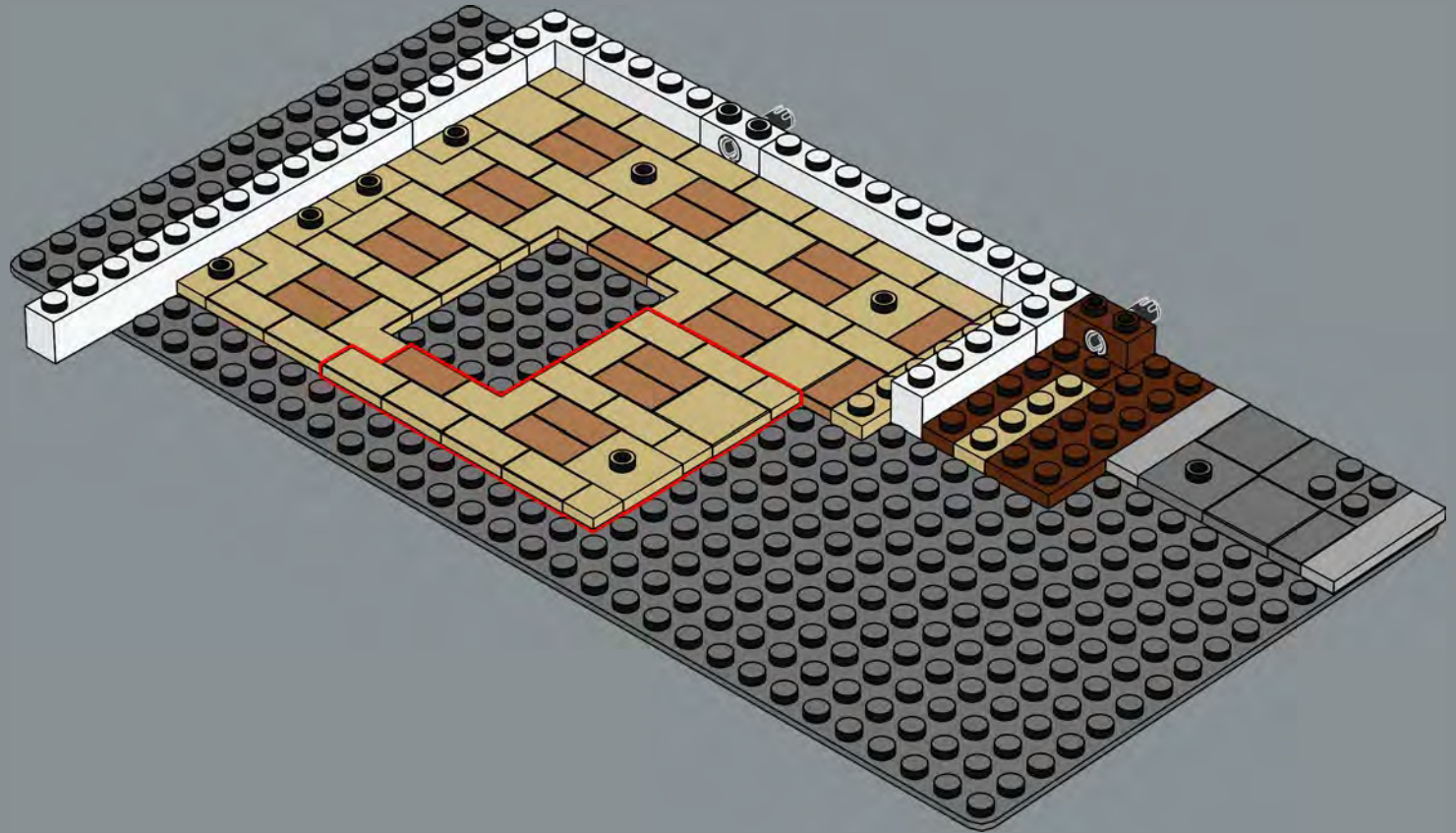

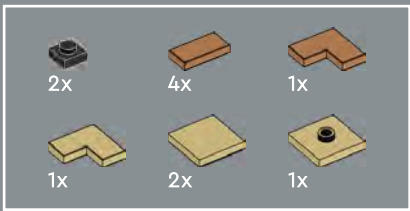

9

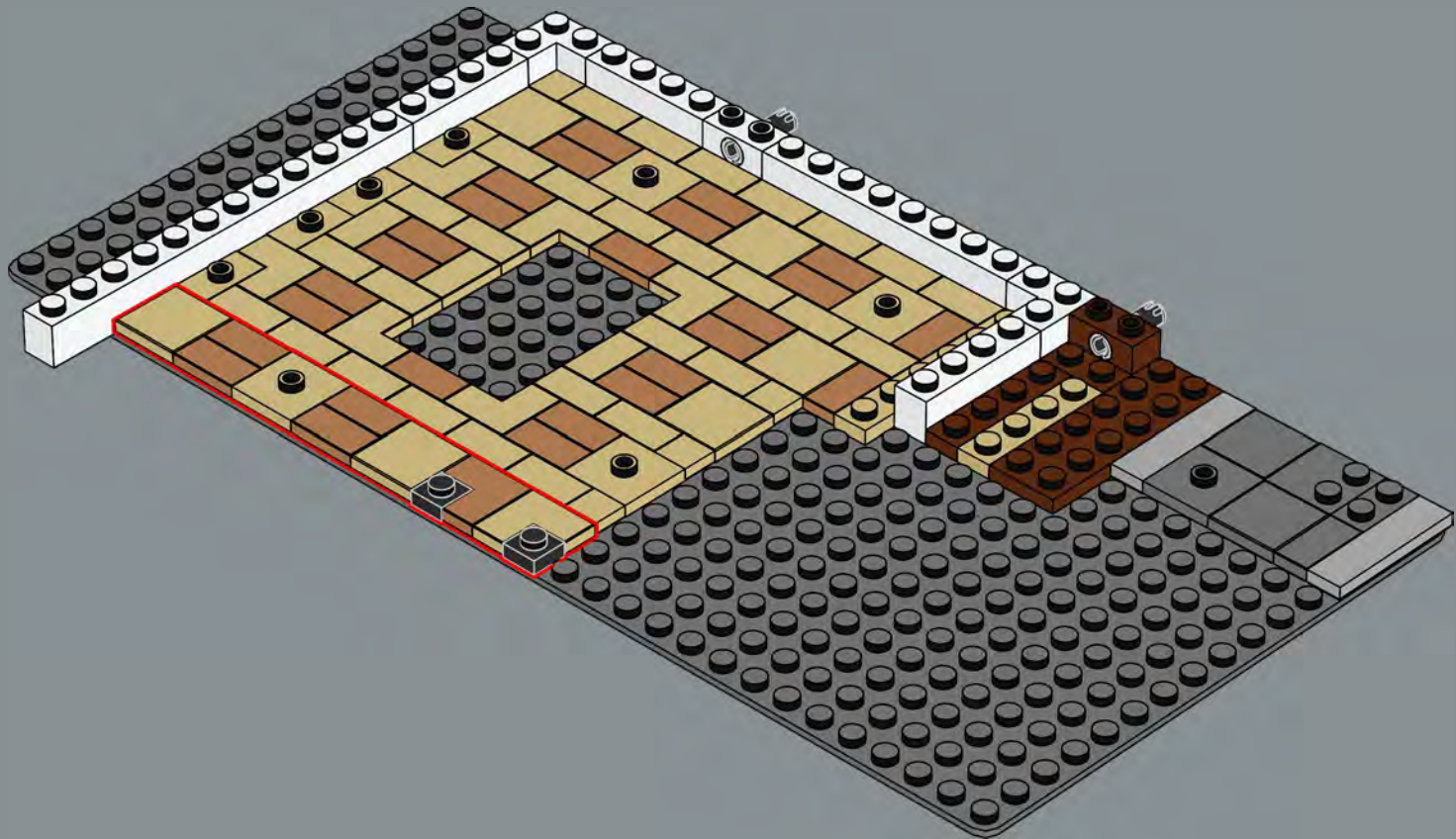

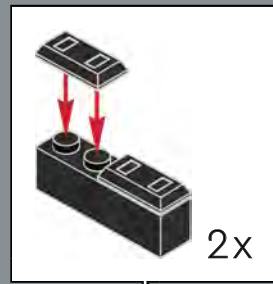
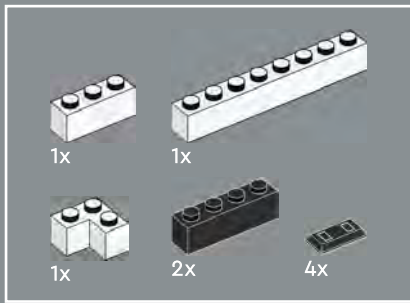

10

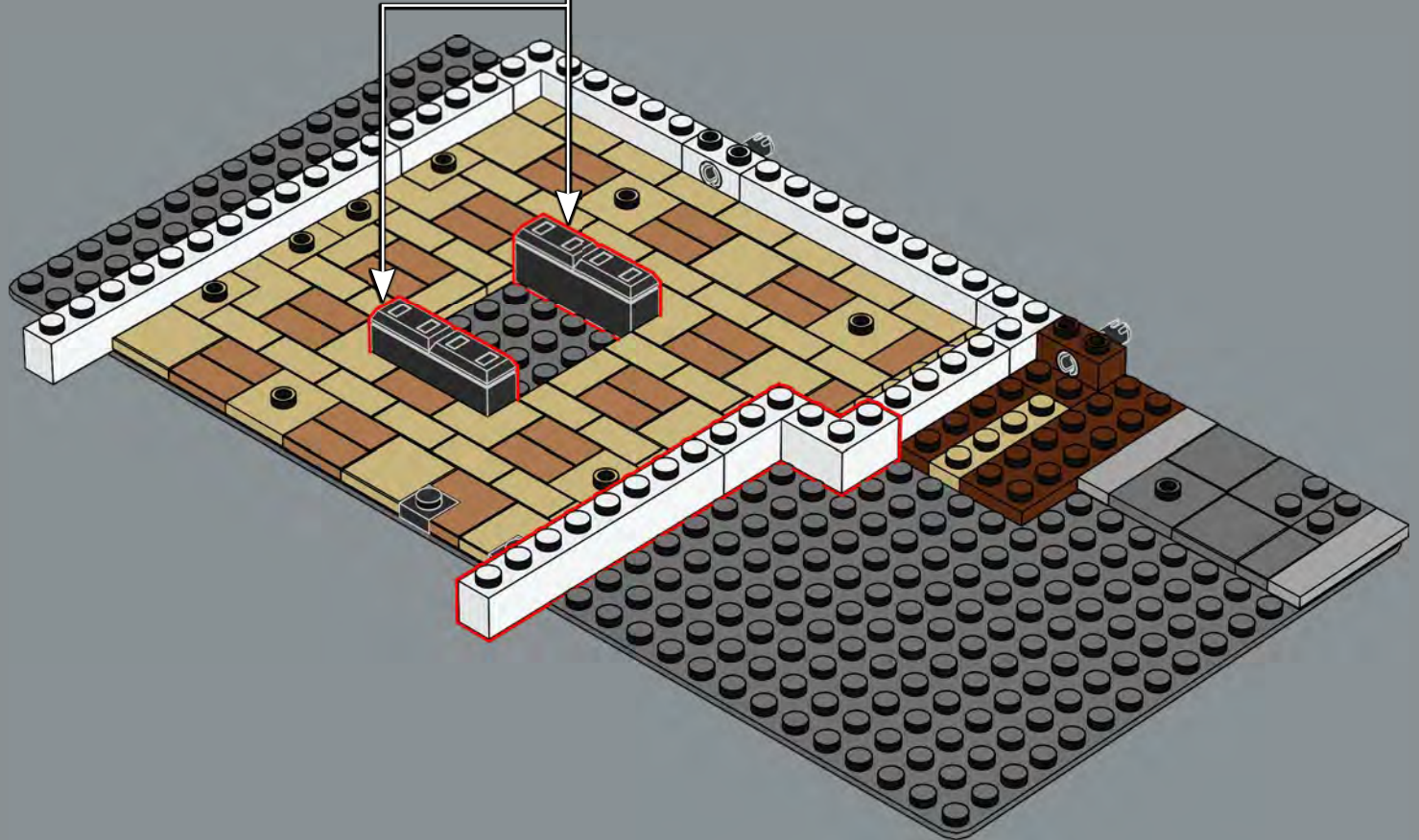

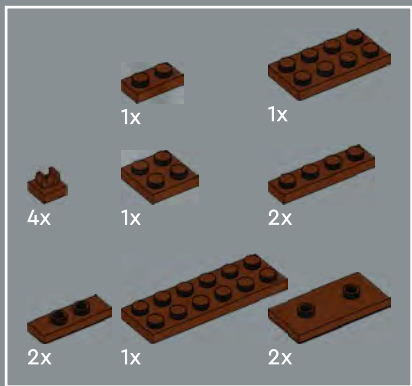

11

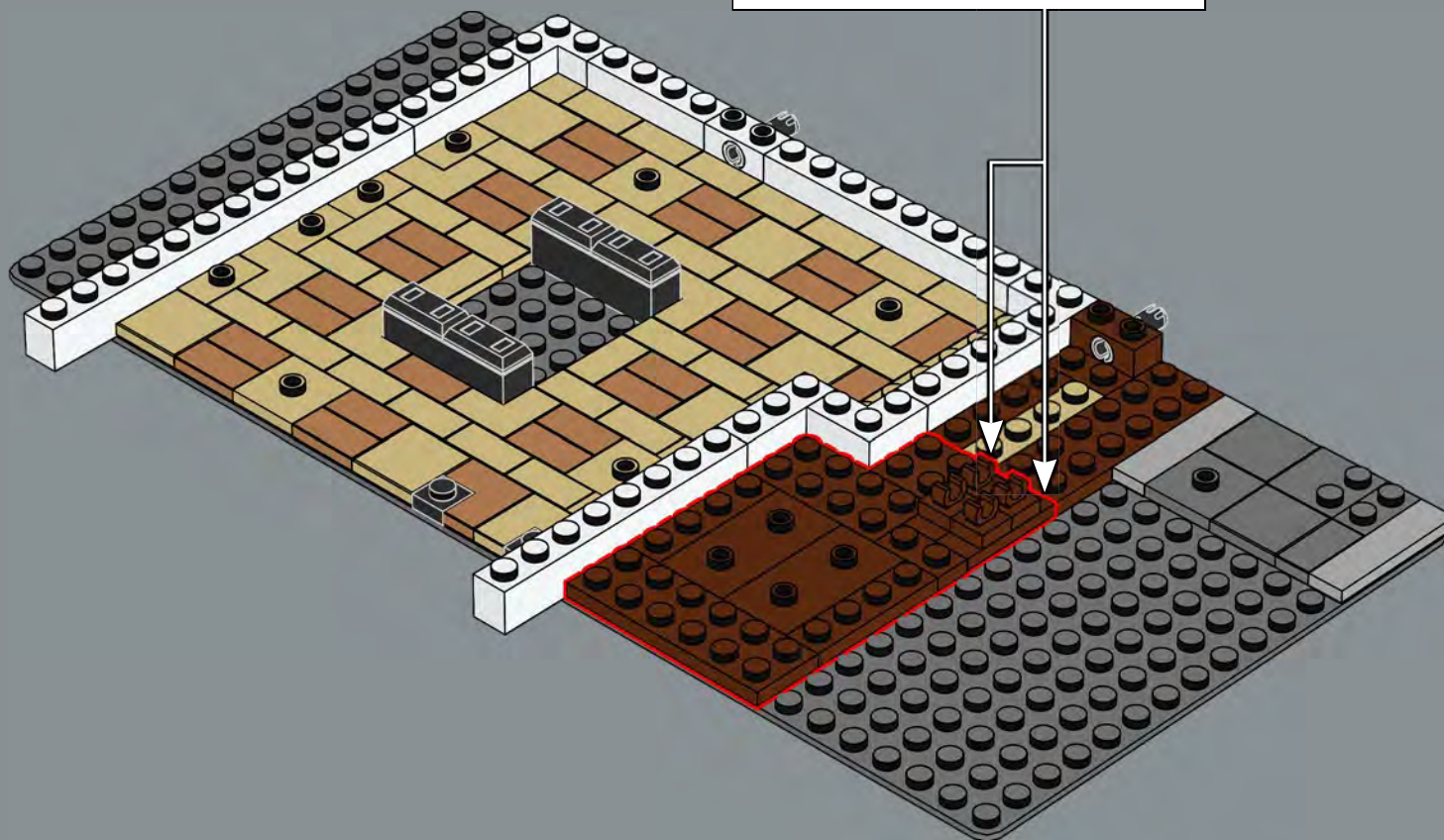
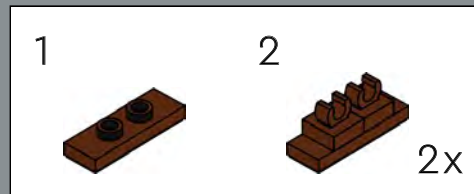

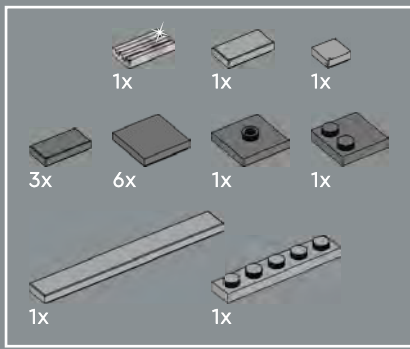

12

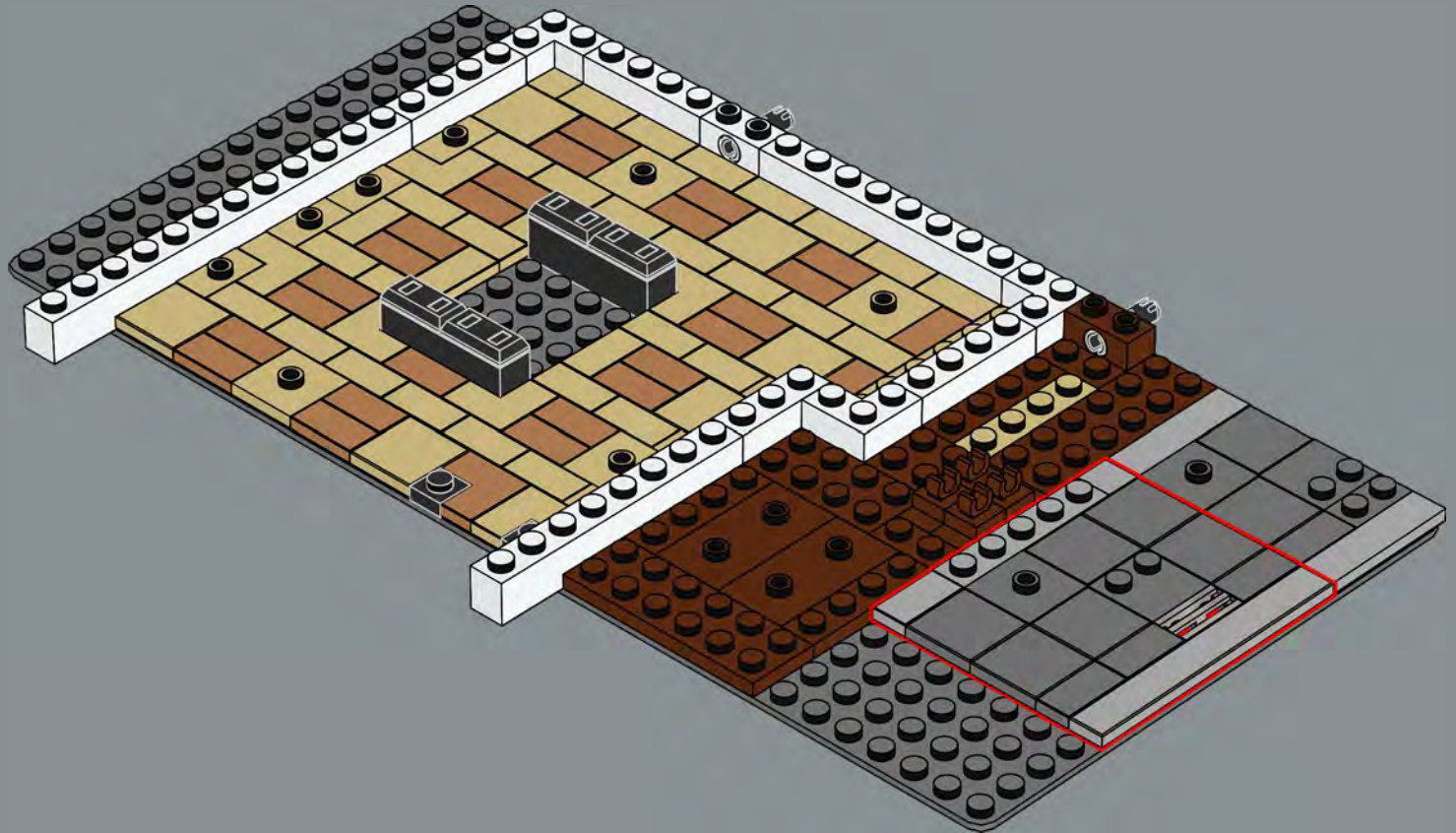



13

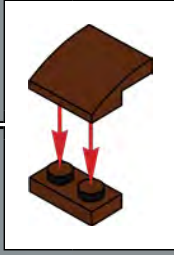
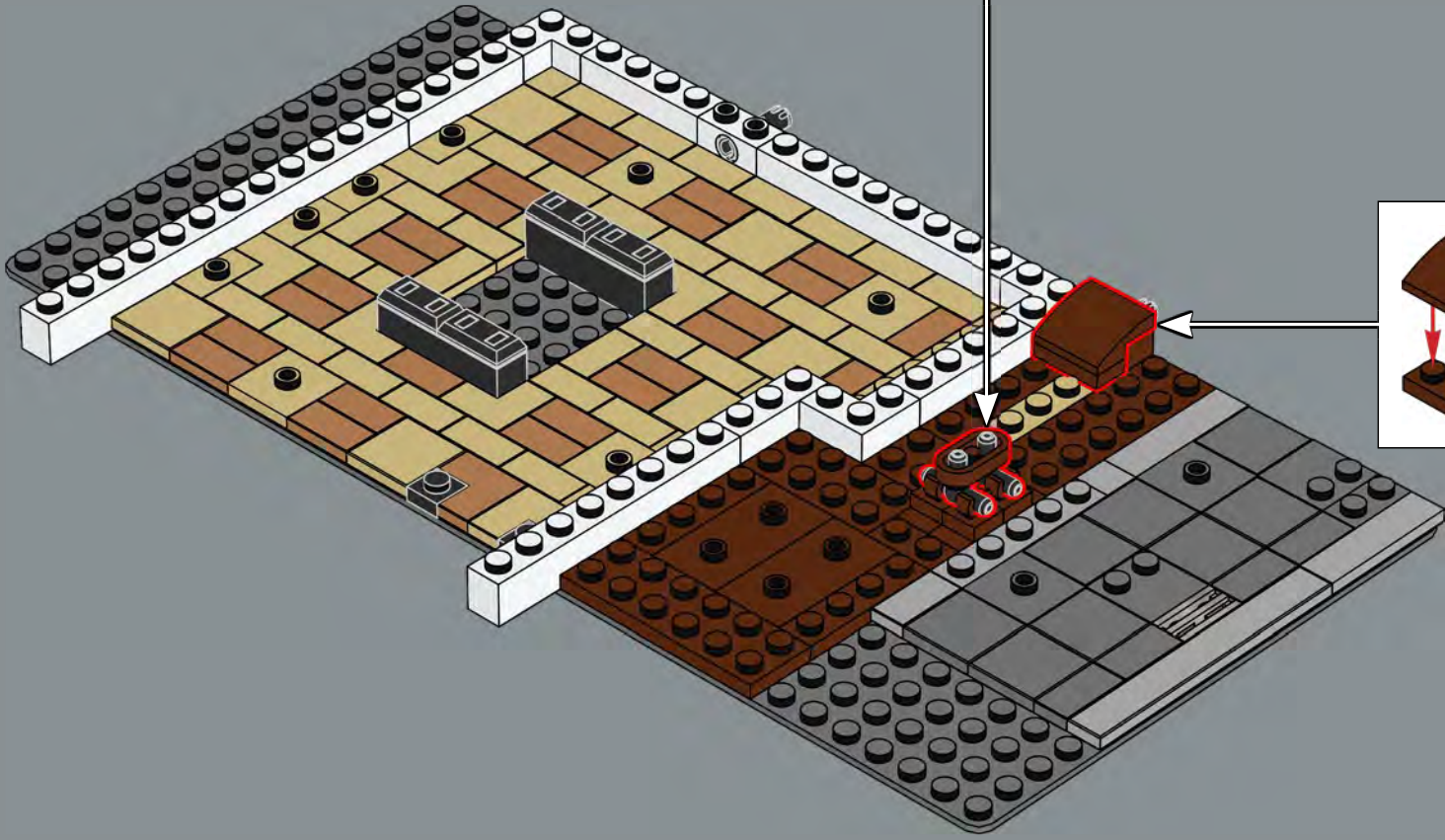
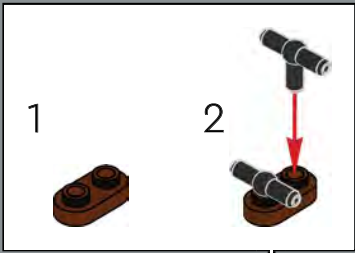

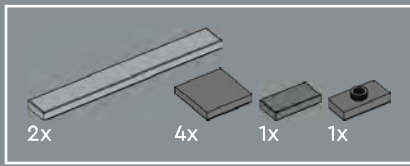

14

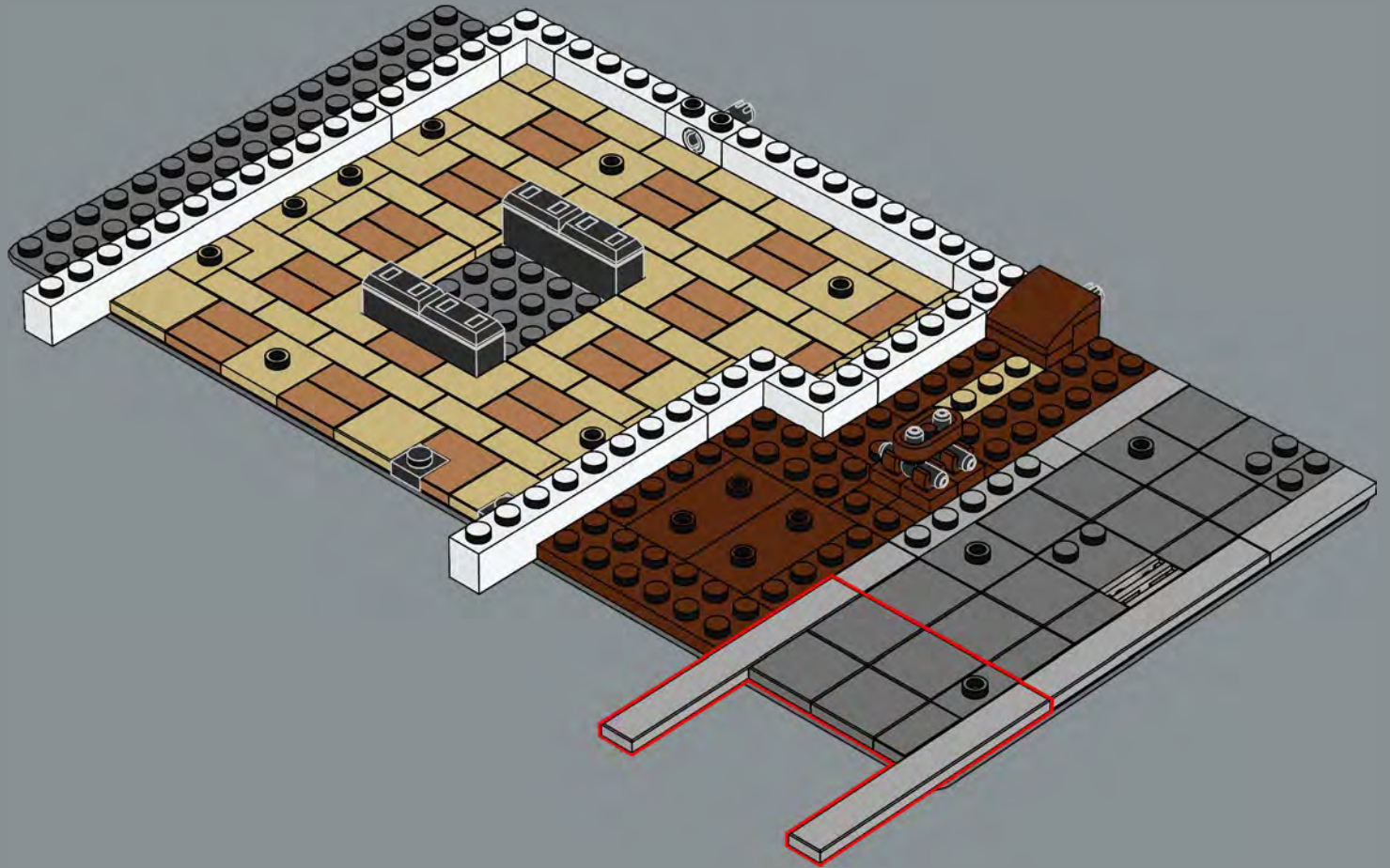

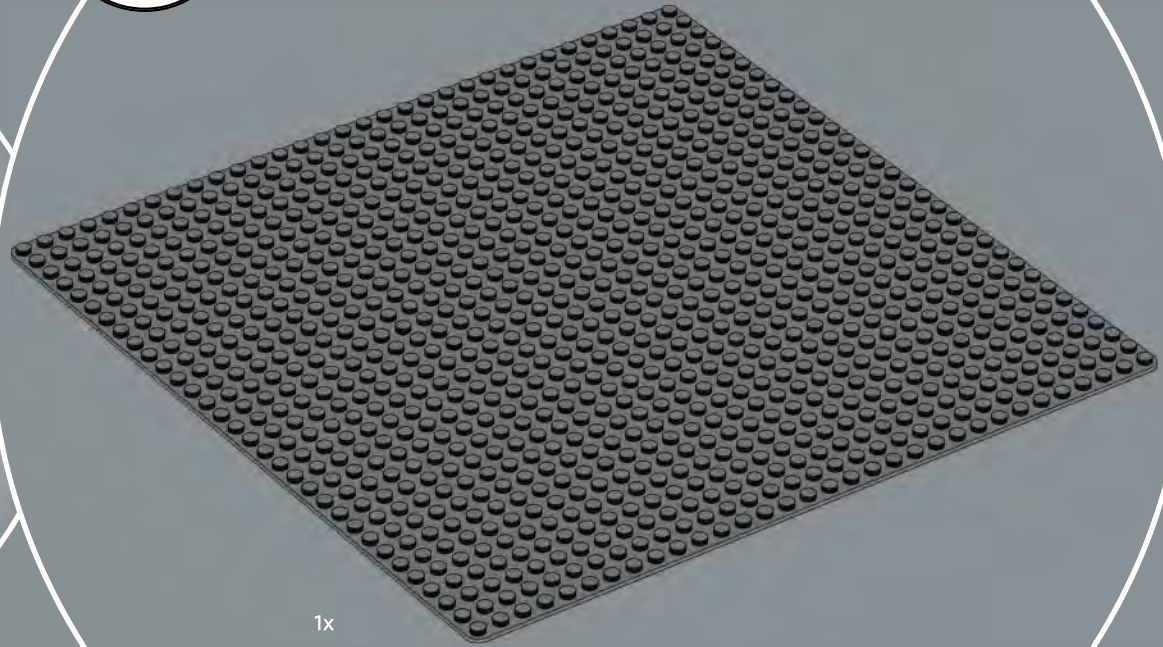
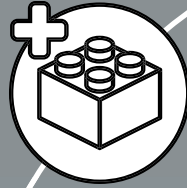

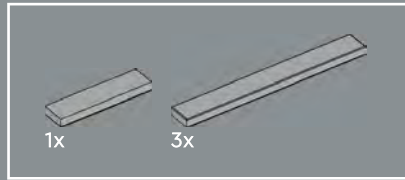
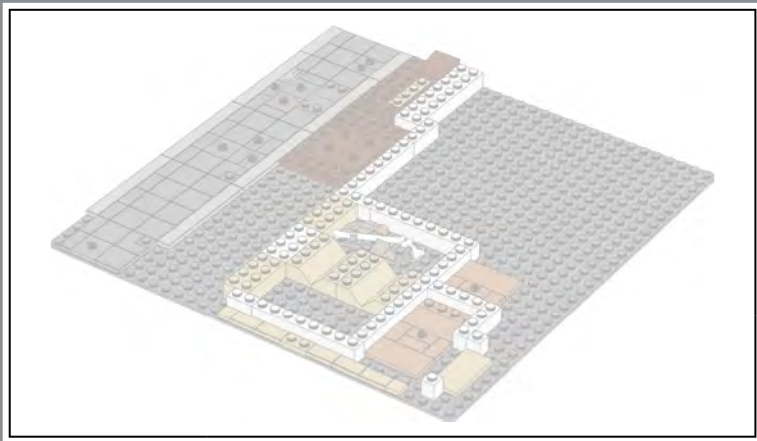

15

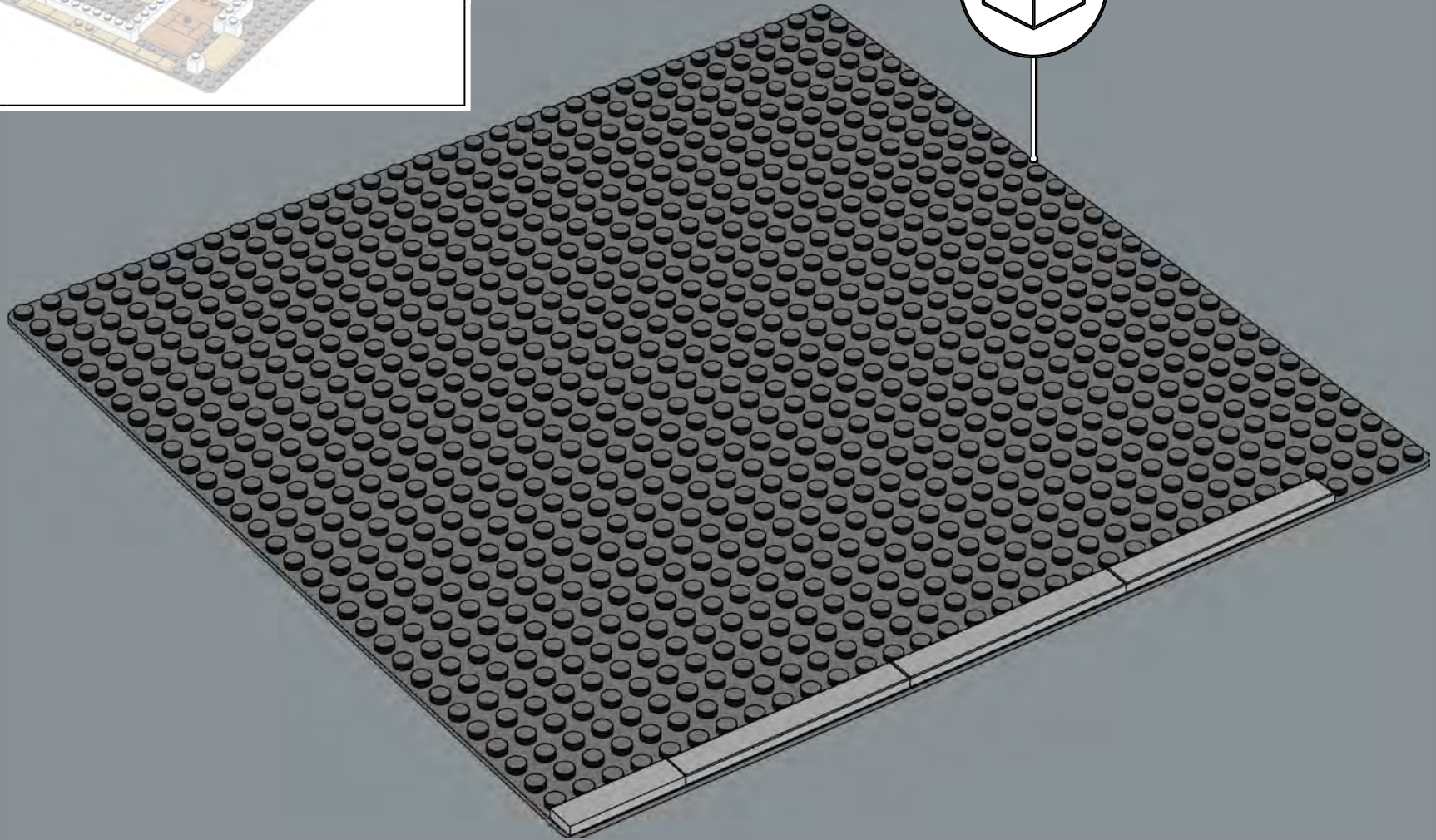
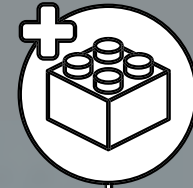

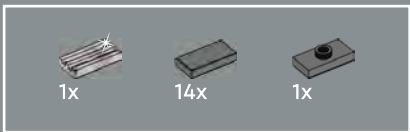

16

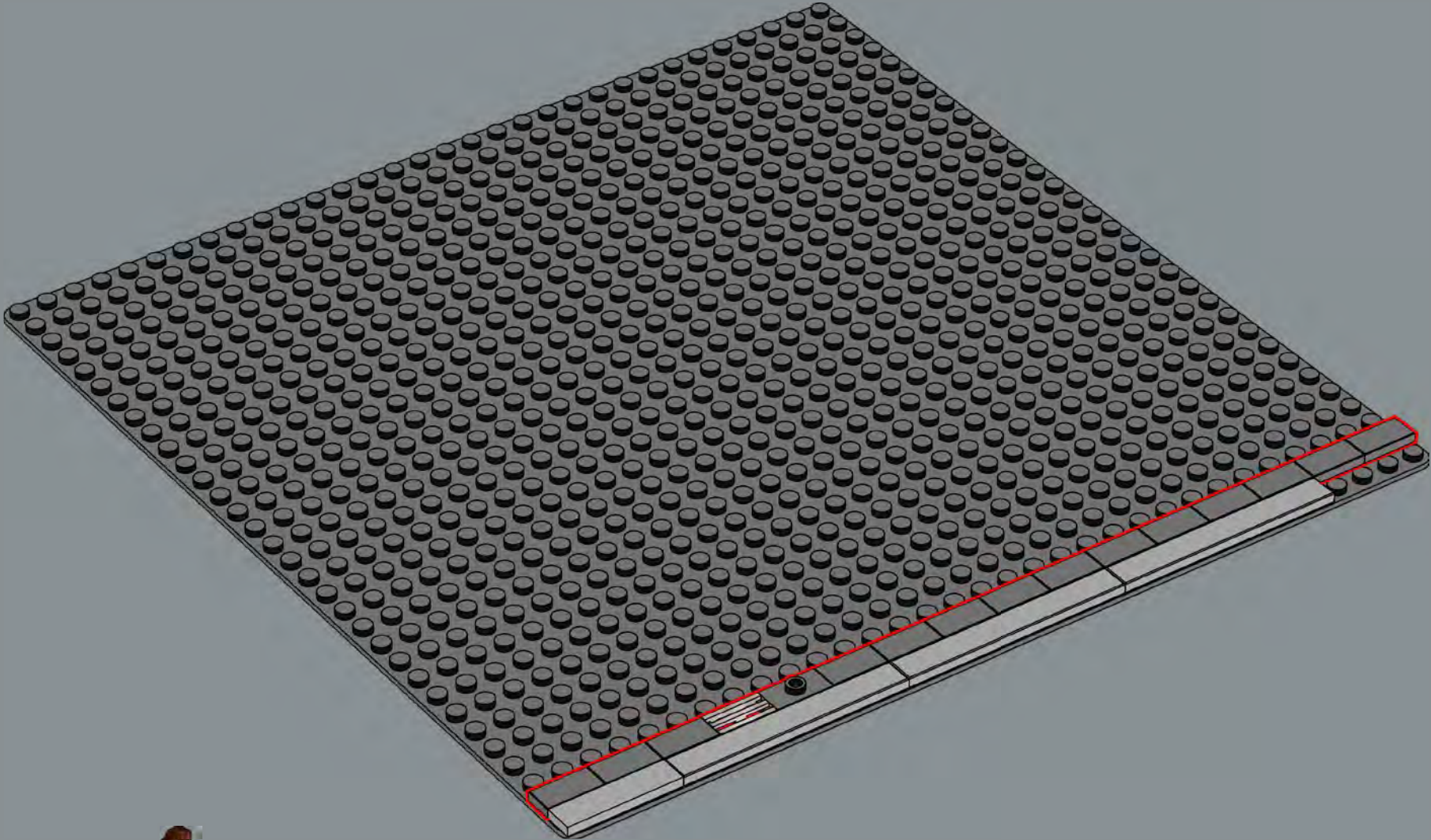

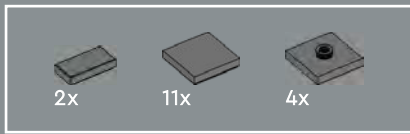

17

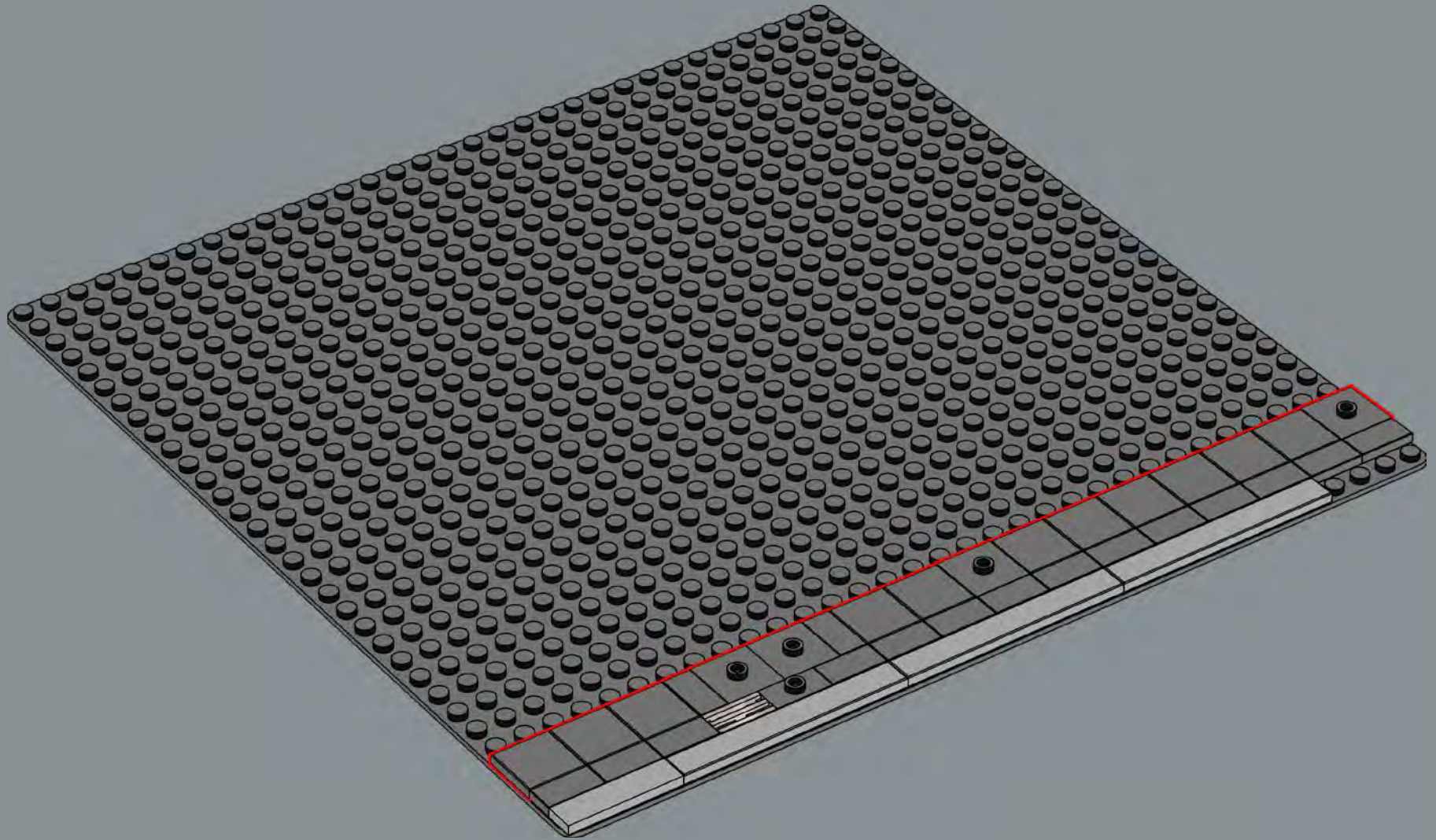

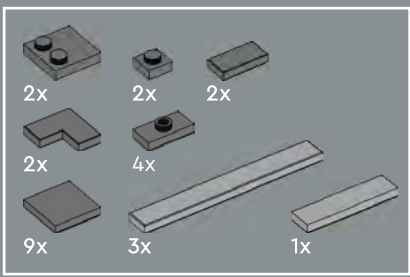

18

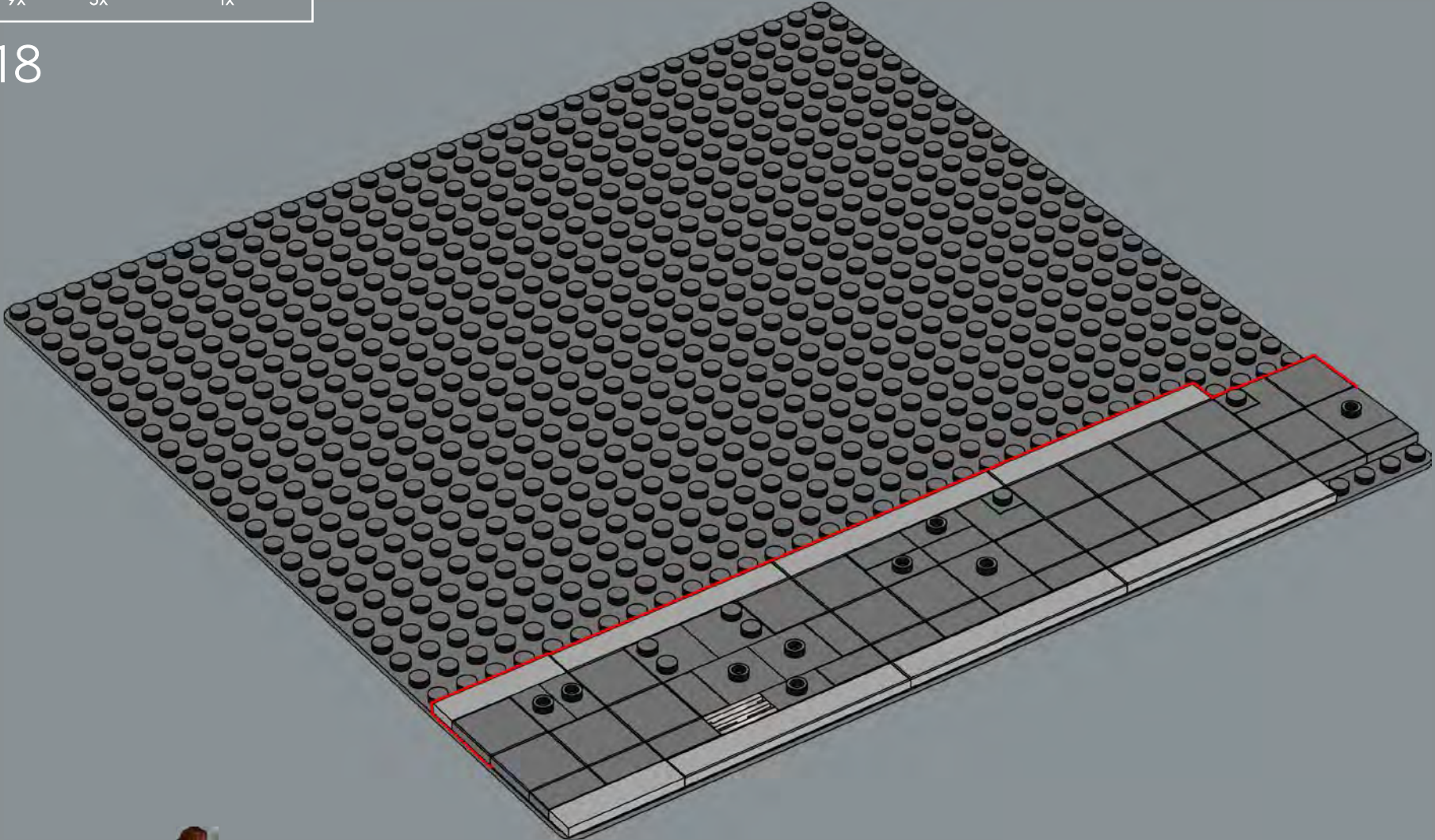

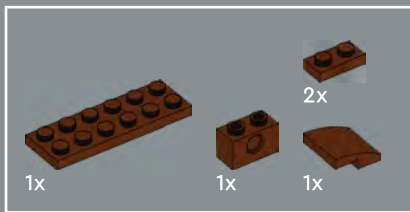

19

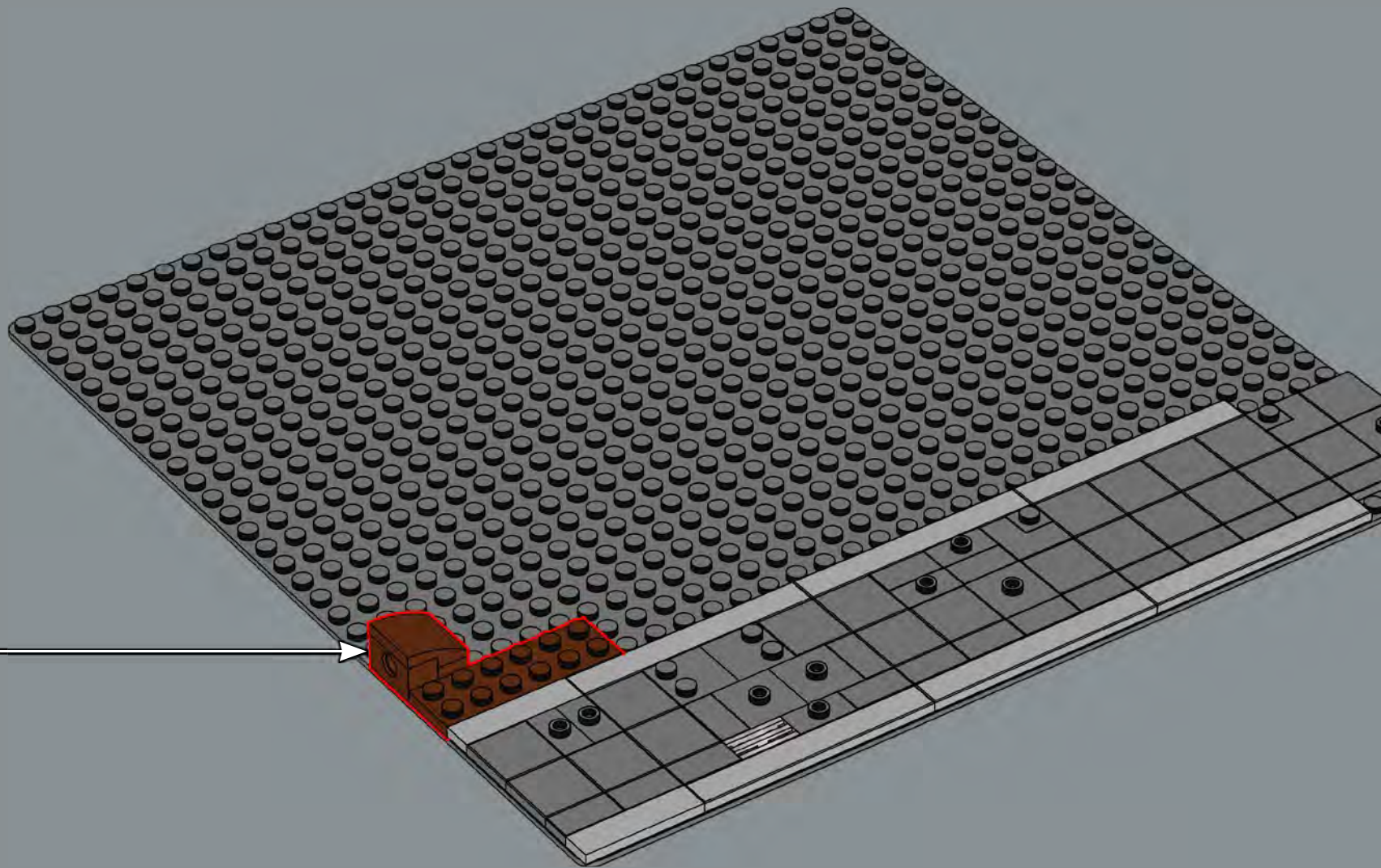
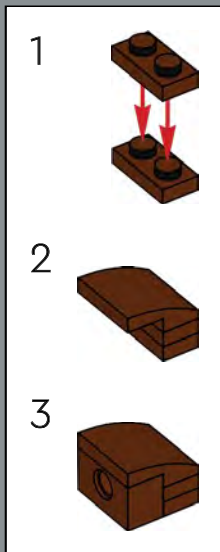

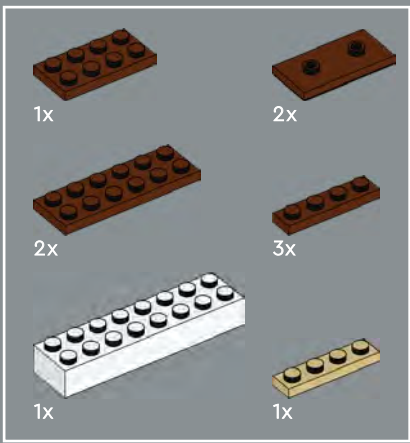

20

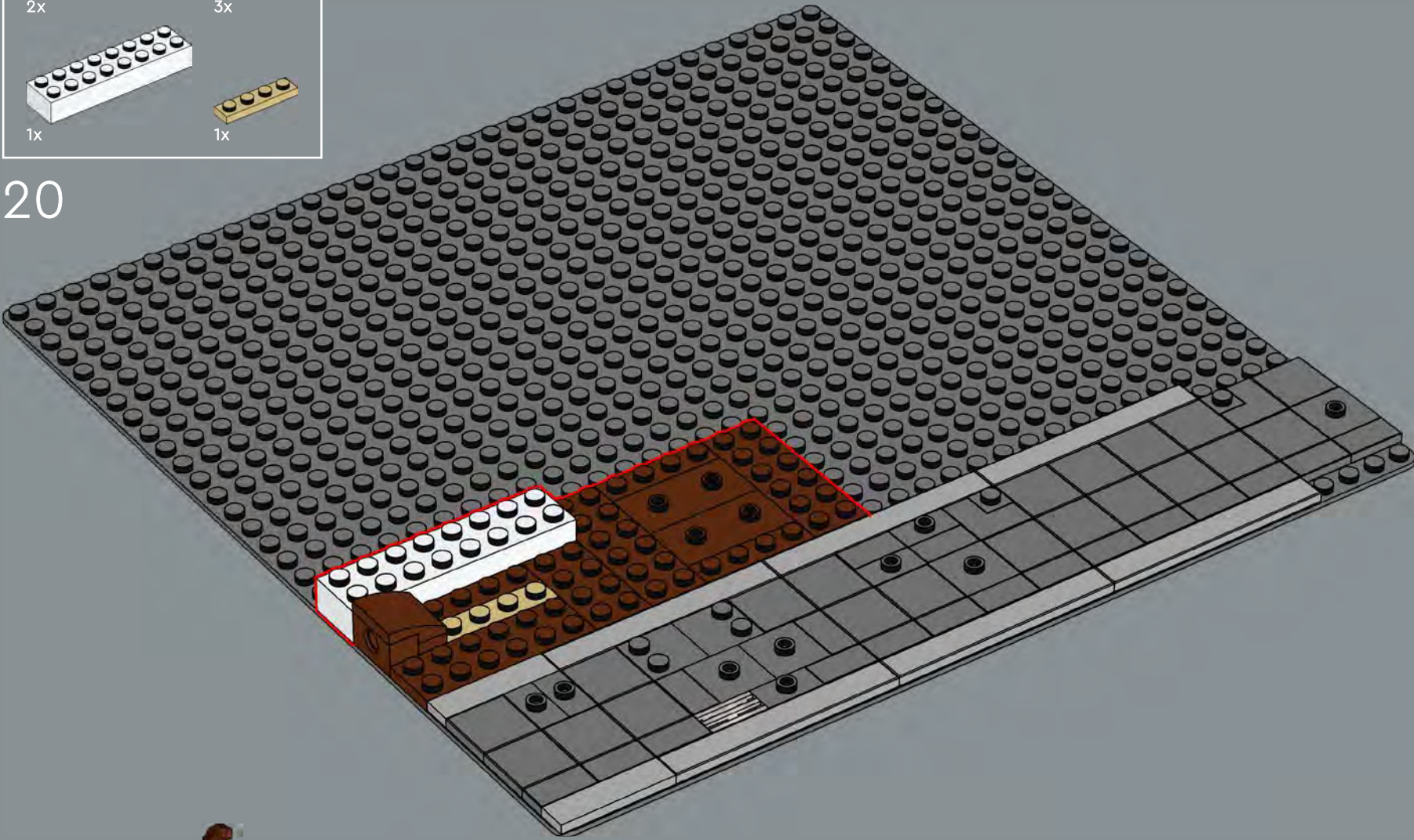

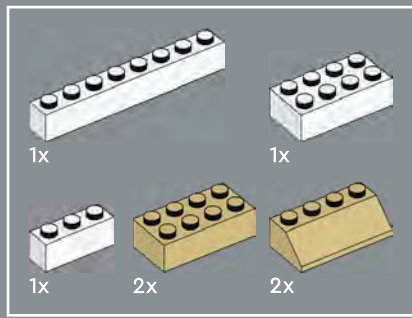

21

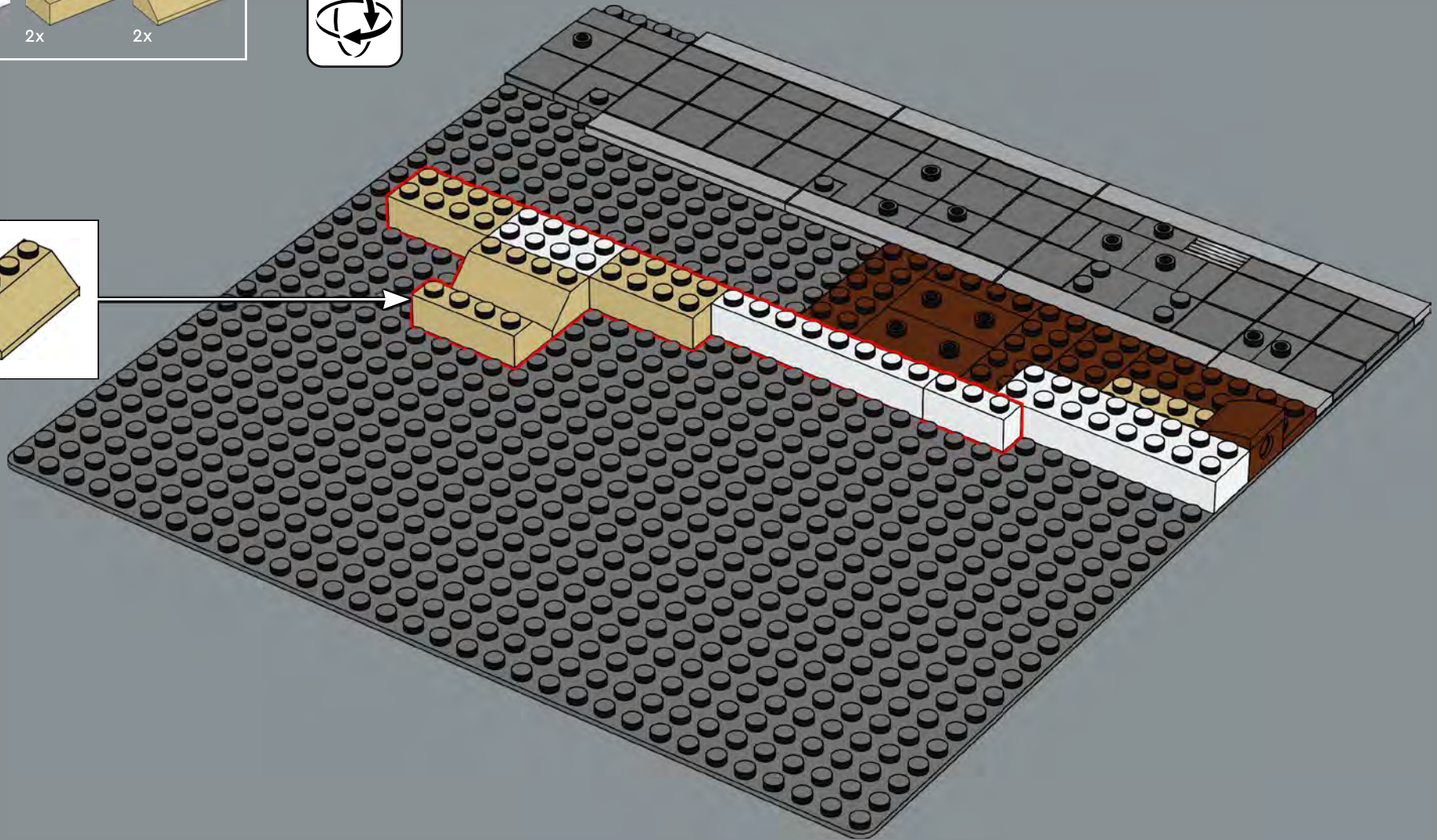
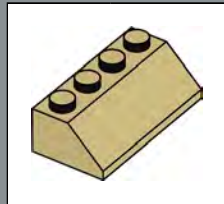

- 6x
- 3x
- 2x

22

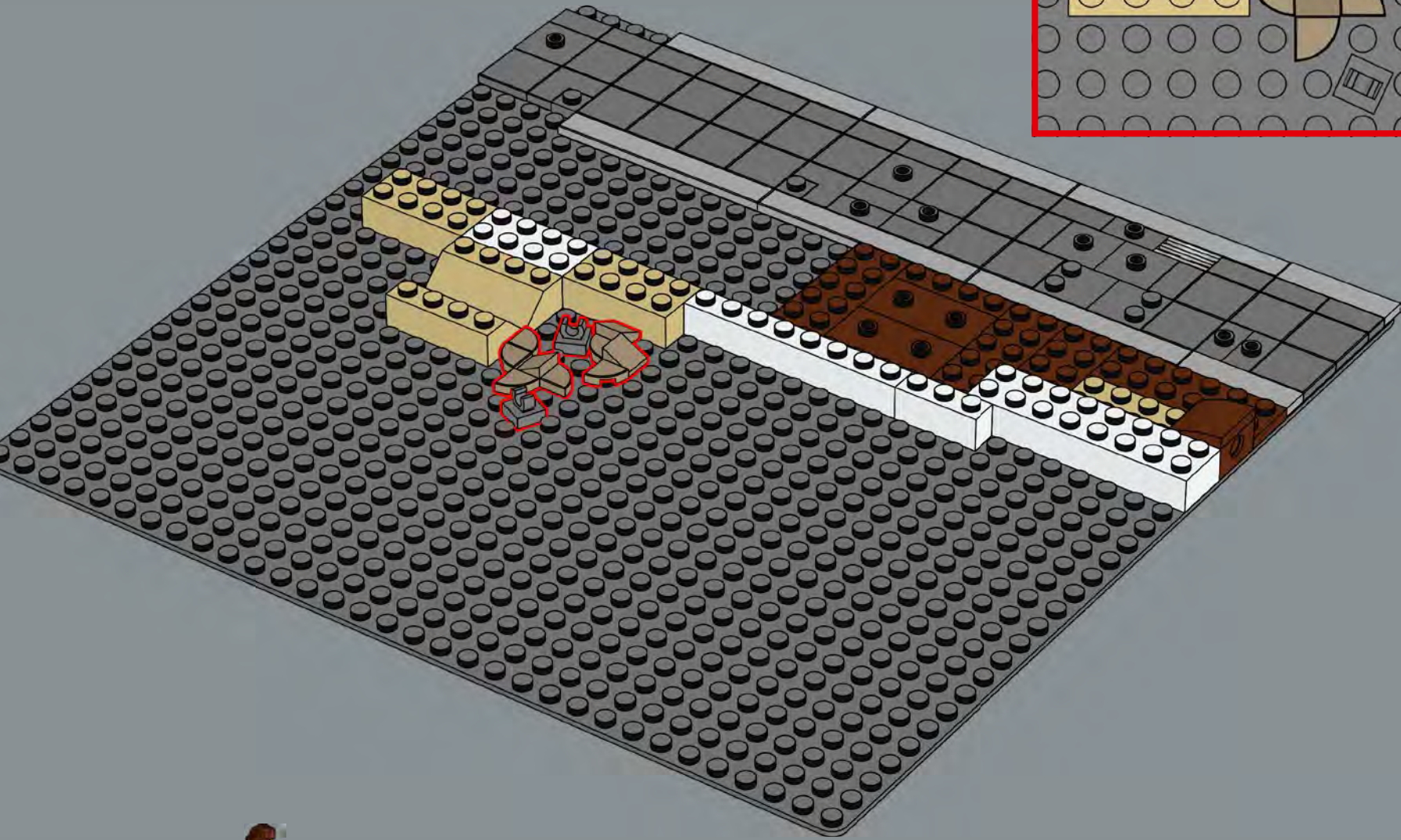
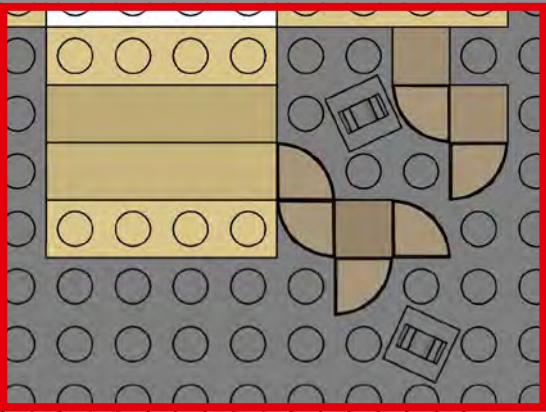



23

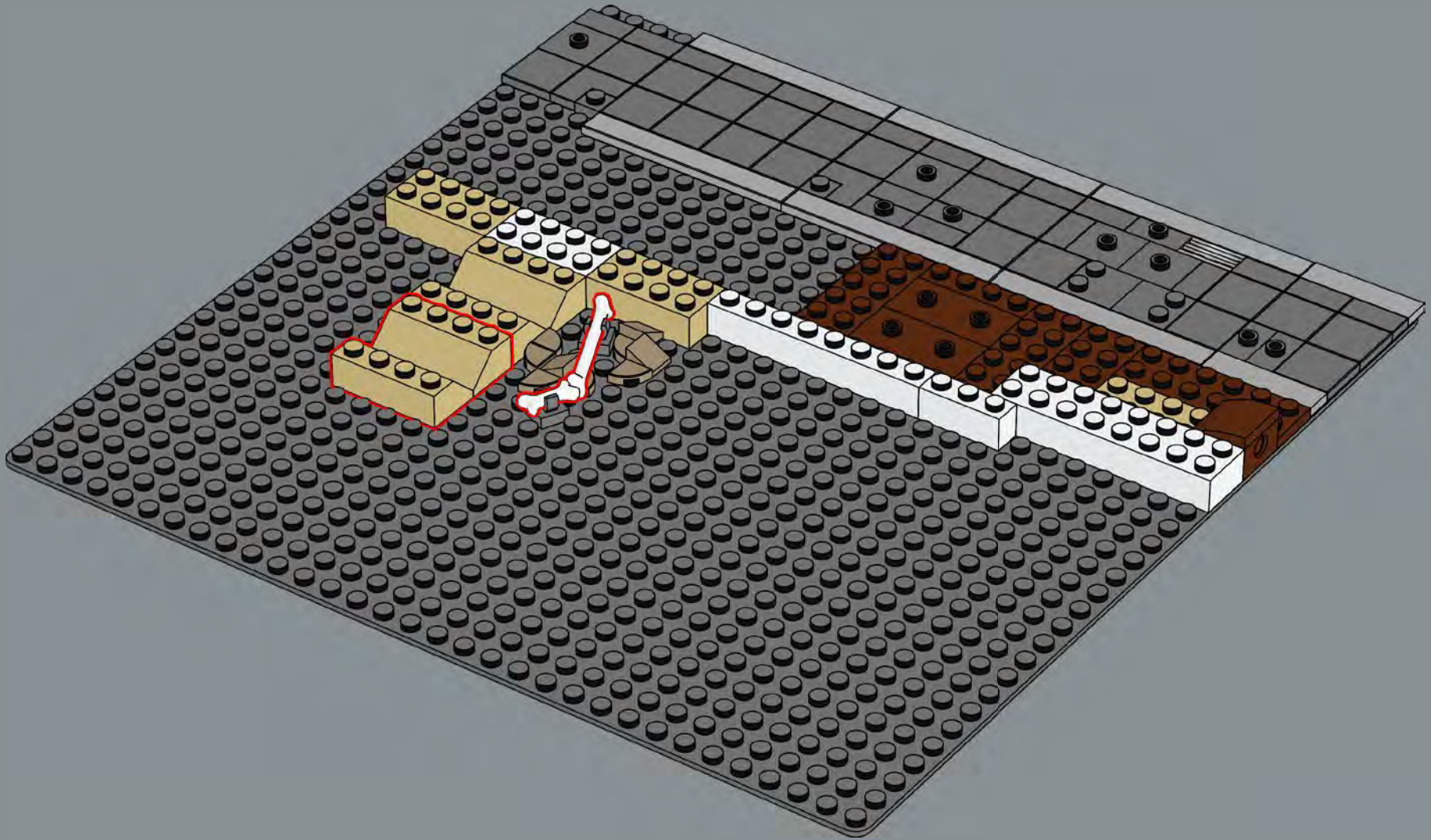

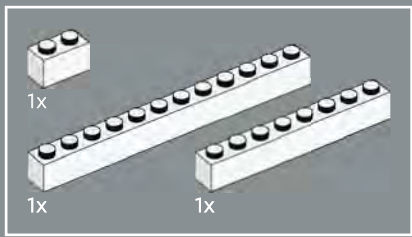

24

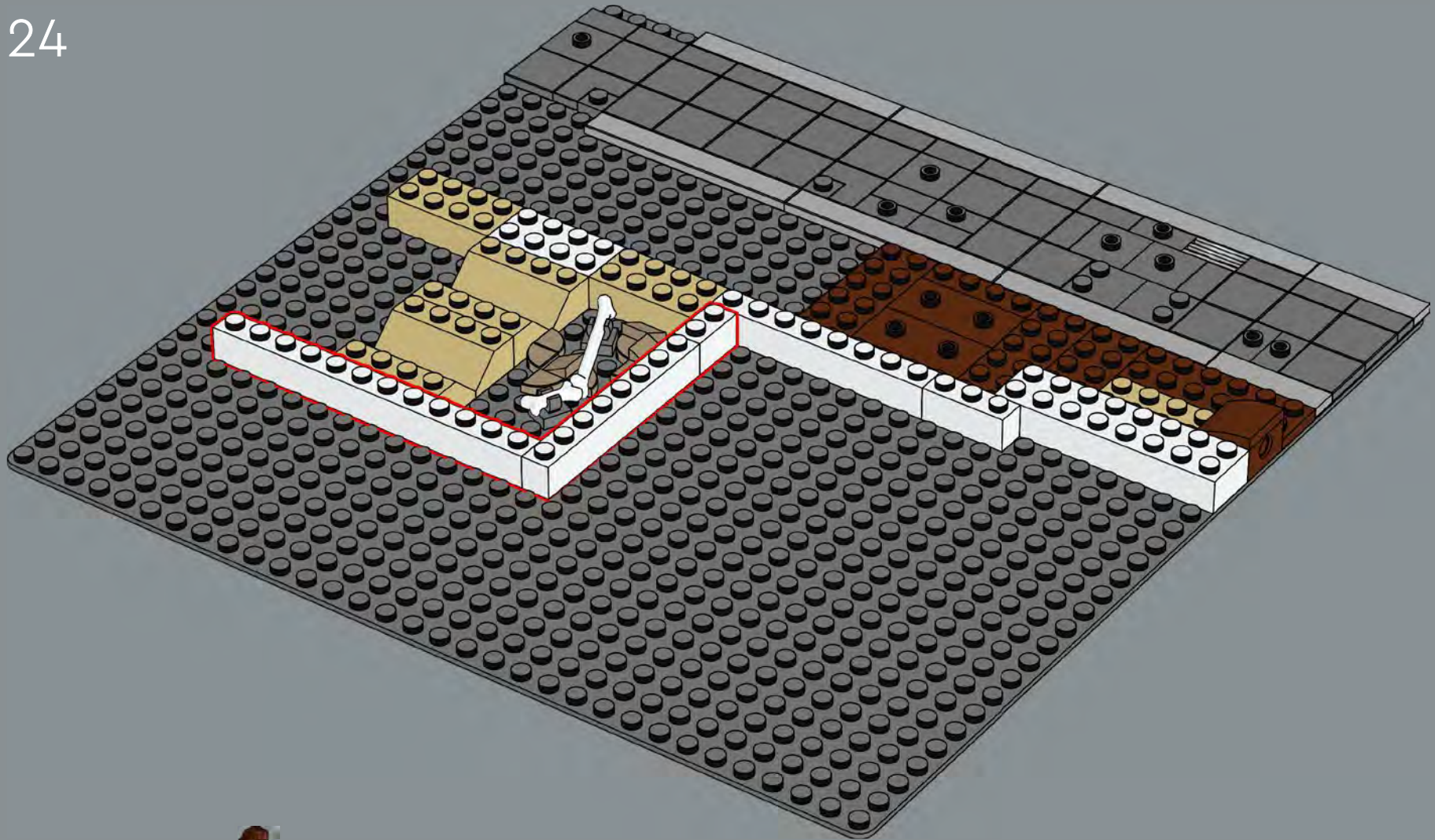

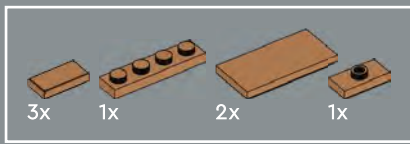

25

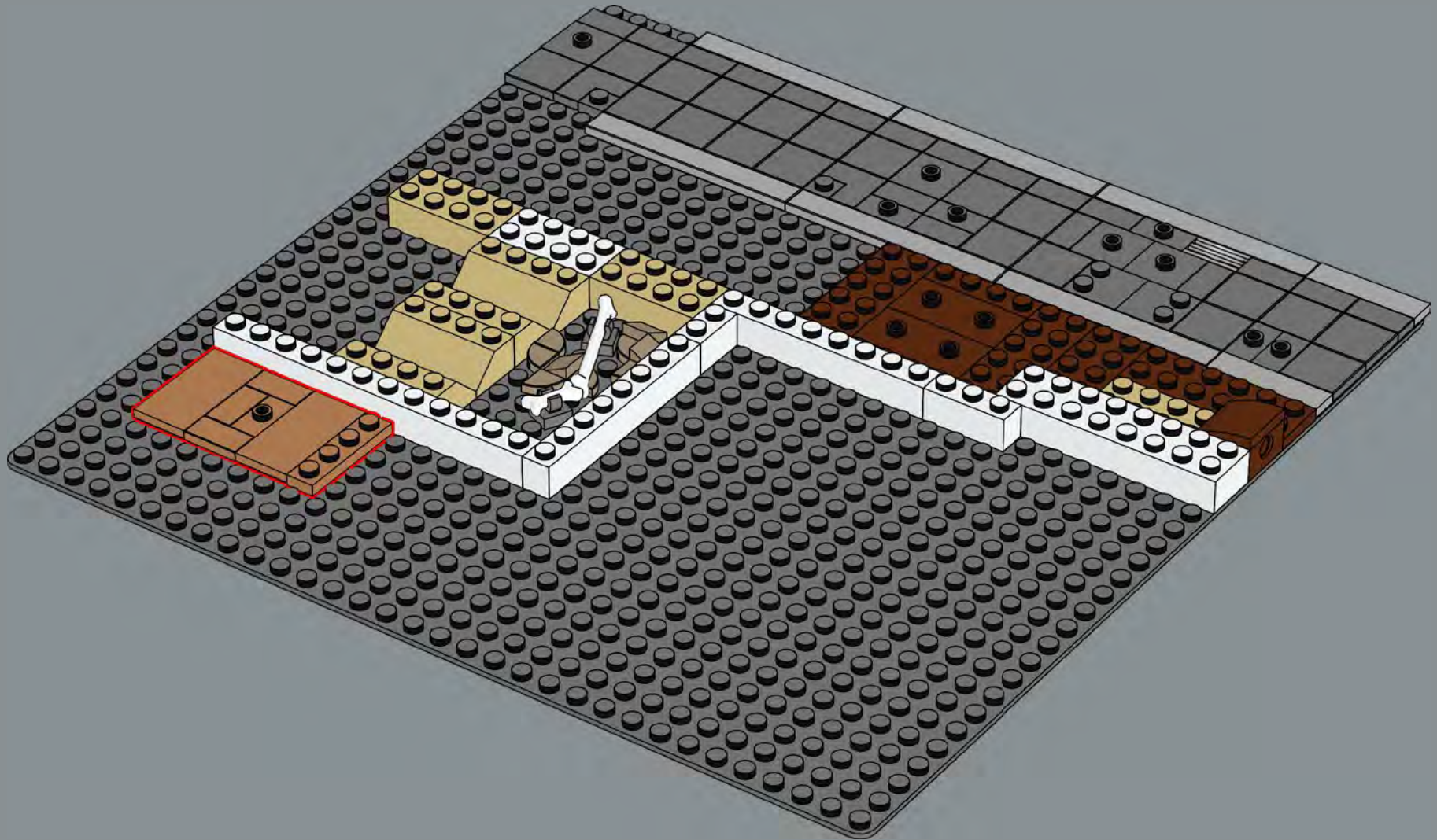

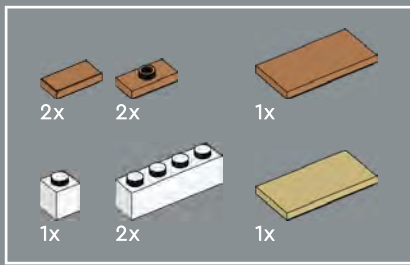

26

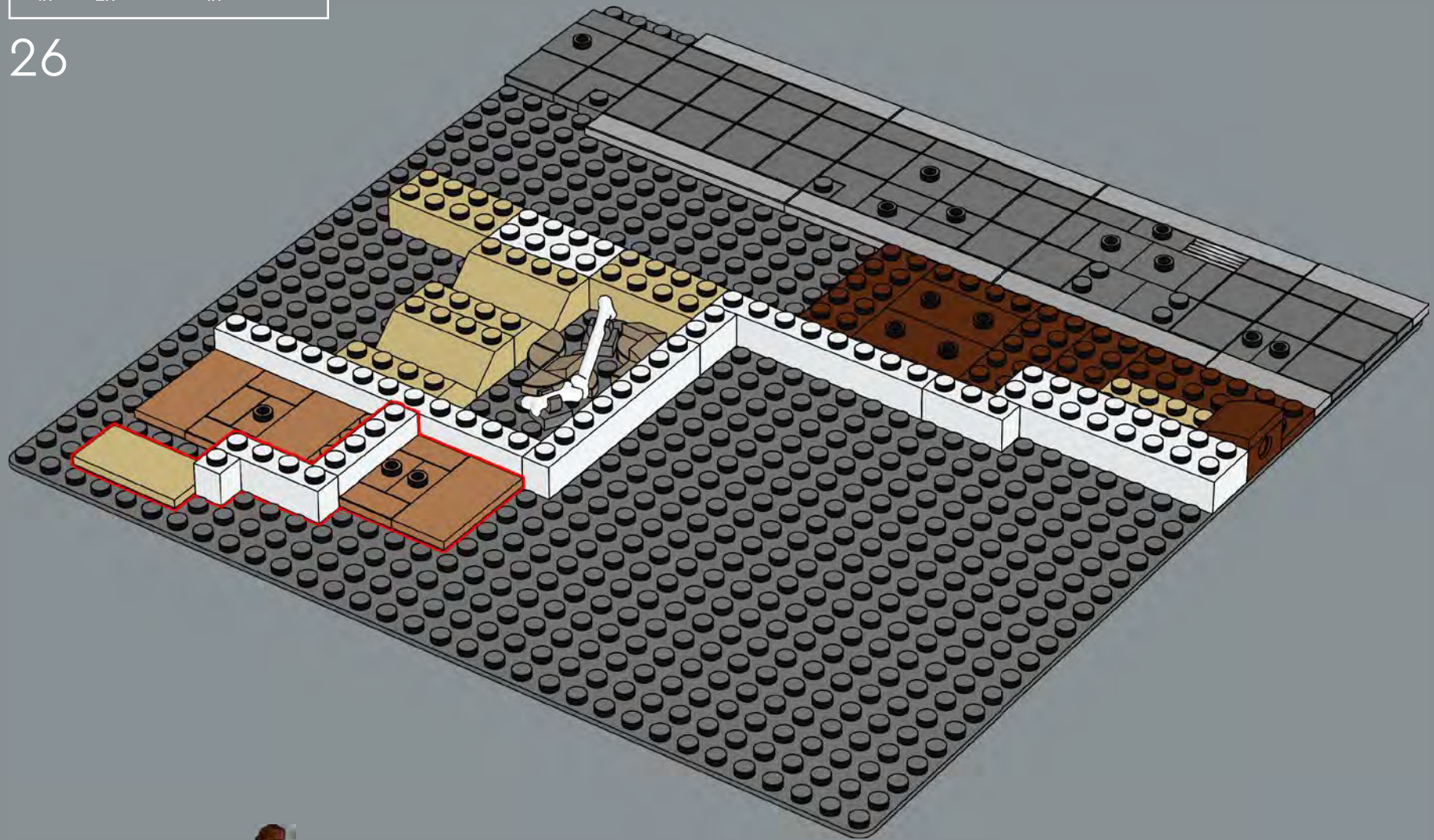

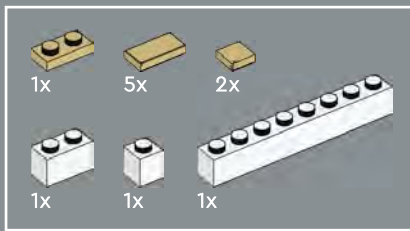

27

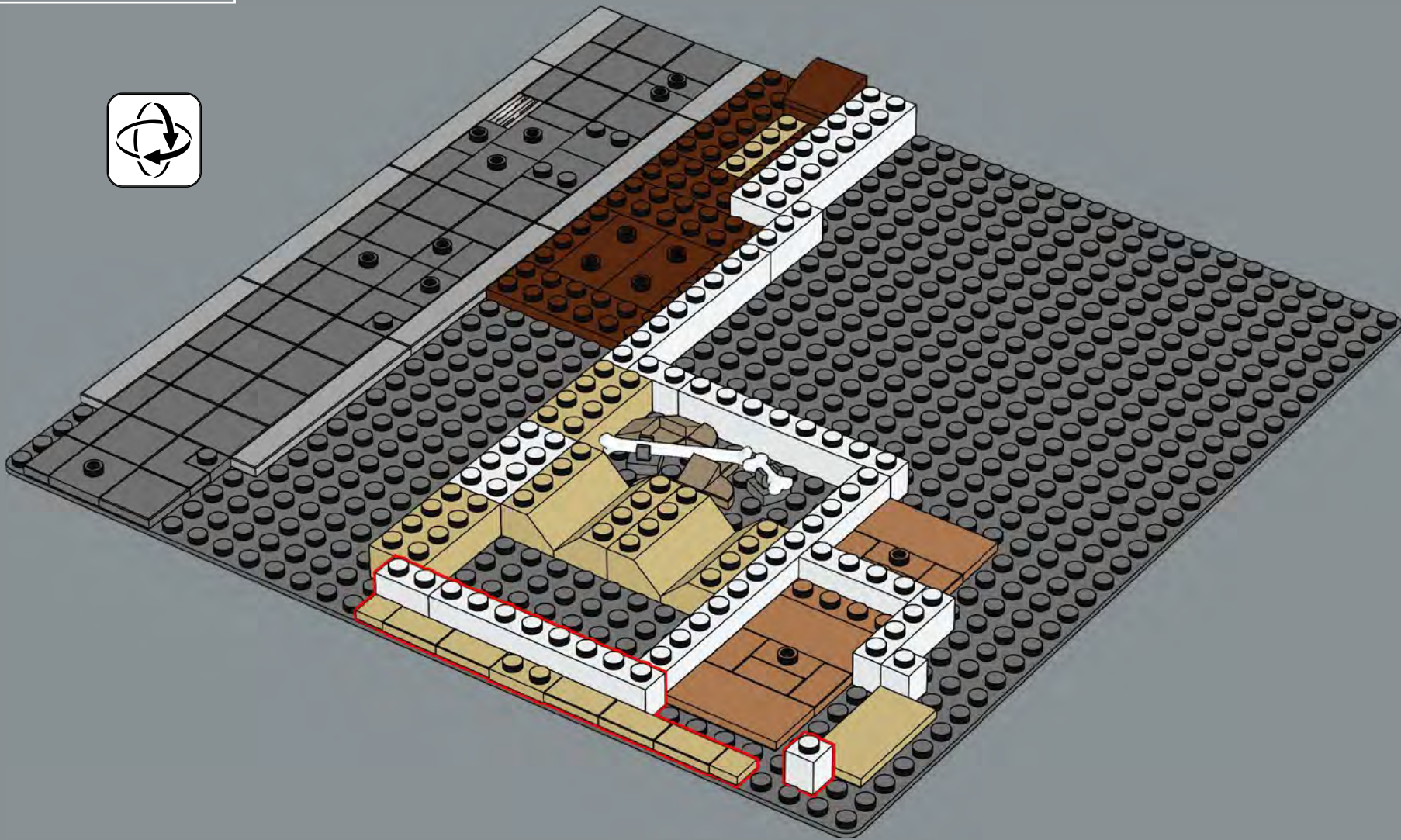

28



This is only the second time we have released a LEGO® modular building set with an expanded width (48 bricks wide instead of the standard 32 bricks).





- 1x
- 4x
- 3x
- 1x

29

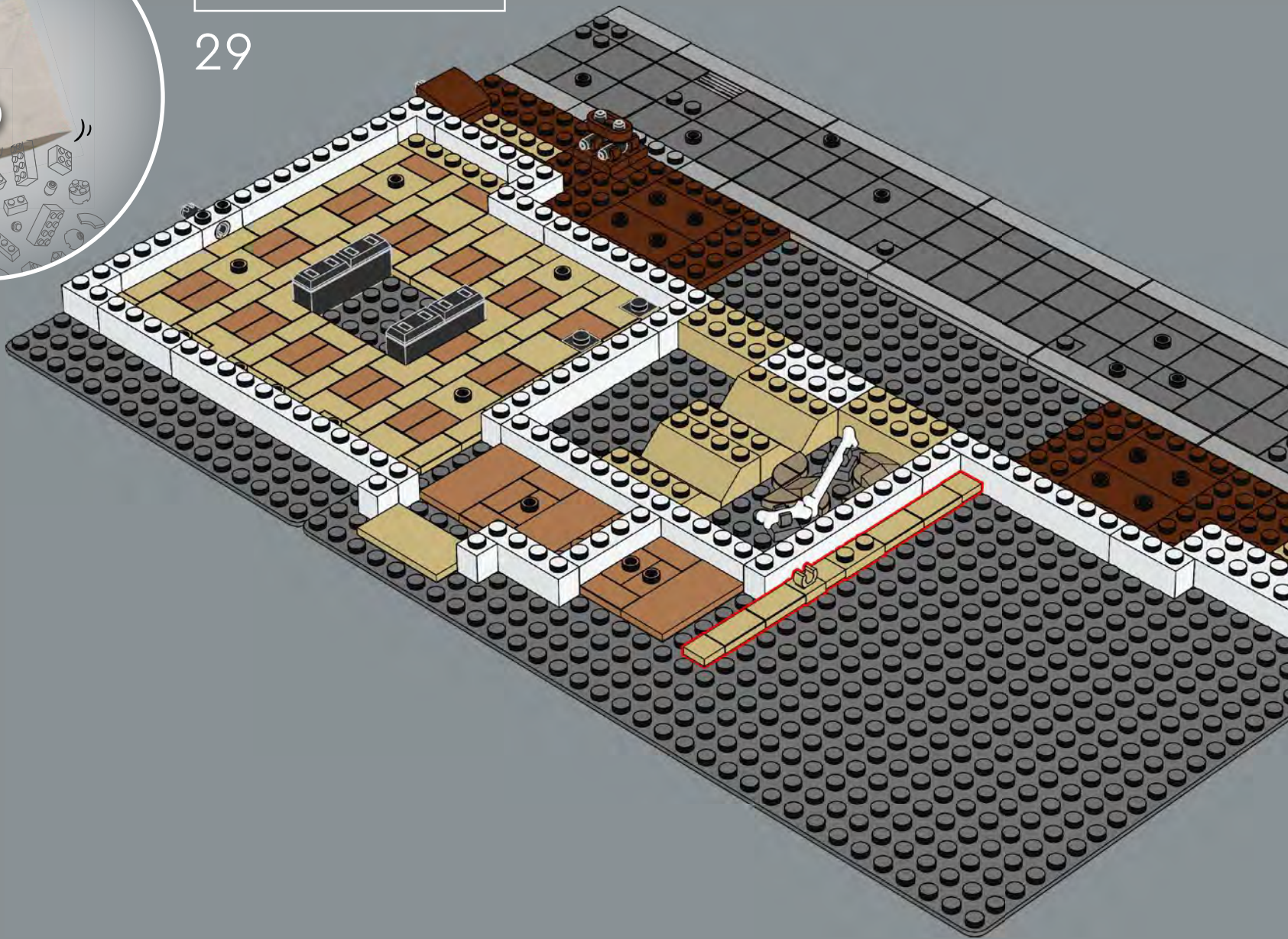

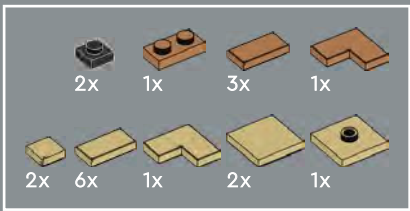

30



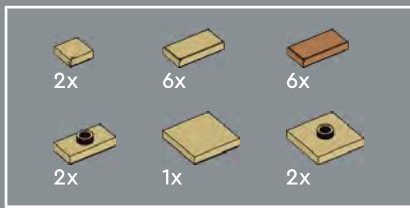

31

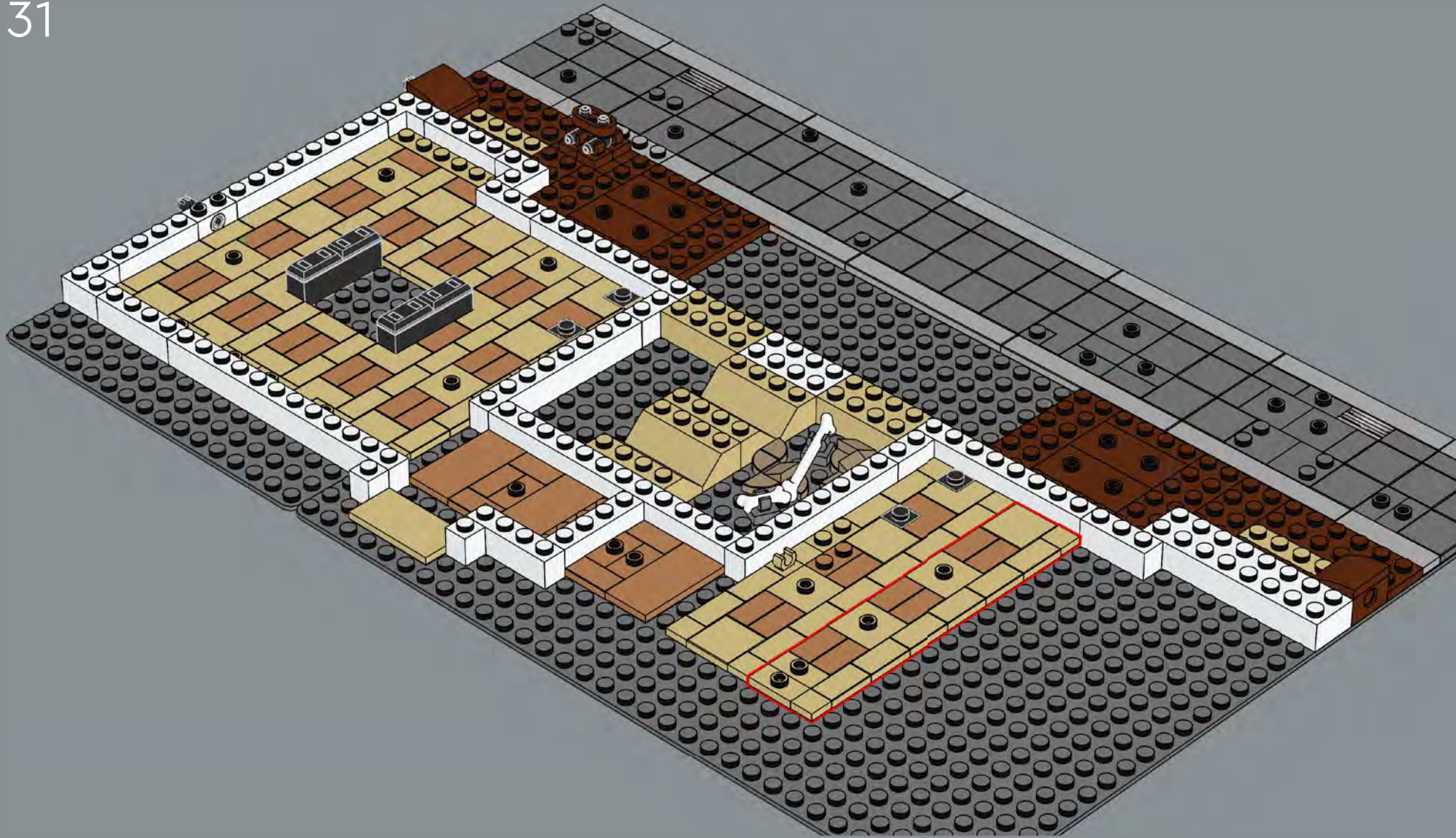

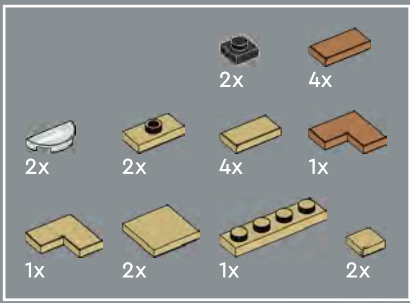

32



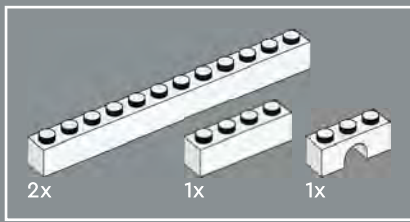

33

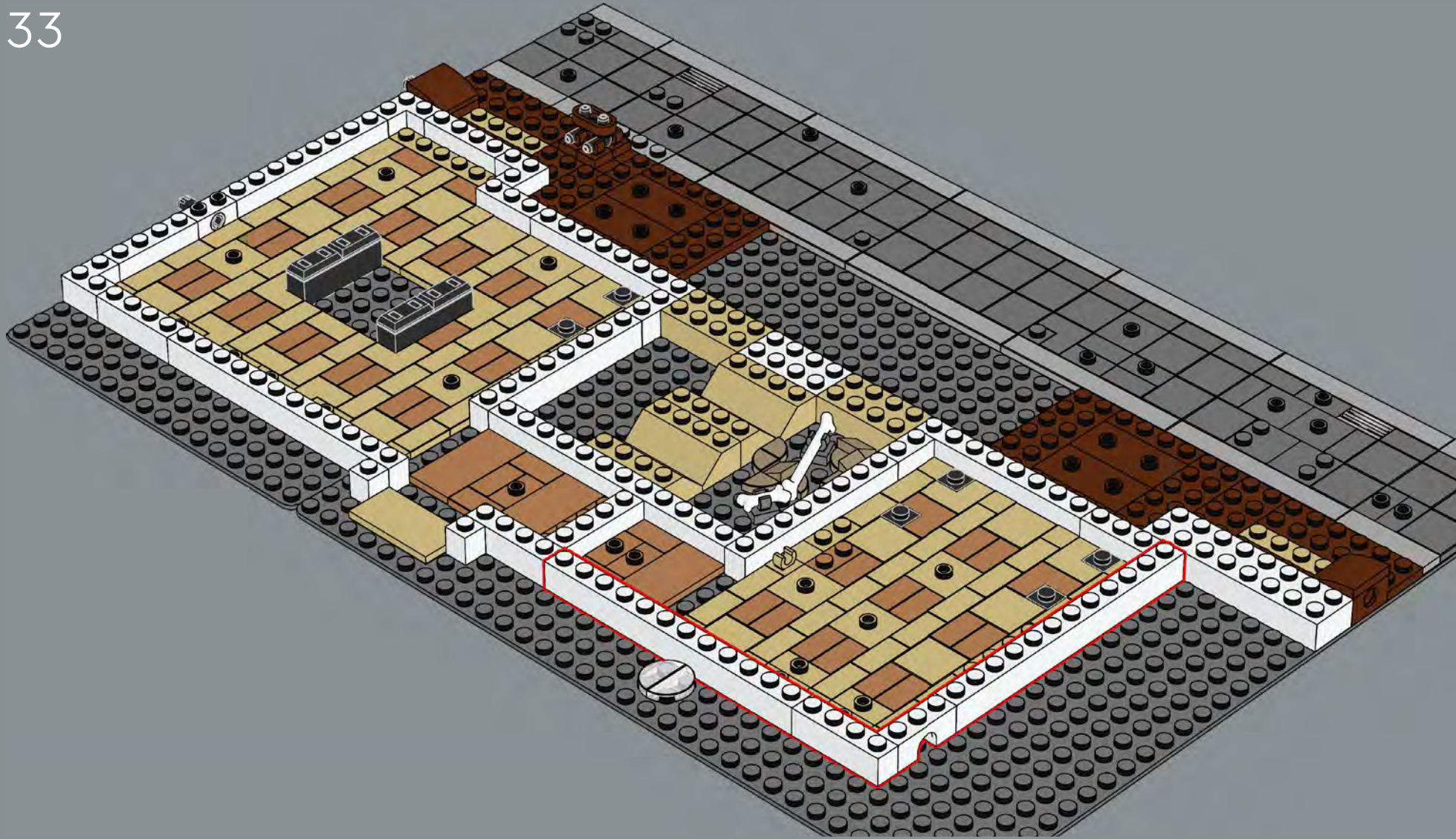

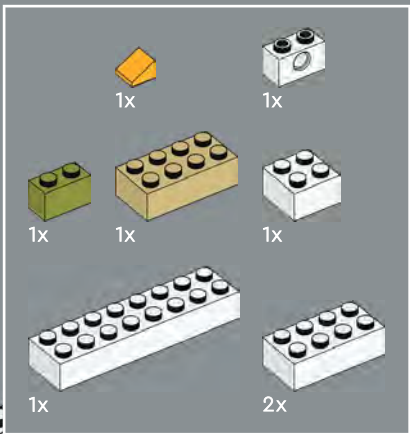

34





35

1



2



3

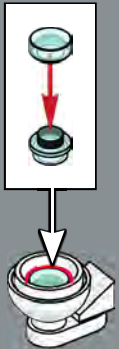

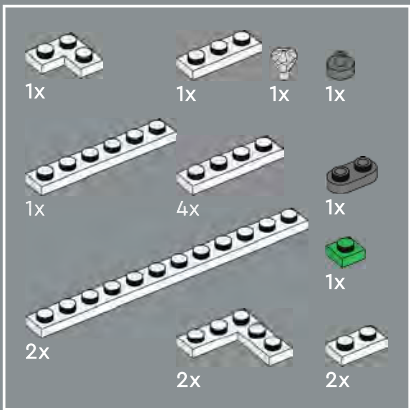

36

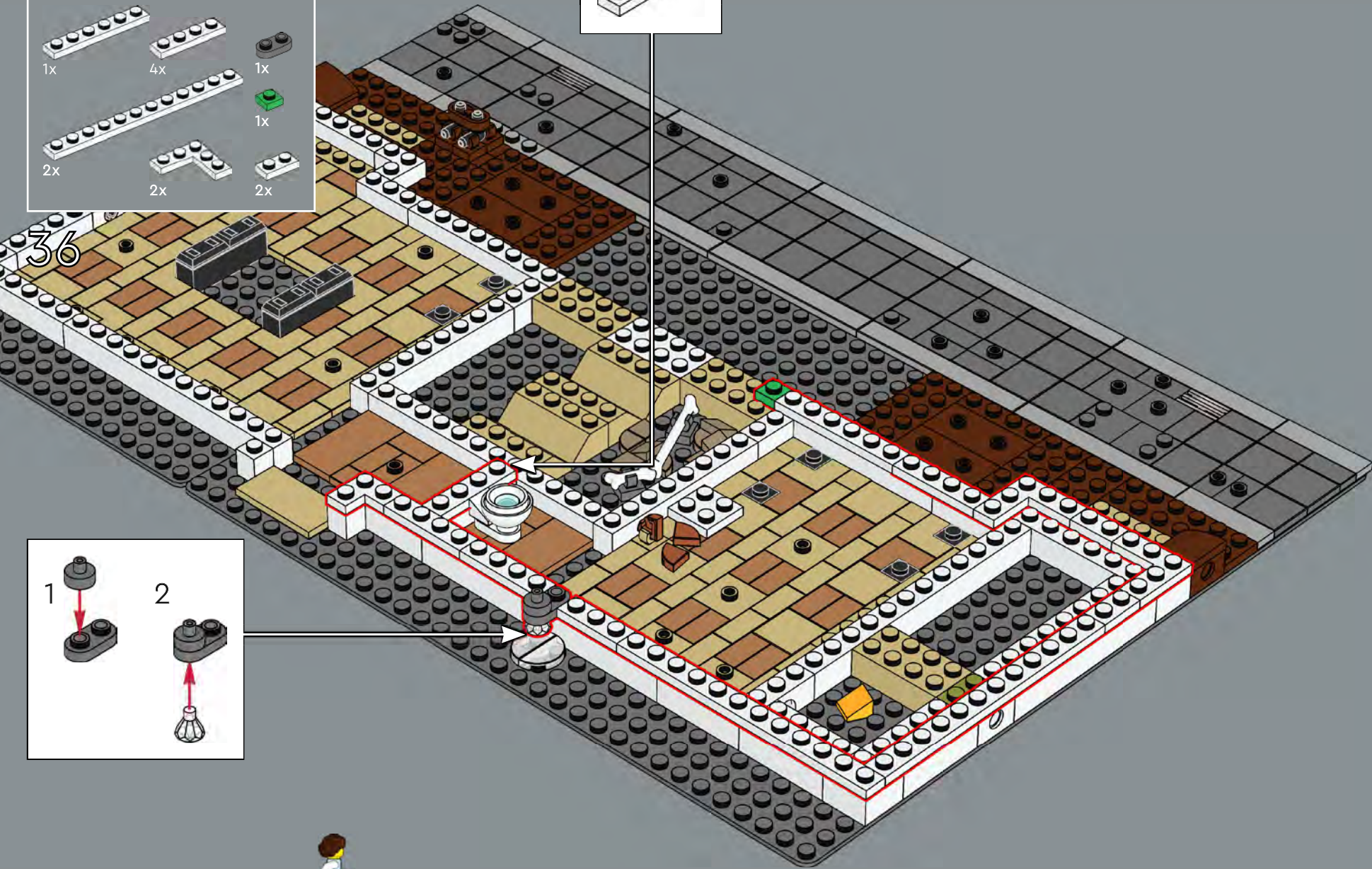
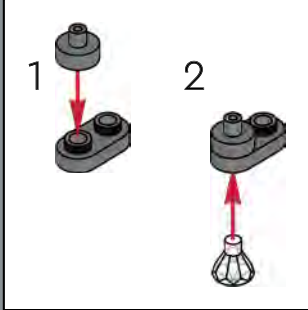
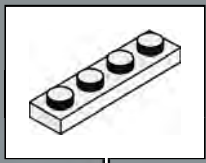

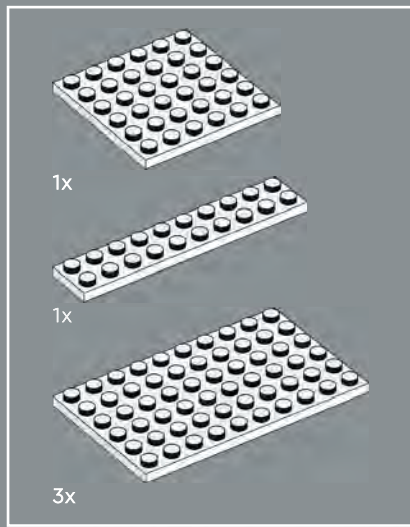

37

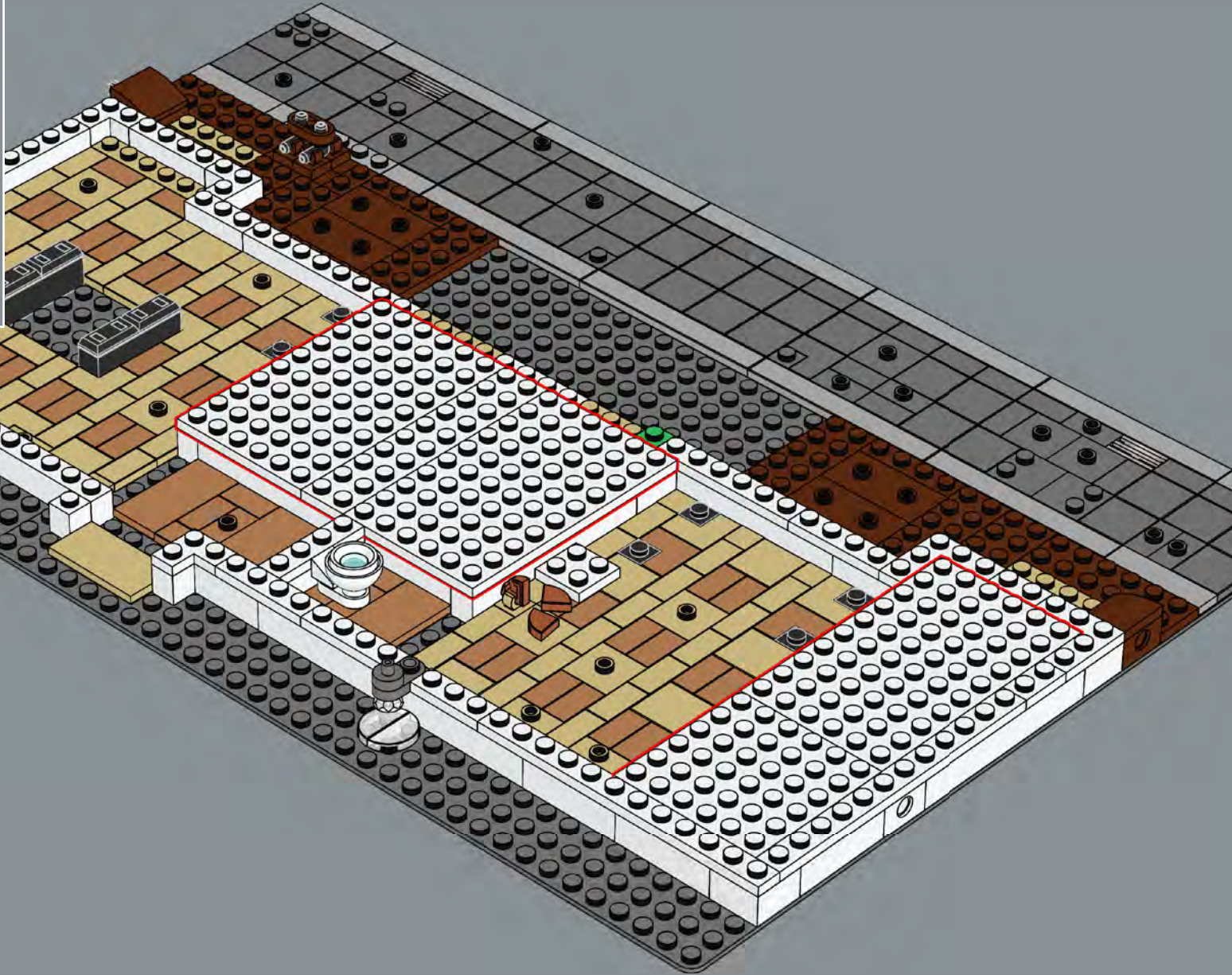

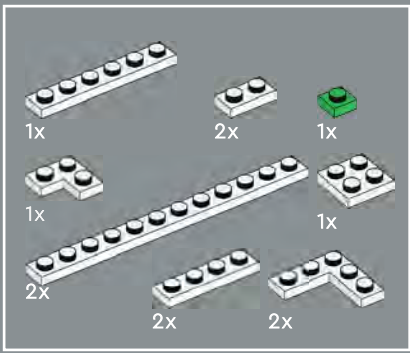

38

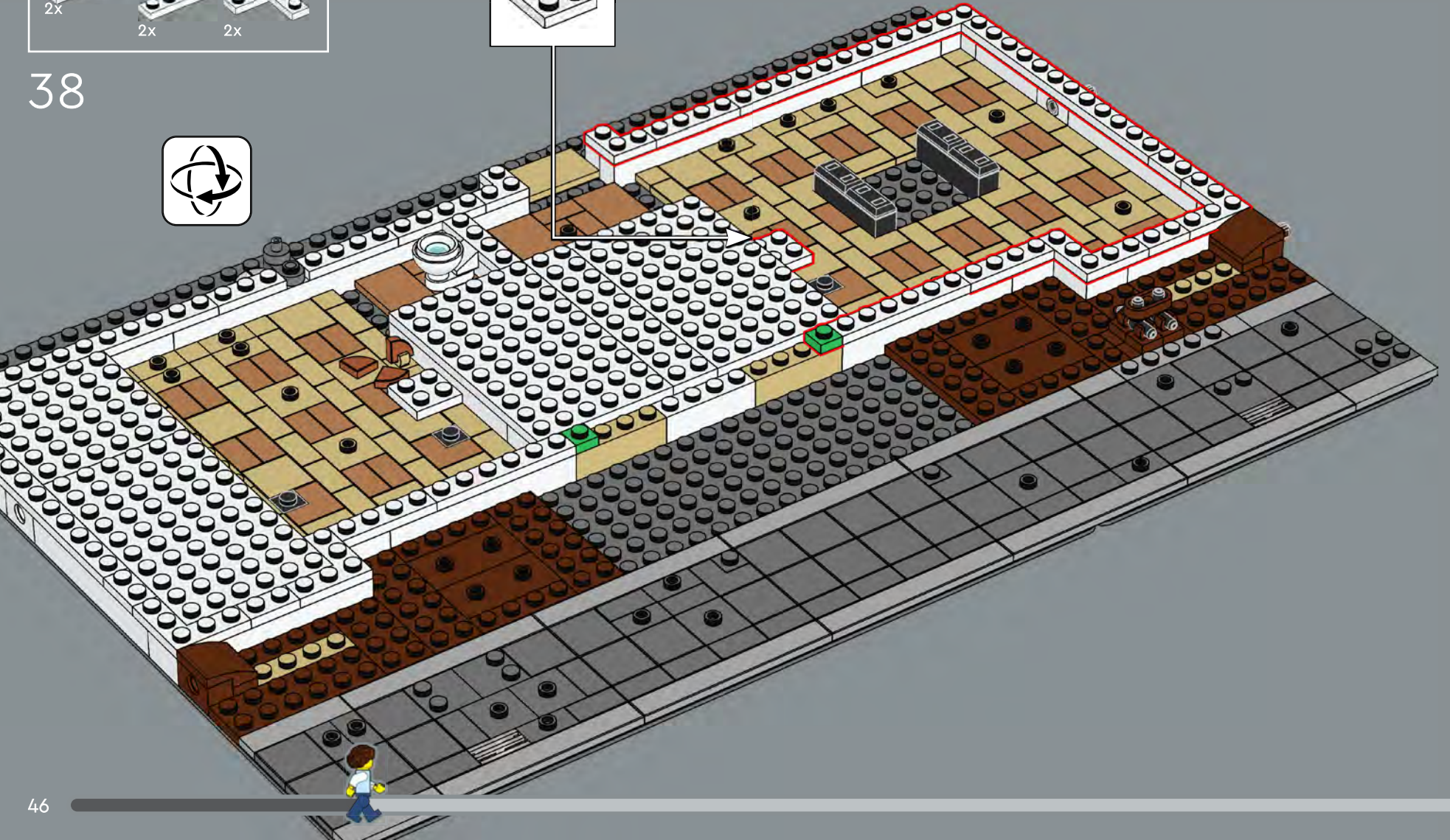
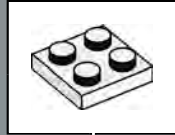

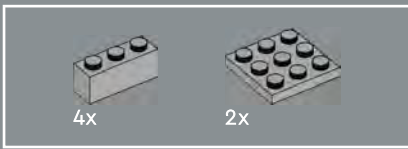

39

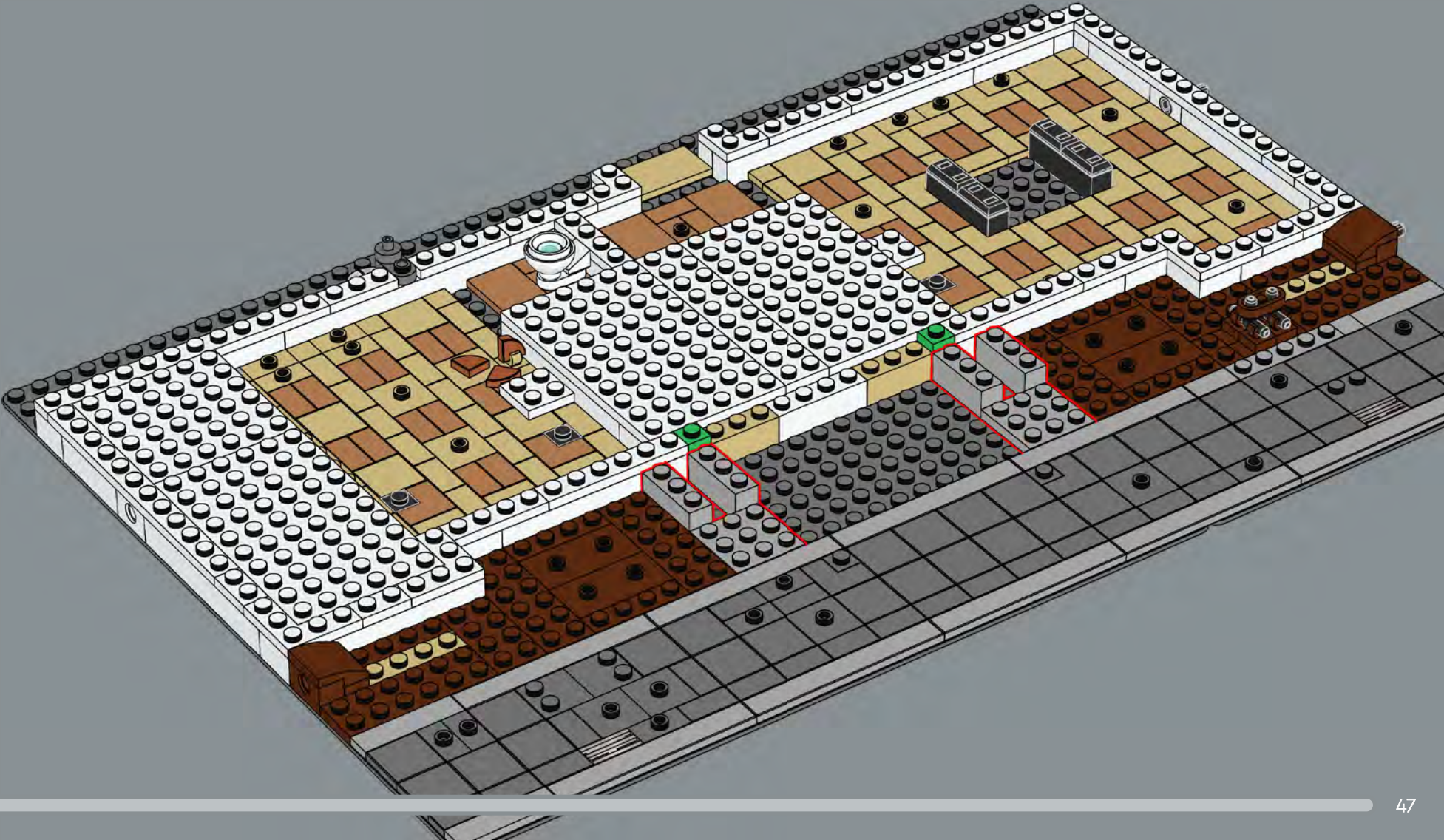

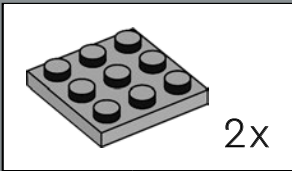

40

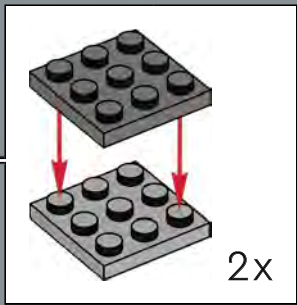
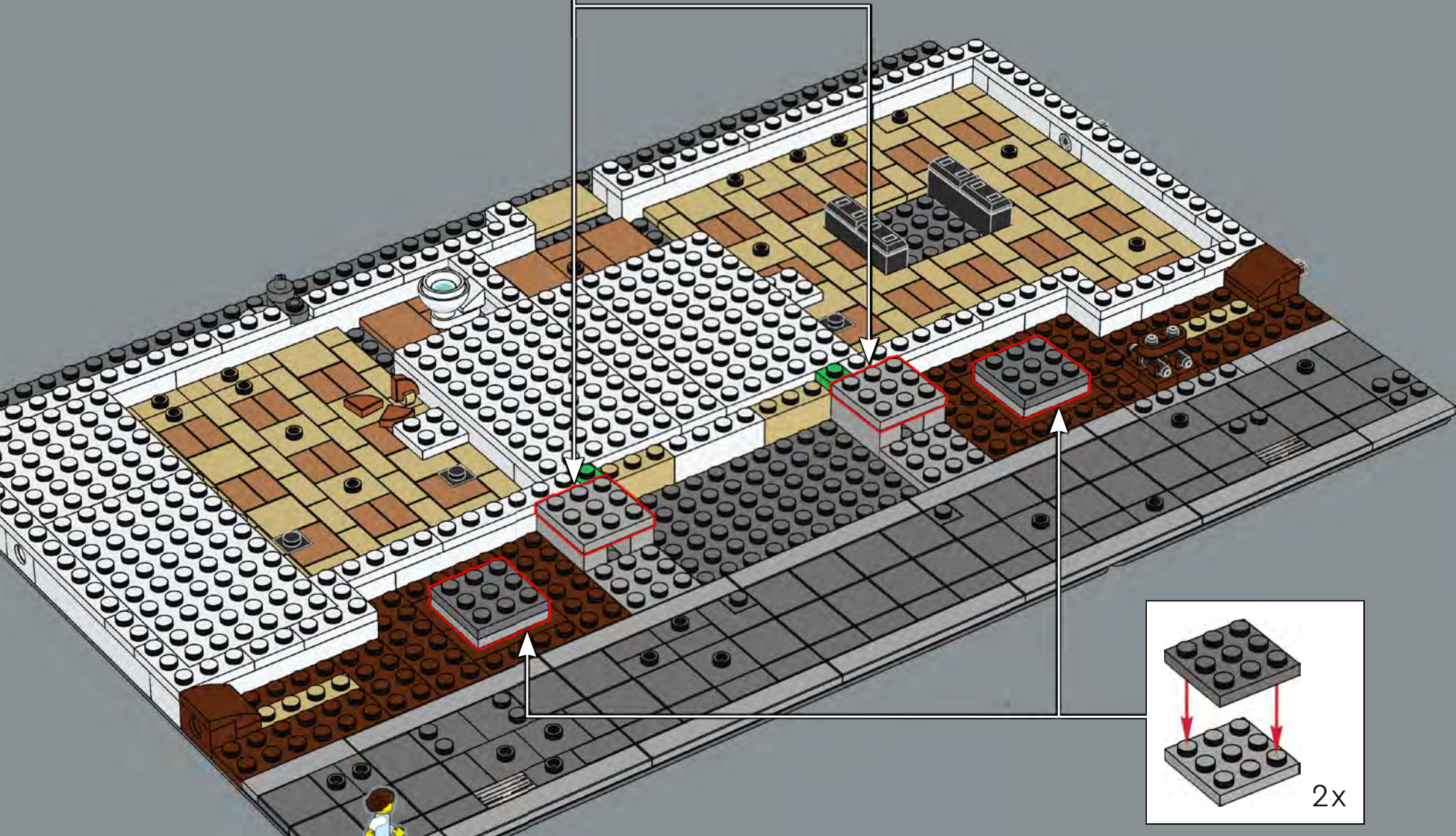

16x  8x 

41



8x

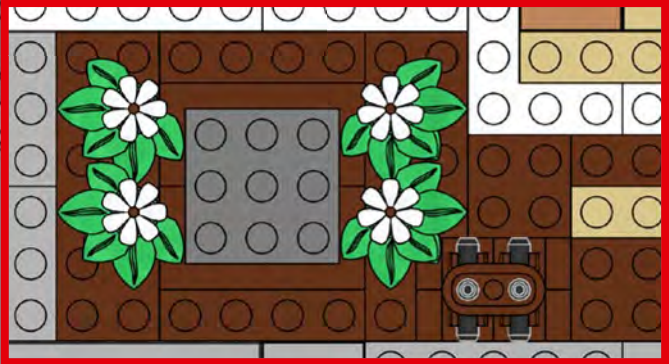

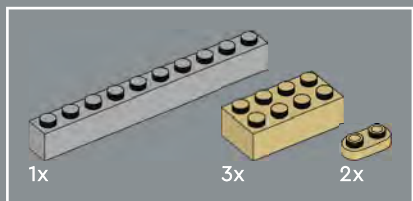

42



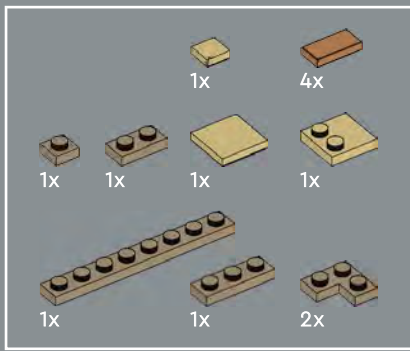

43





44



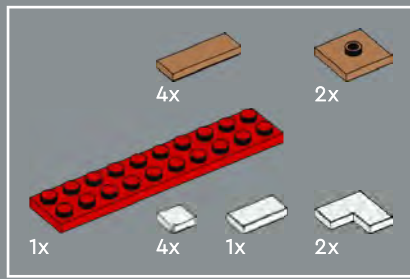

45



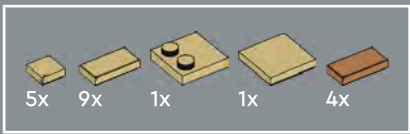

46

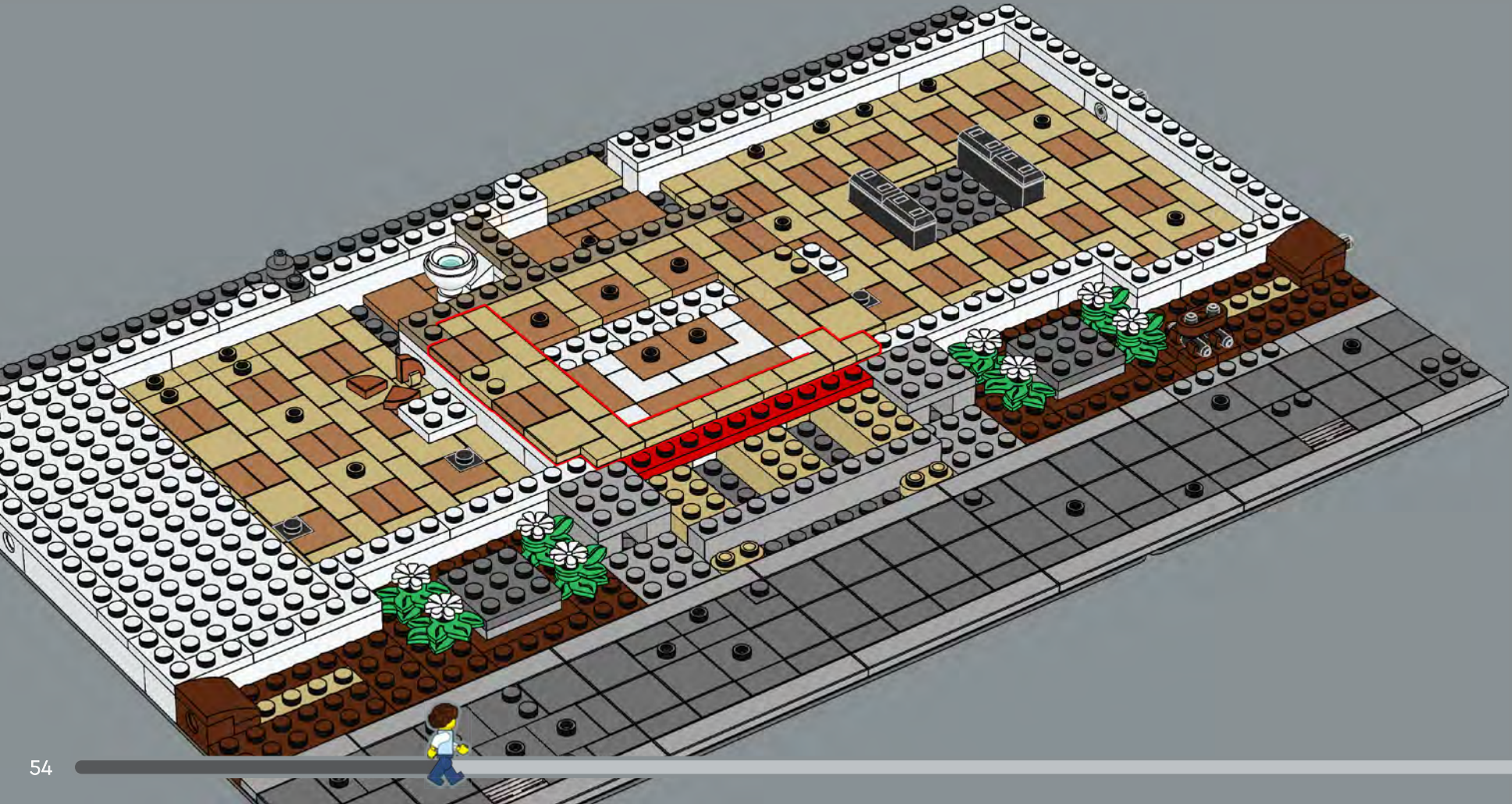

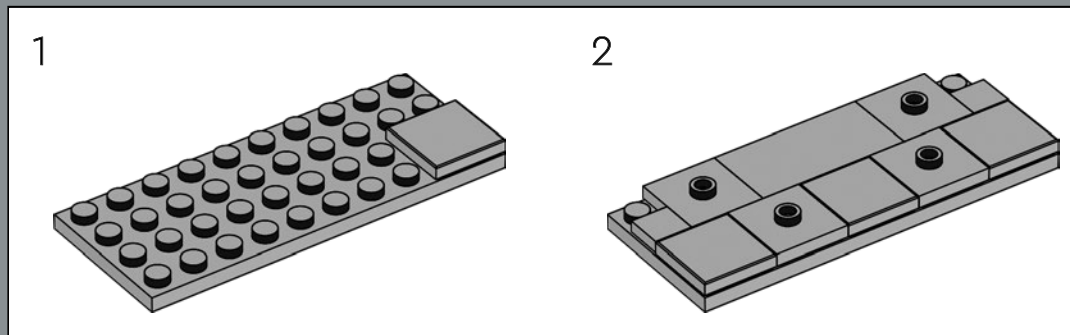
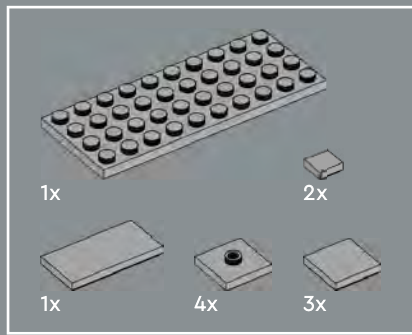

47

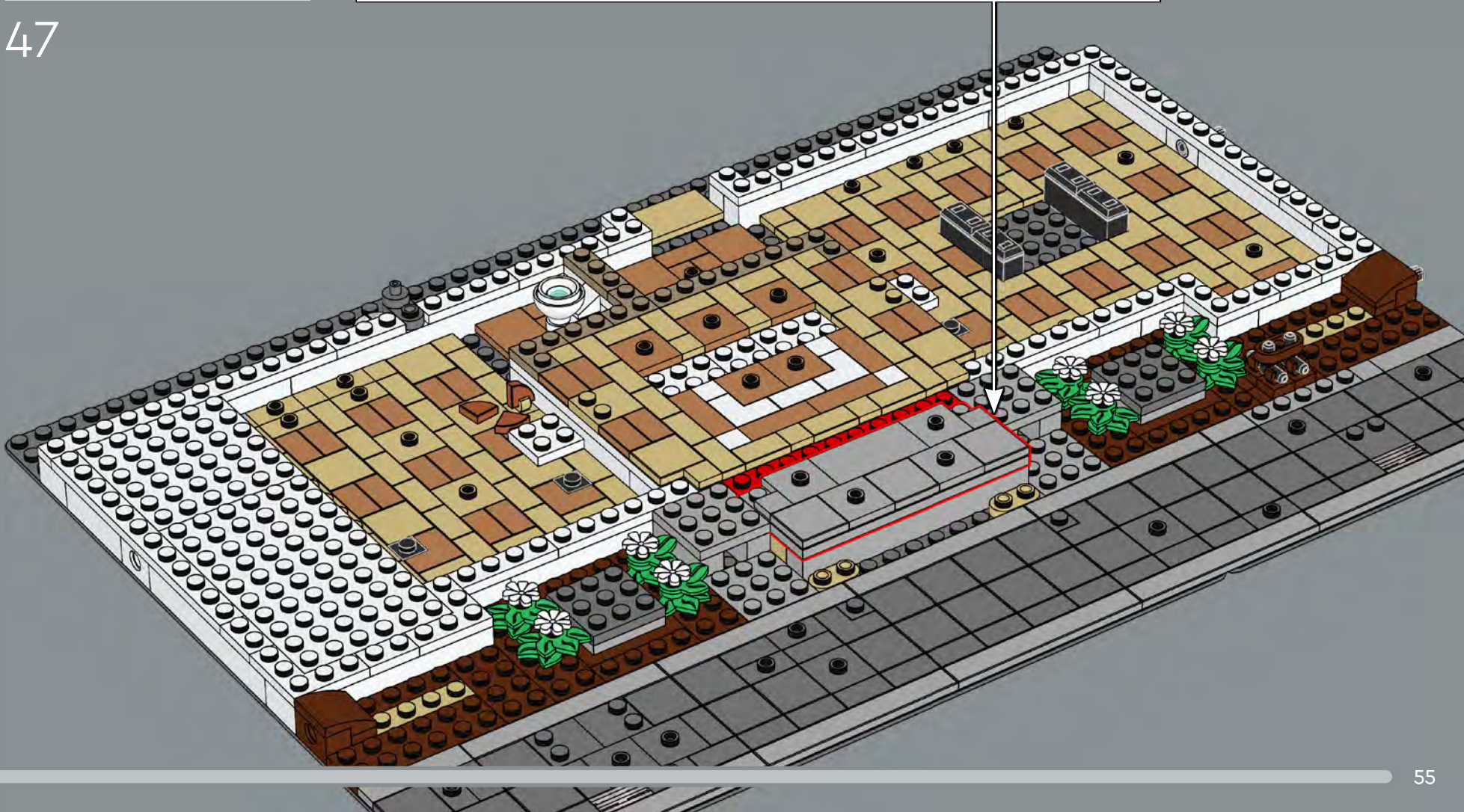

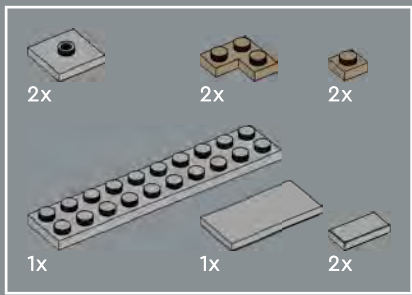

48

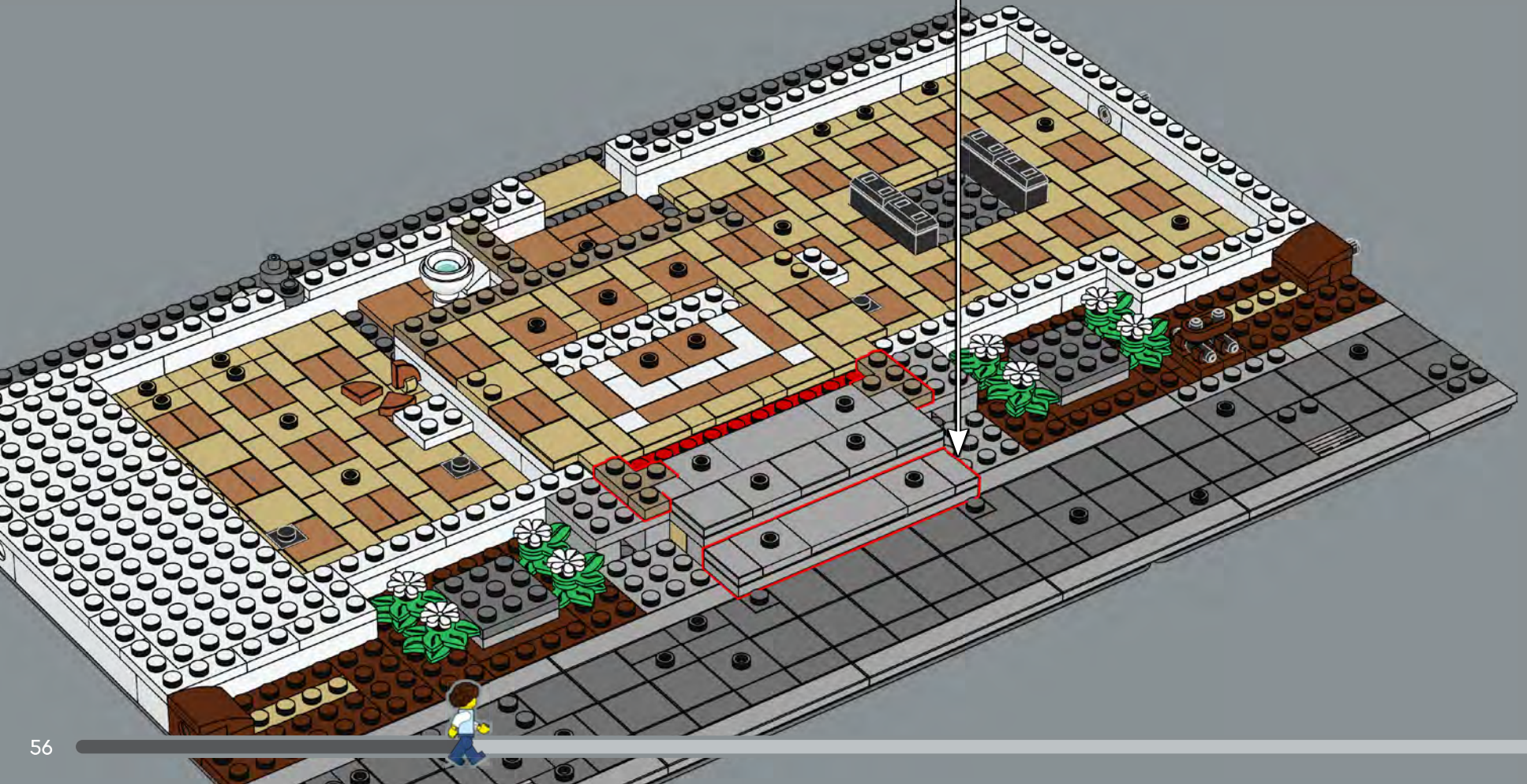
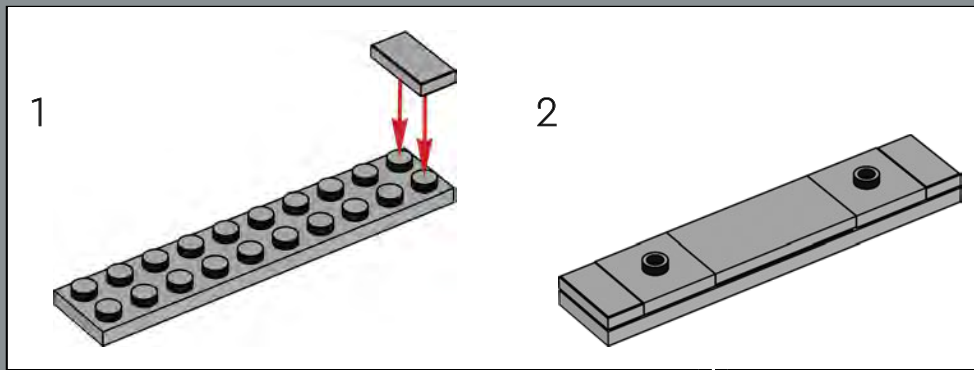

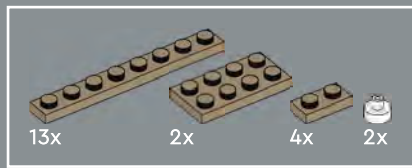

49

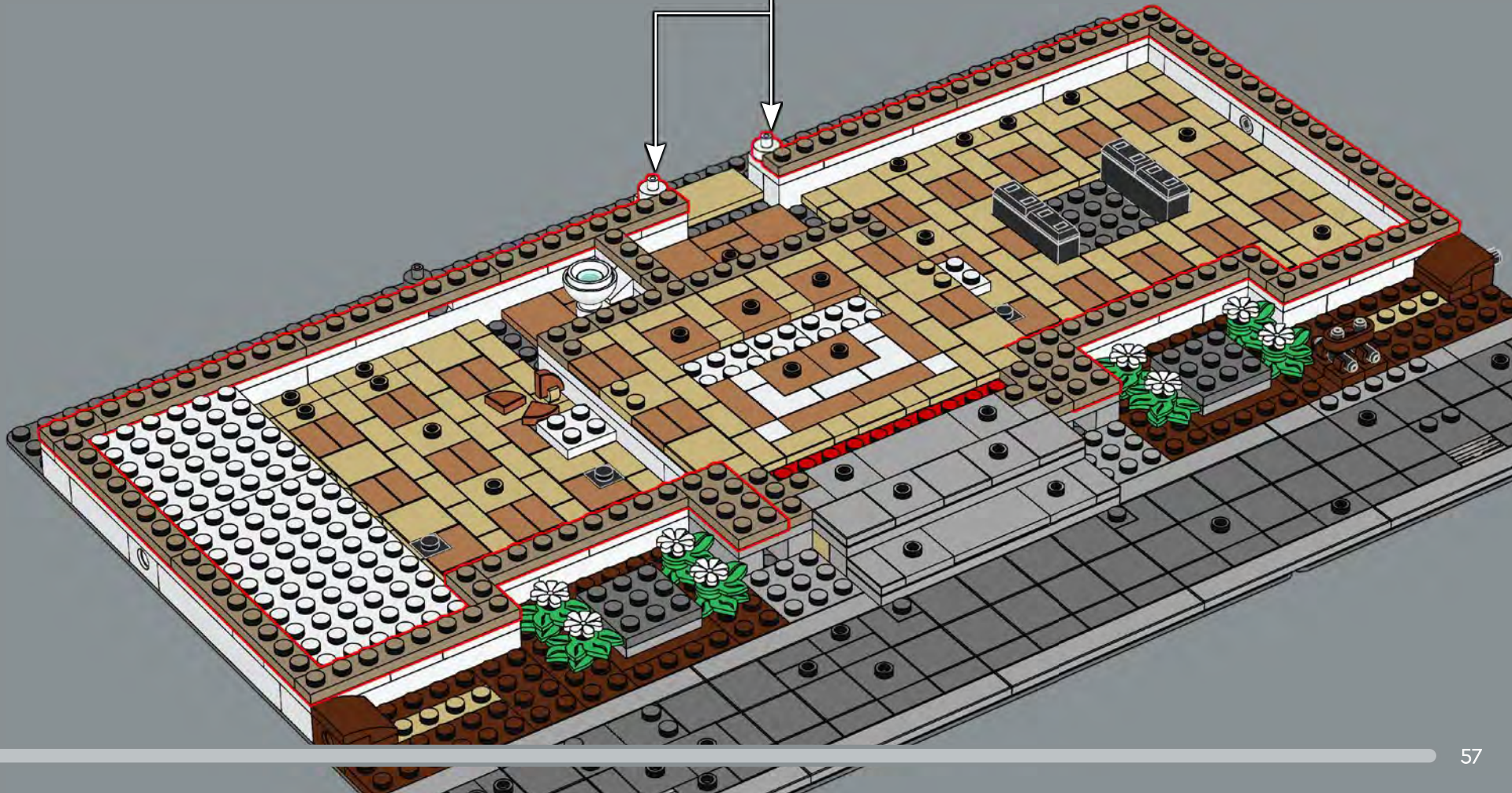
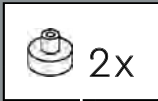

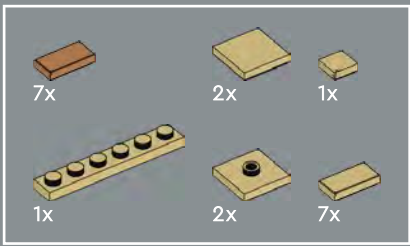

50



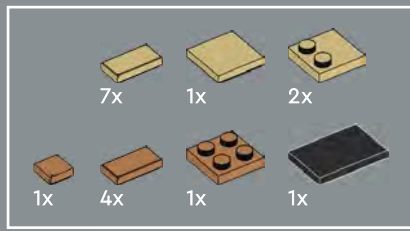

51

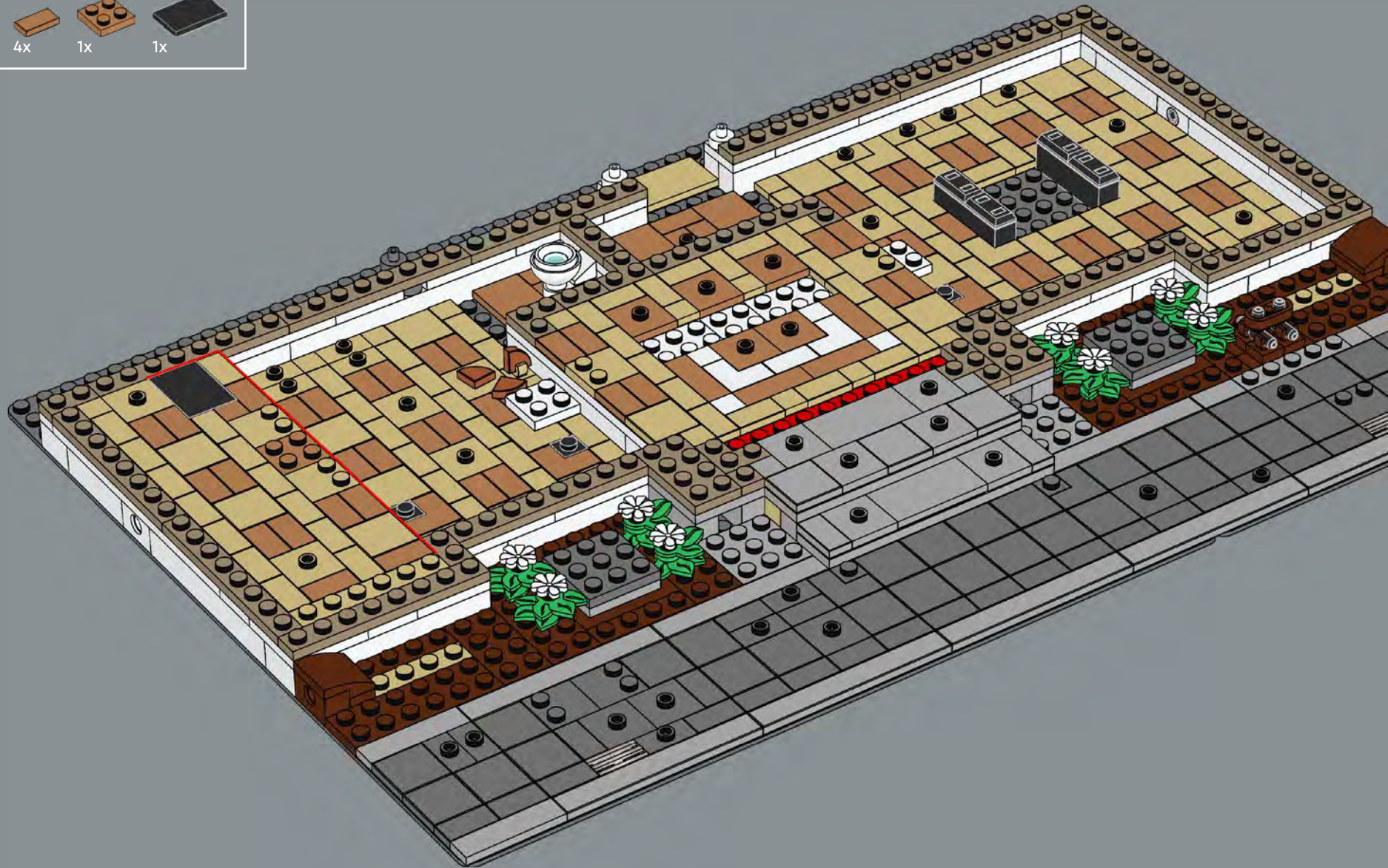

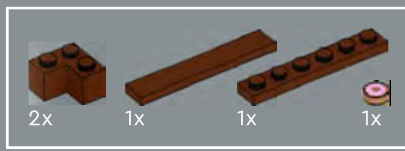

52

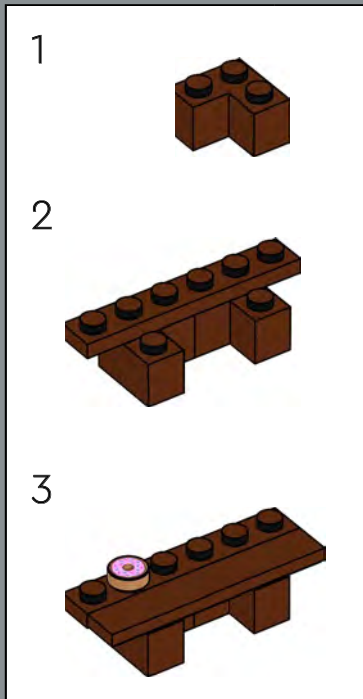
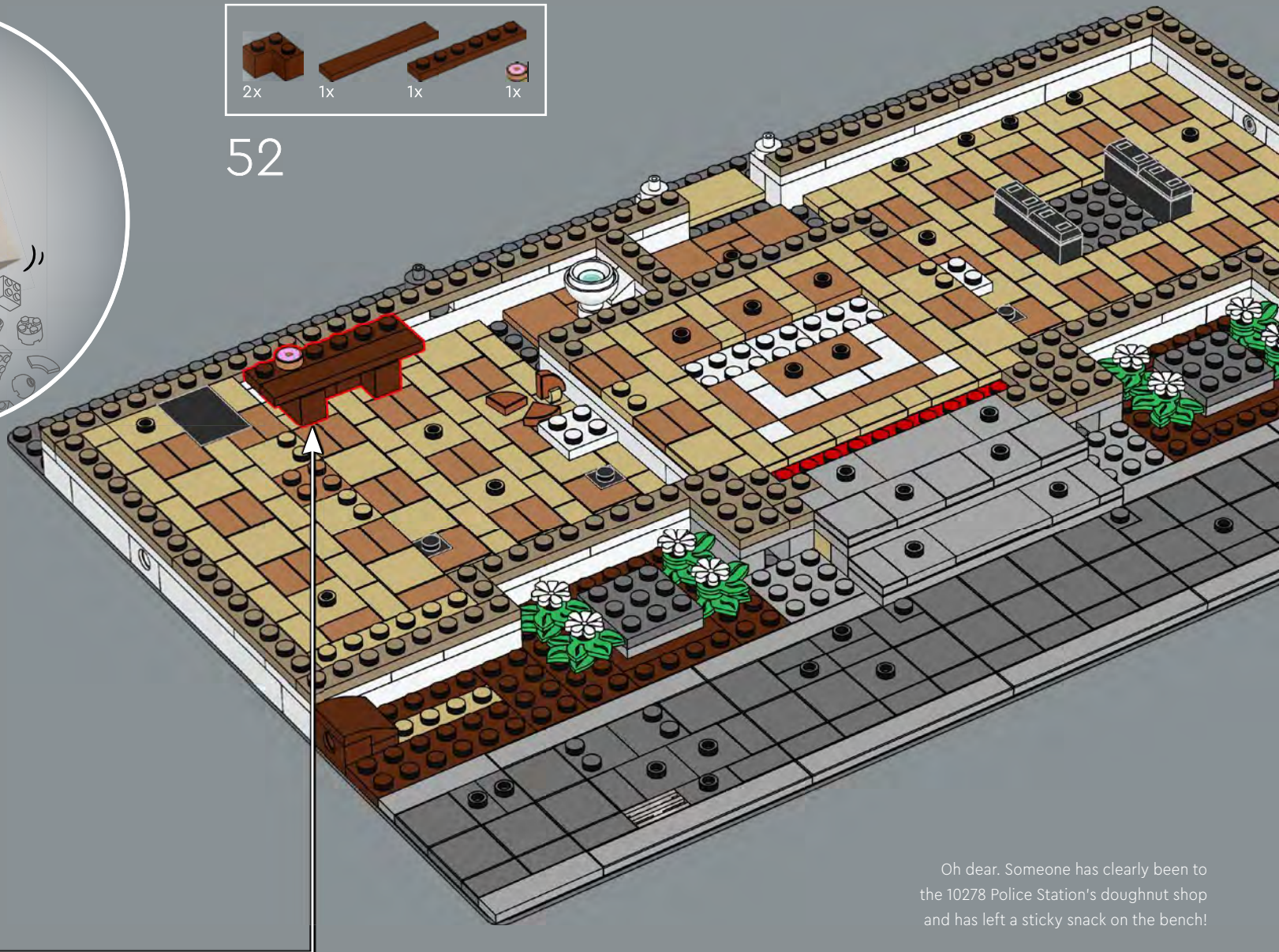

Oh dear. Someone has clearly been to the 10278 Police Station's doughnut shop and has left a sticky snack on the bench!



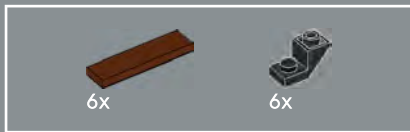

53

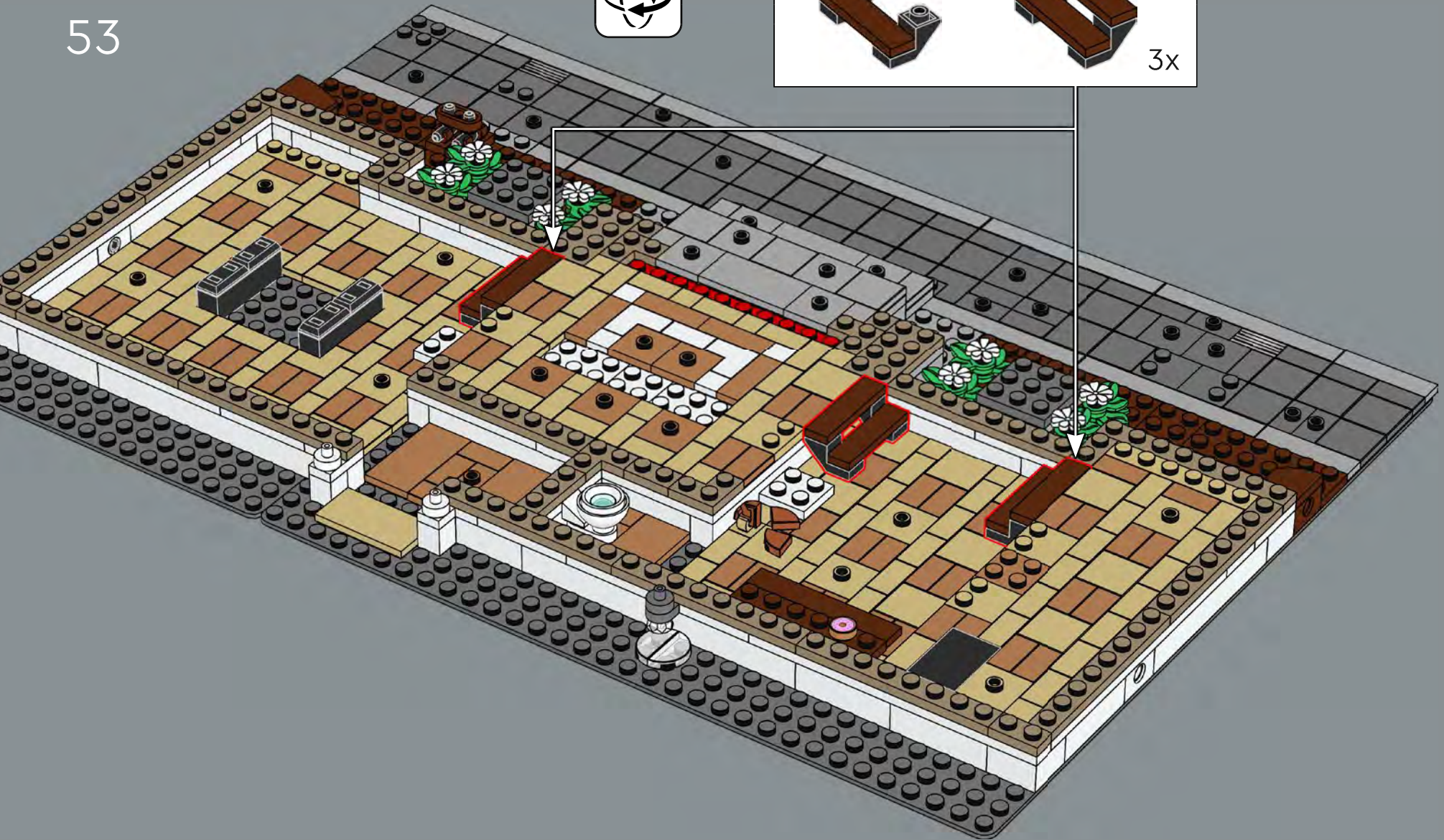
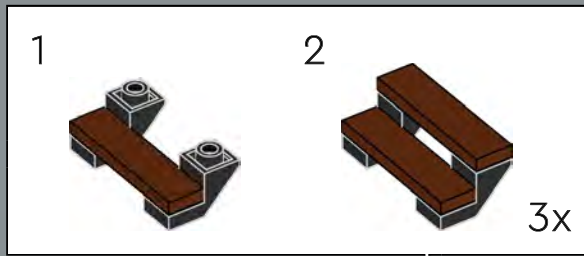

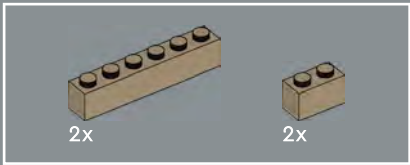

54

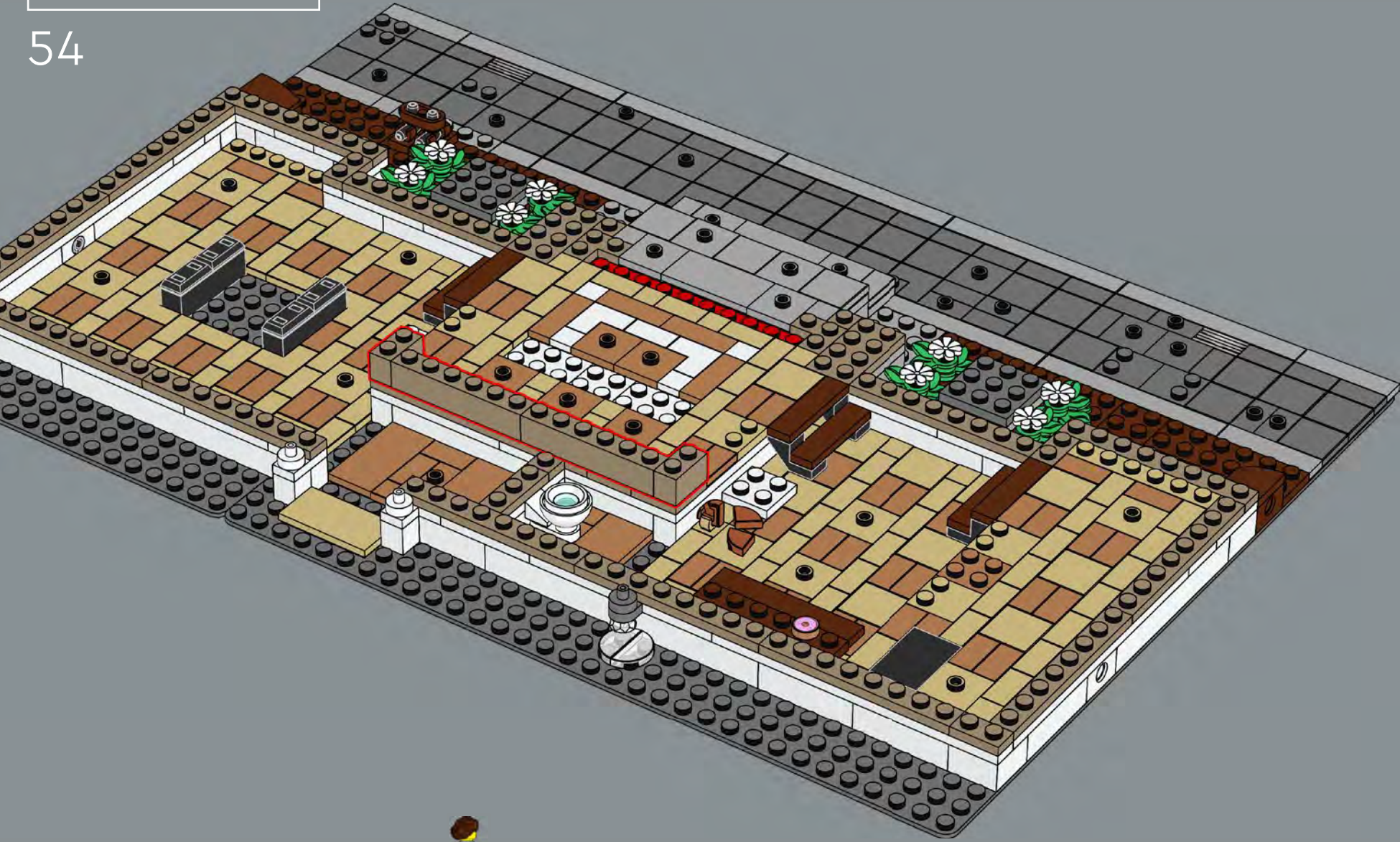

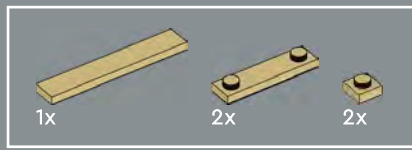

55

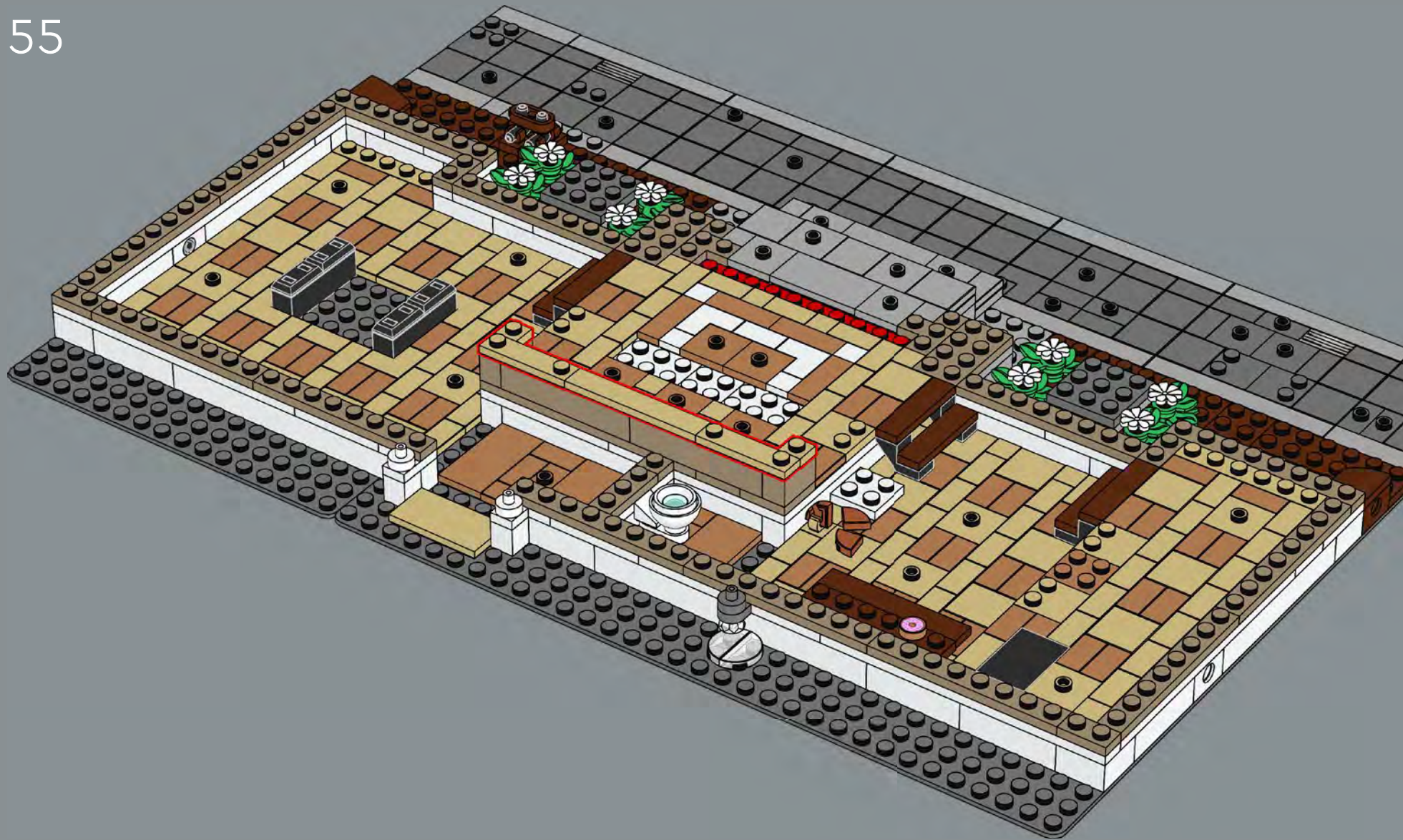

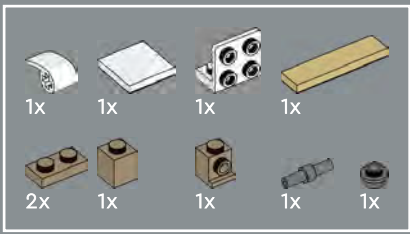

56

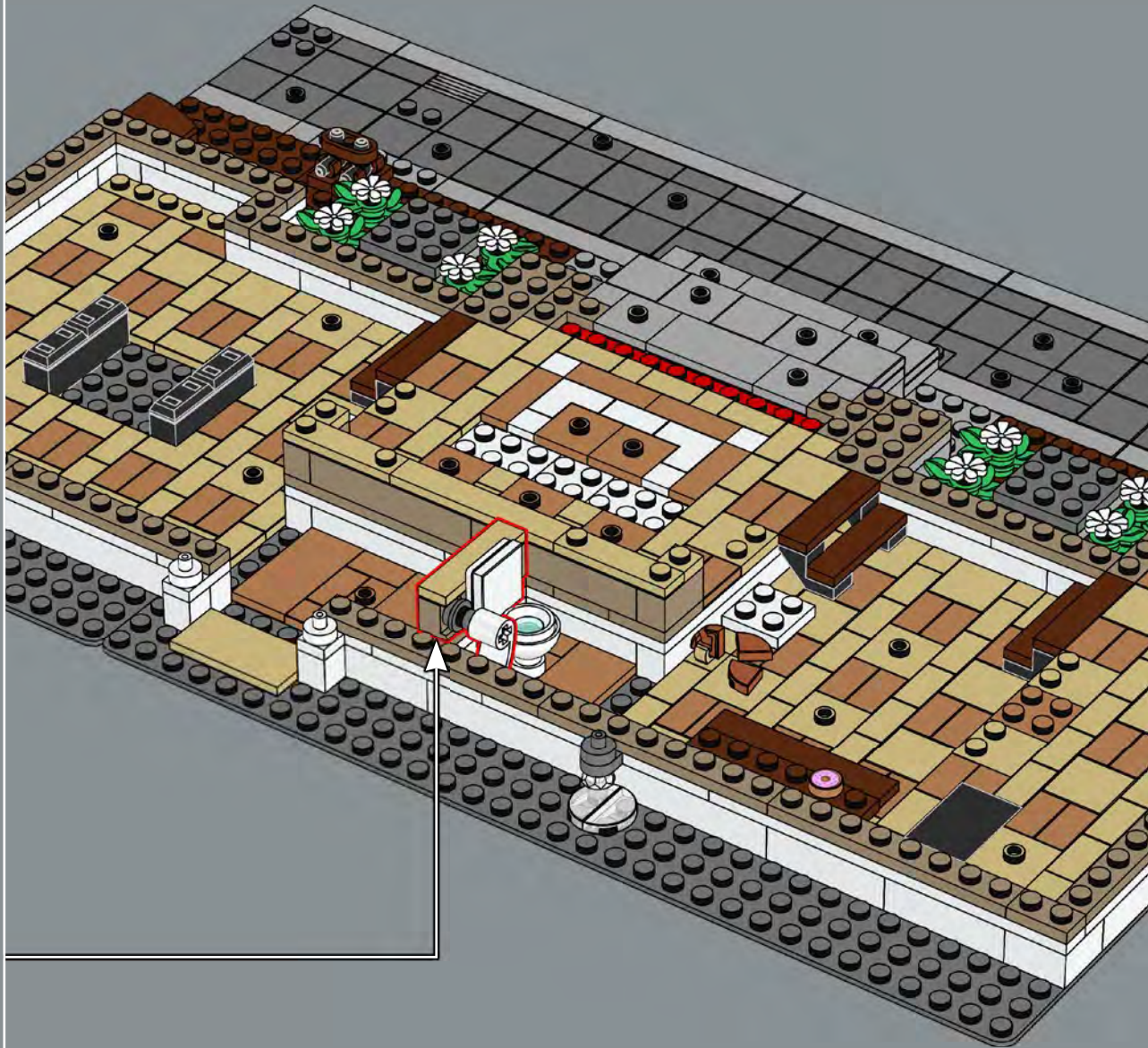
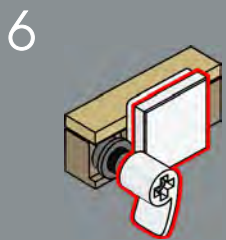
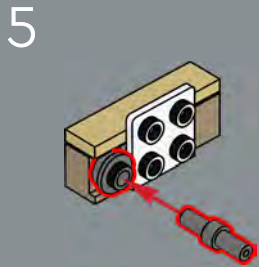
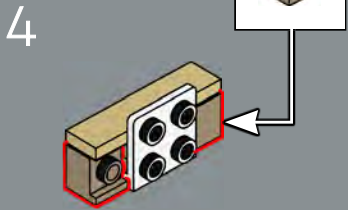
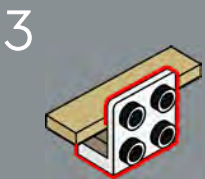
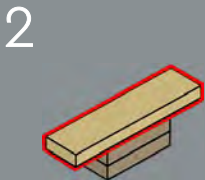
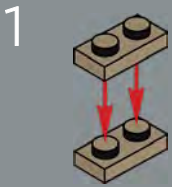

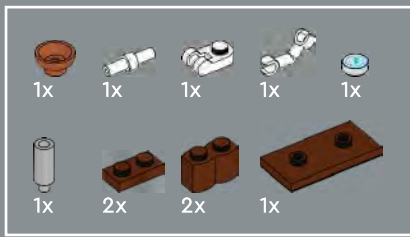

57

1



2

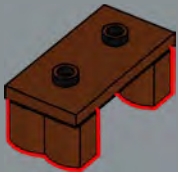

3

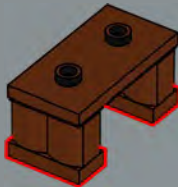

4



5

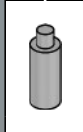
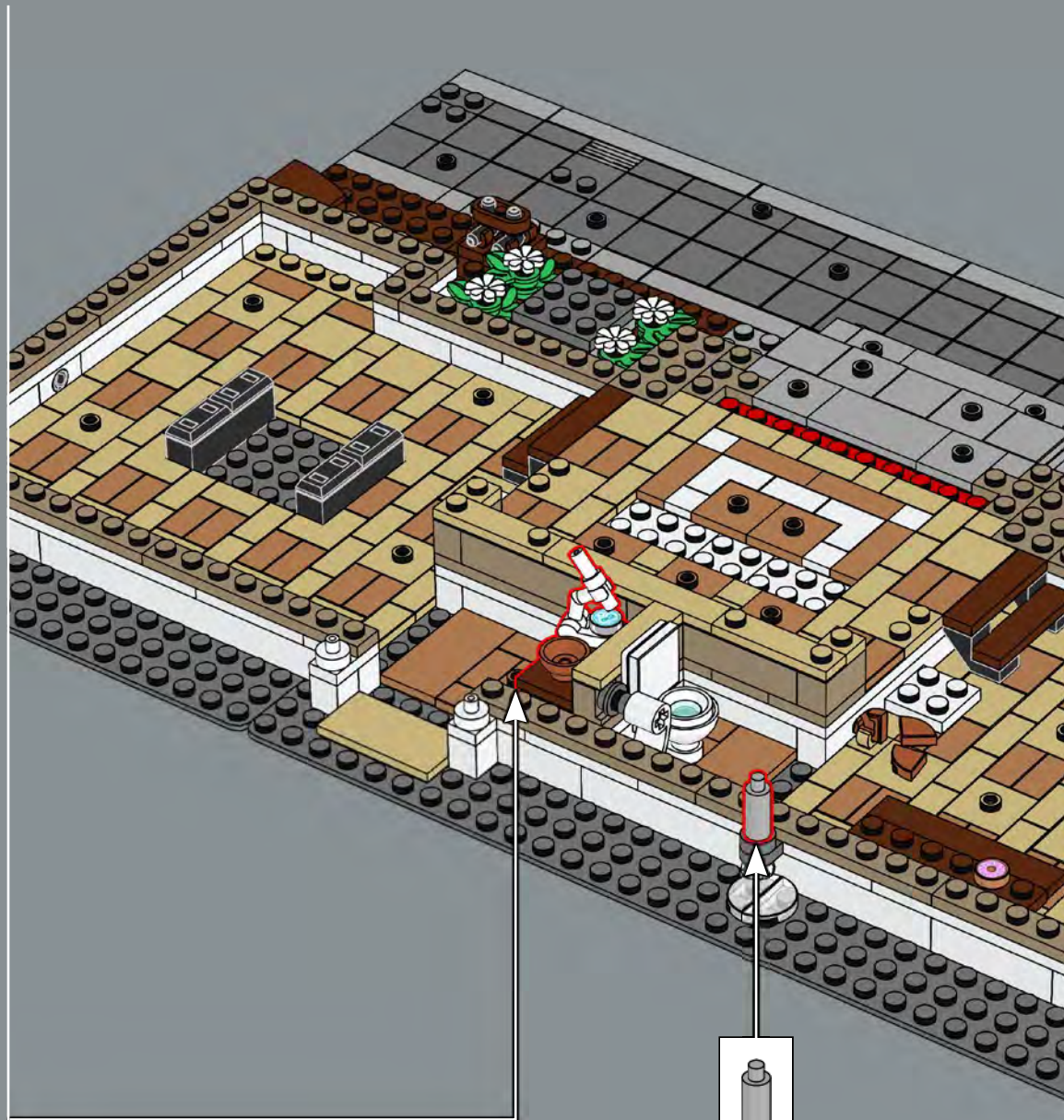

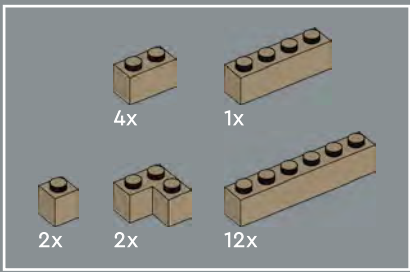

58

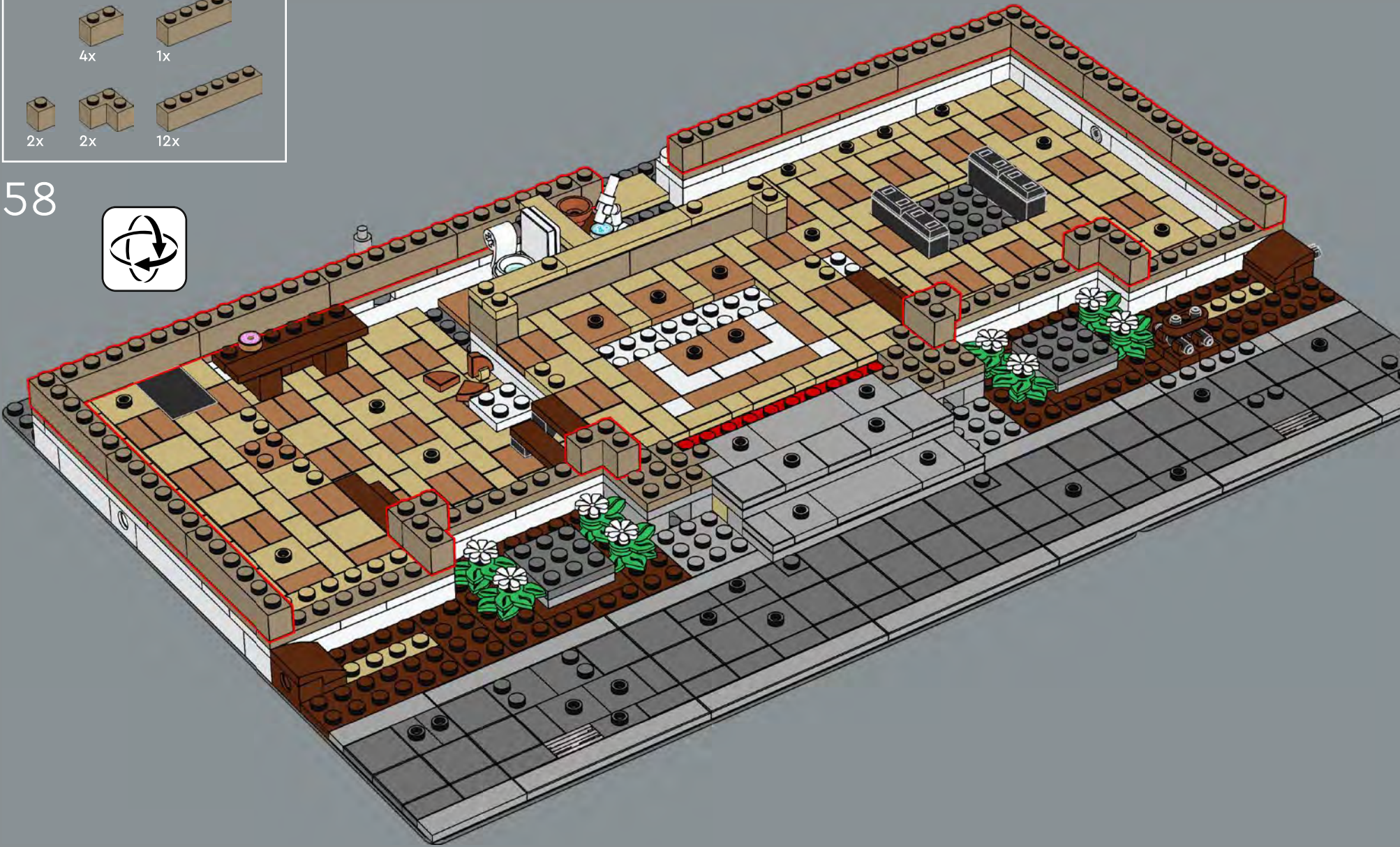

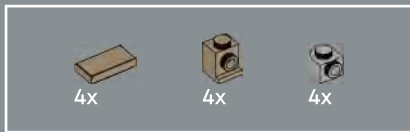

59

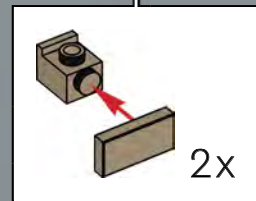
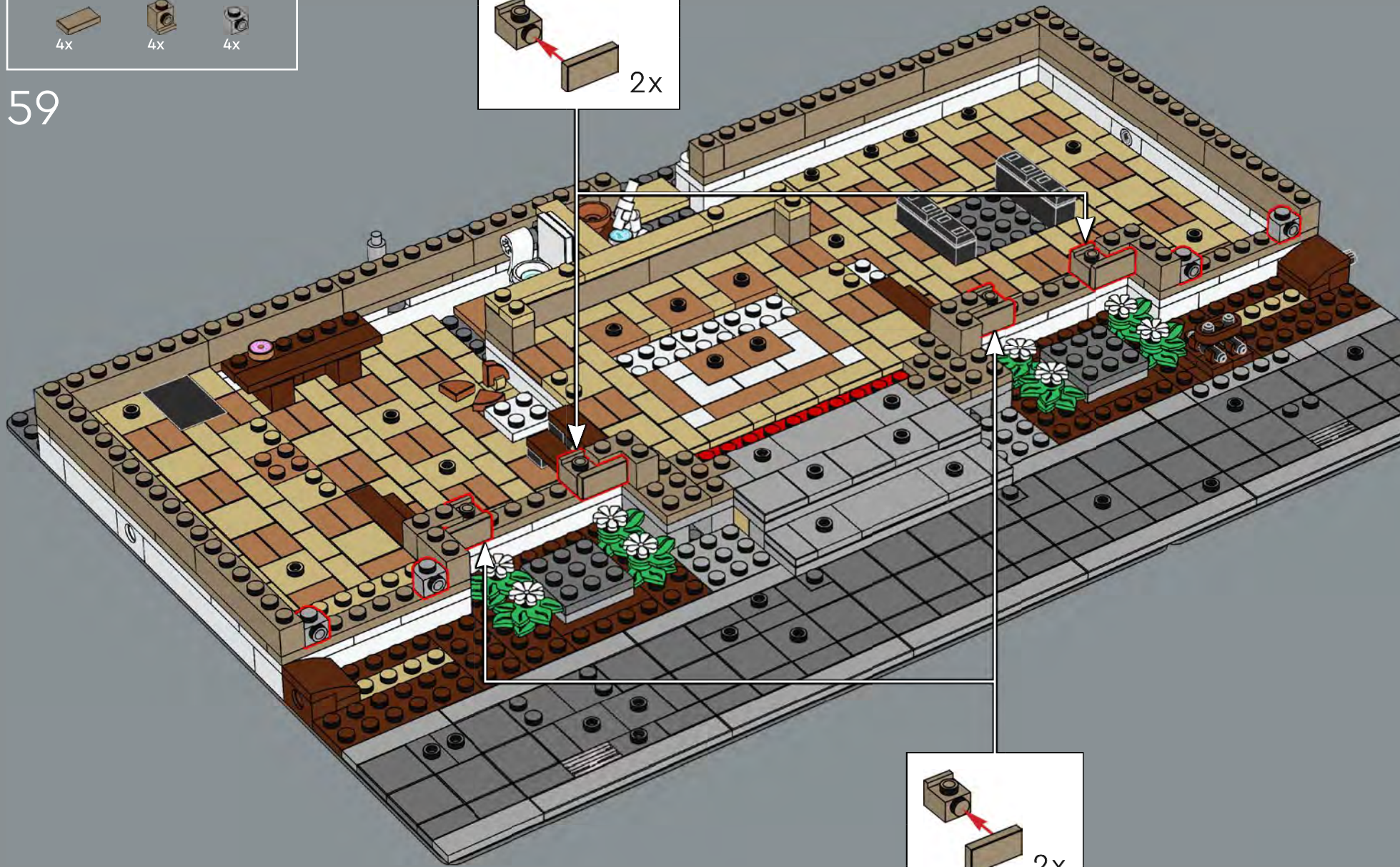
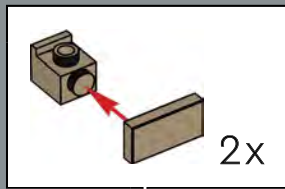

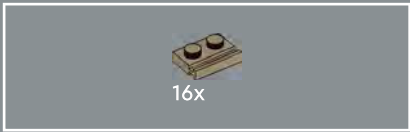

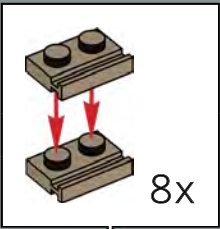

60

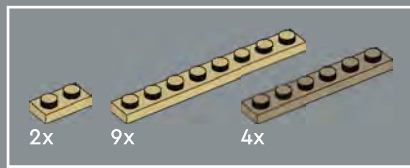



61



2x  6x 

62



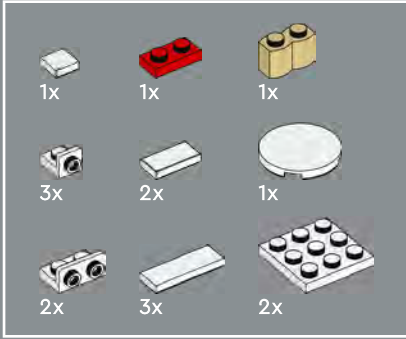
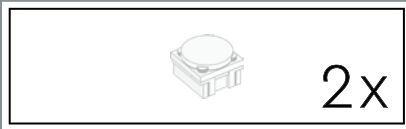

63

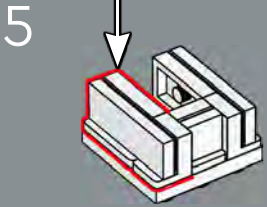
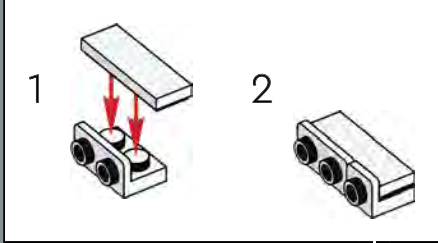
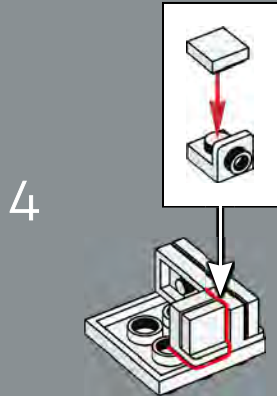
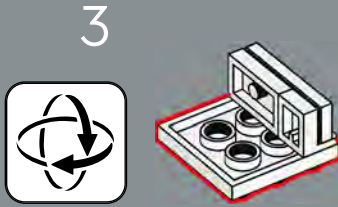
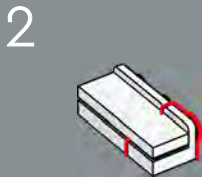
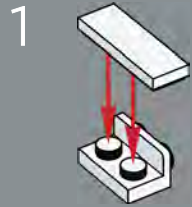

64

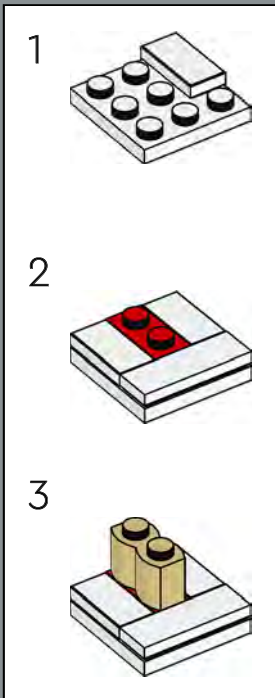

7

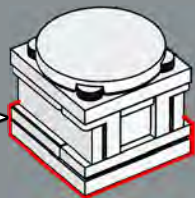

2x

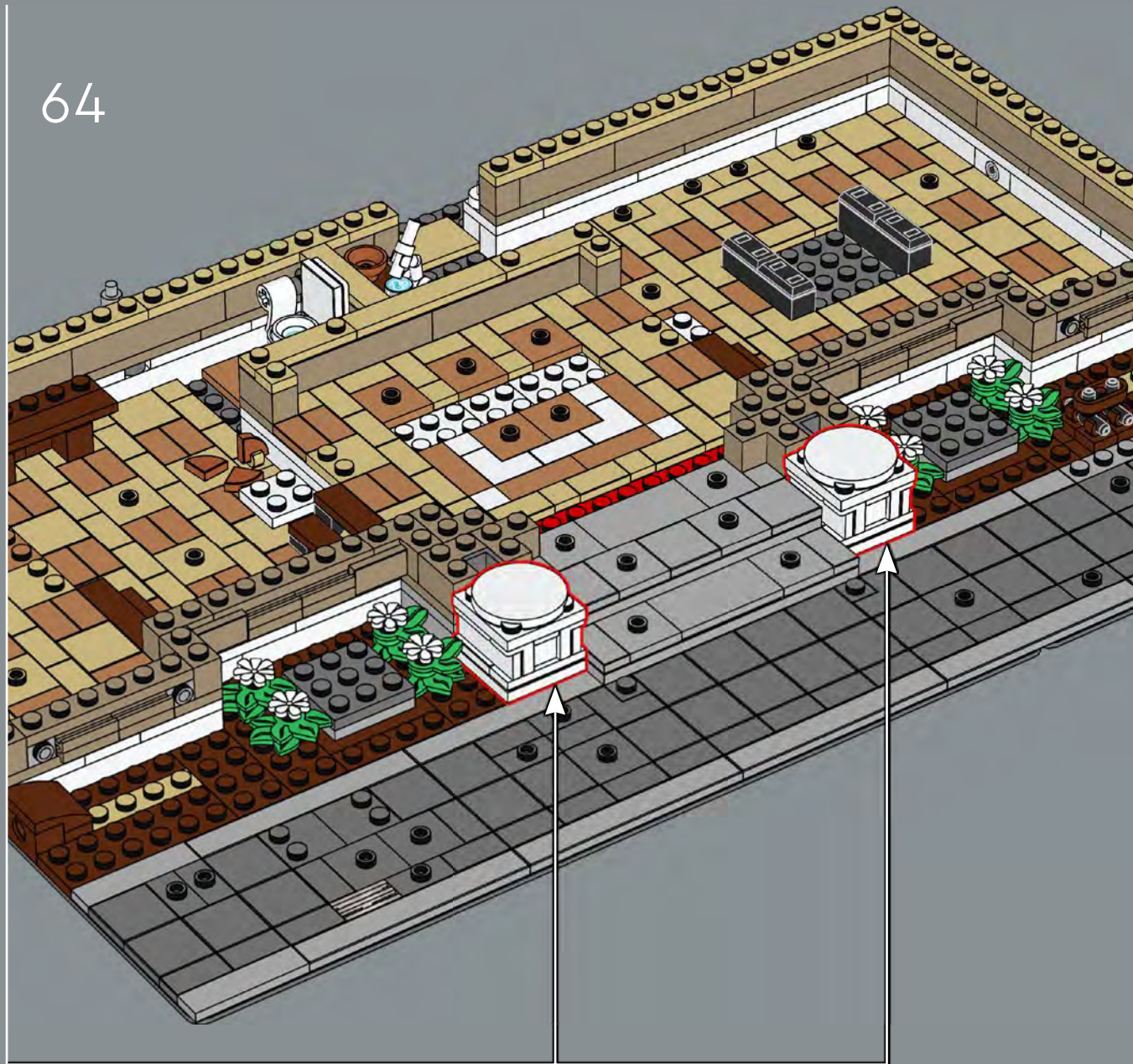

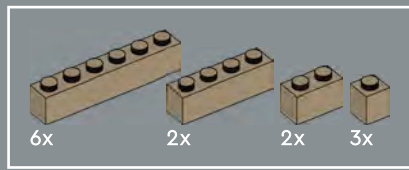

65

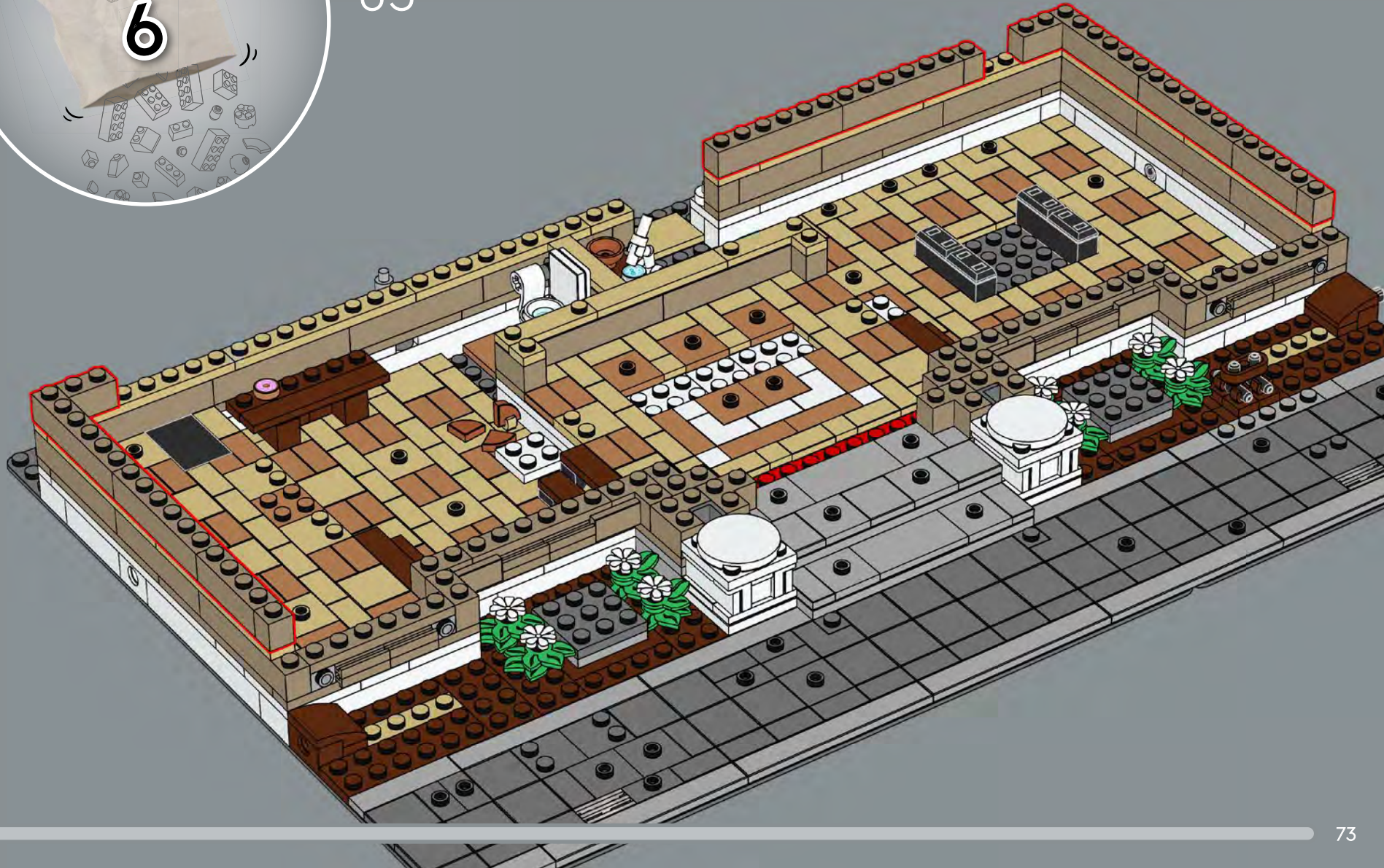

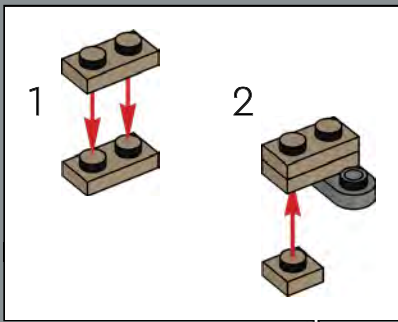
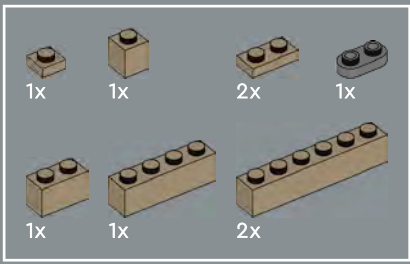

66



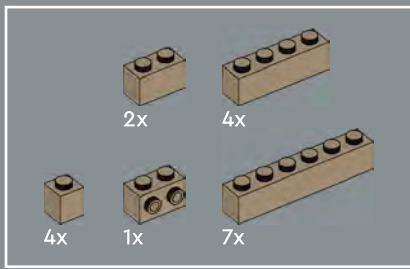

67

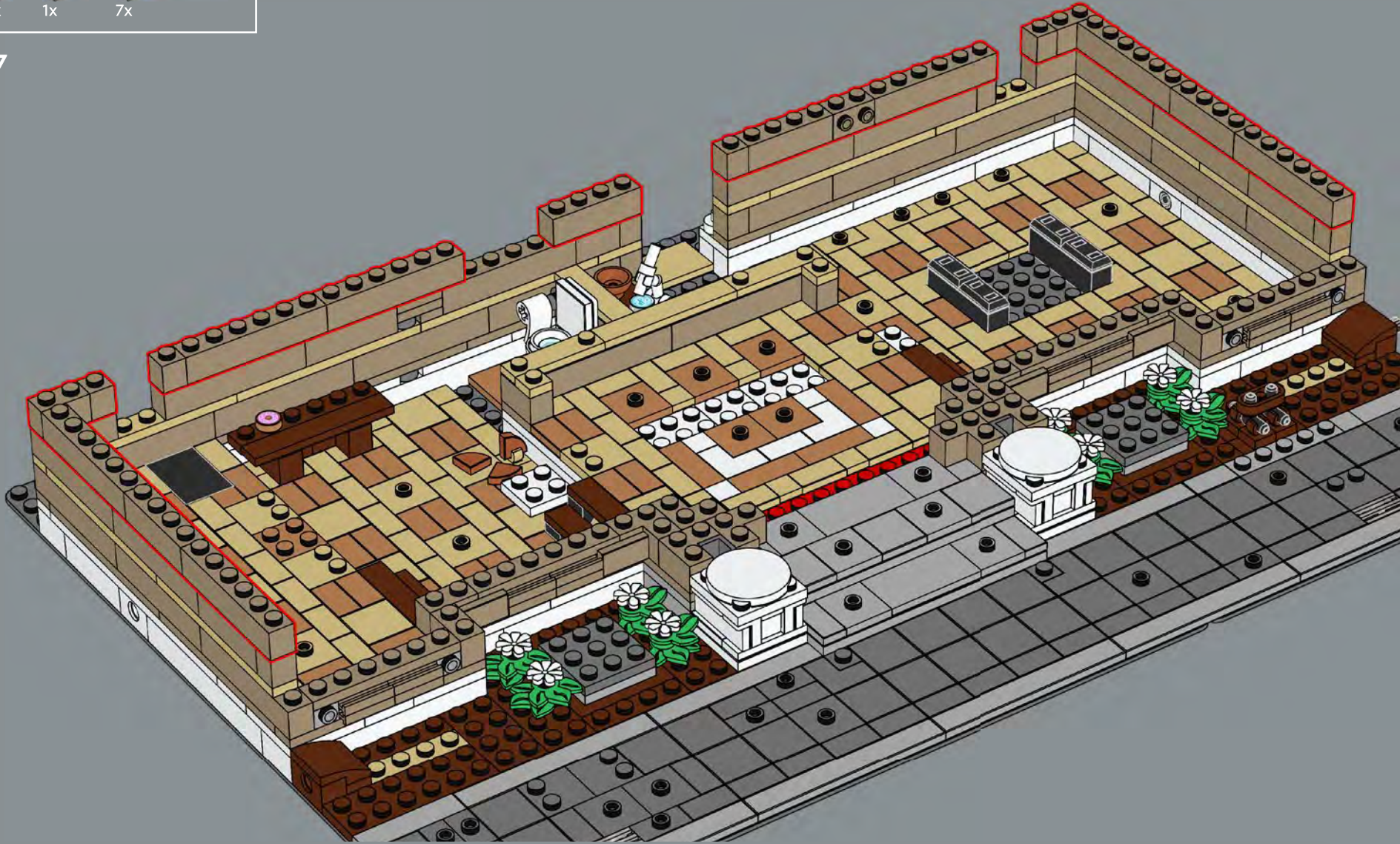

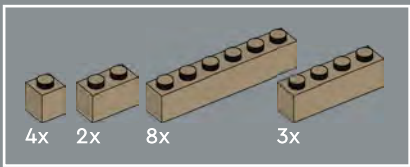

68

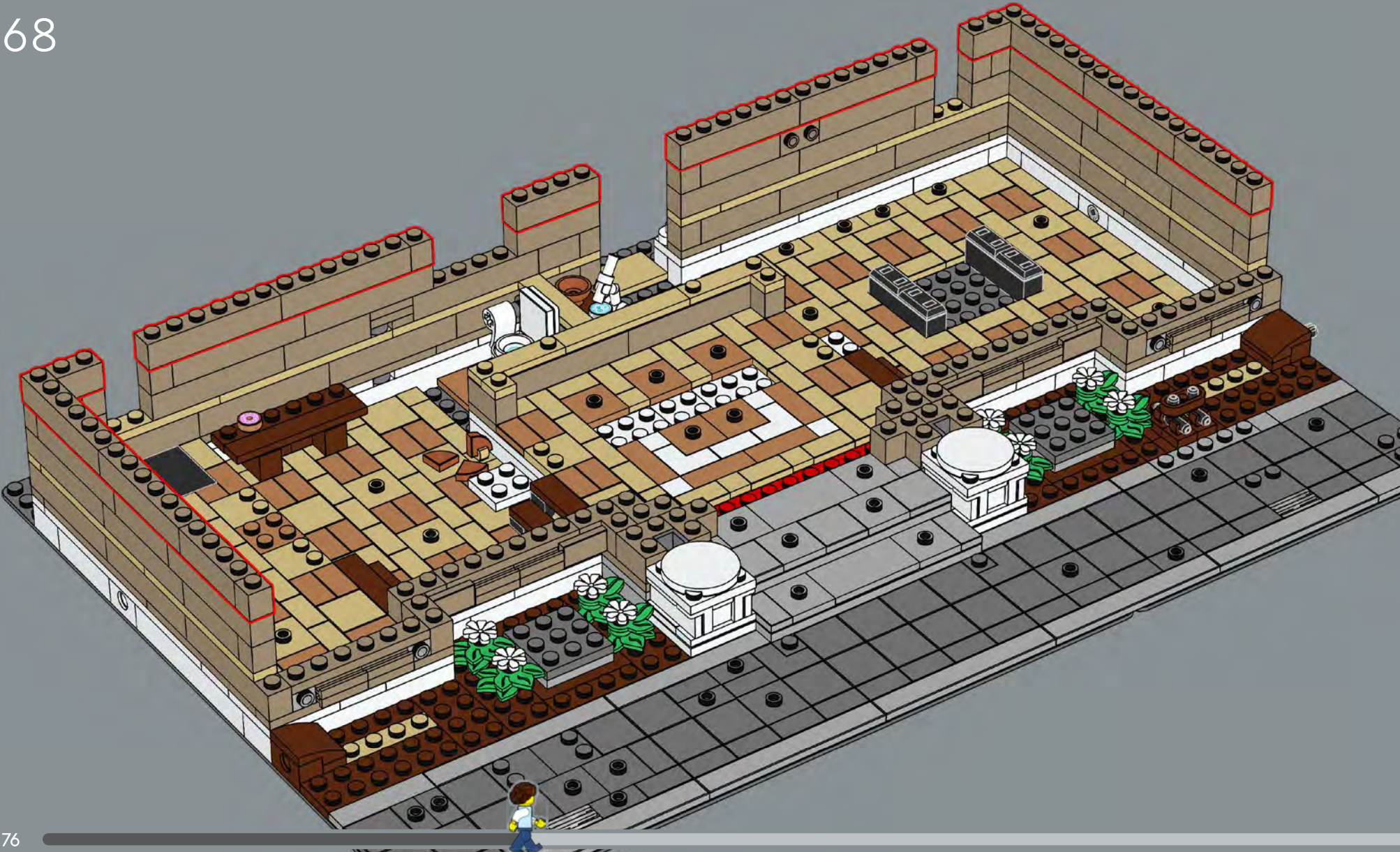

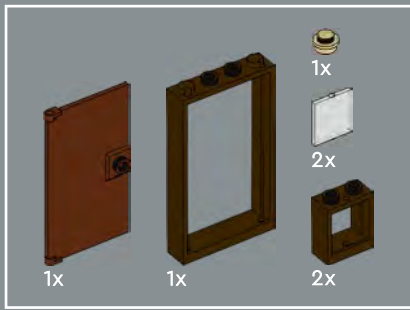

69

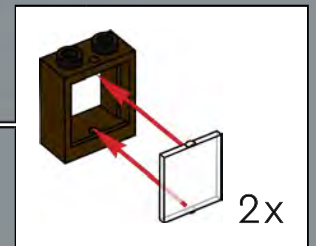
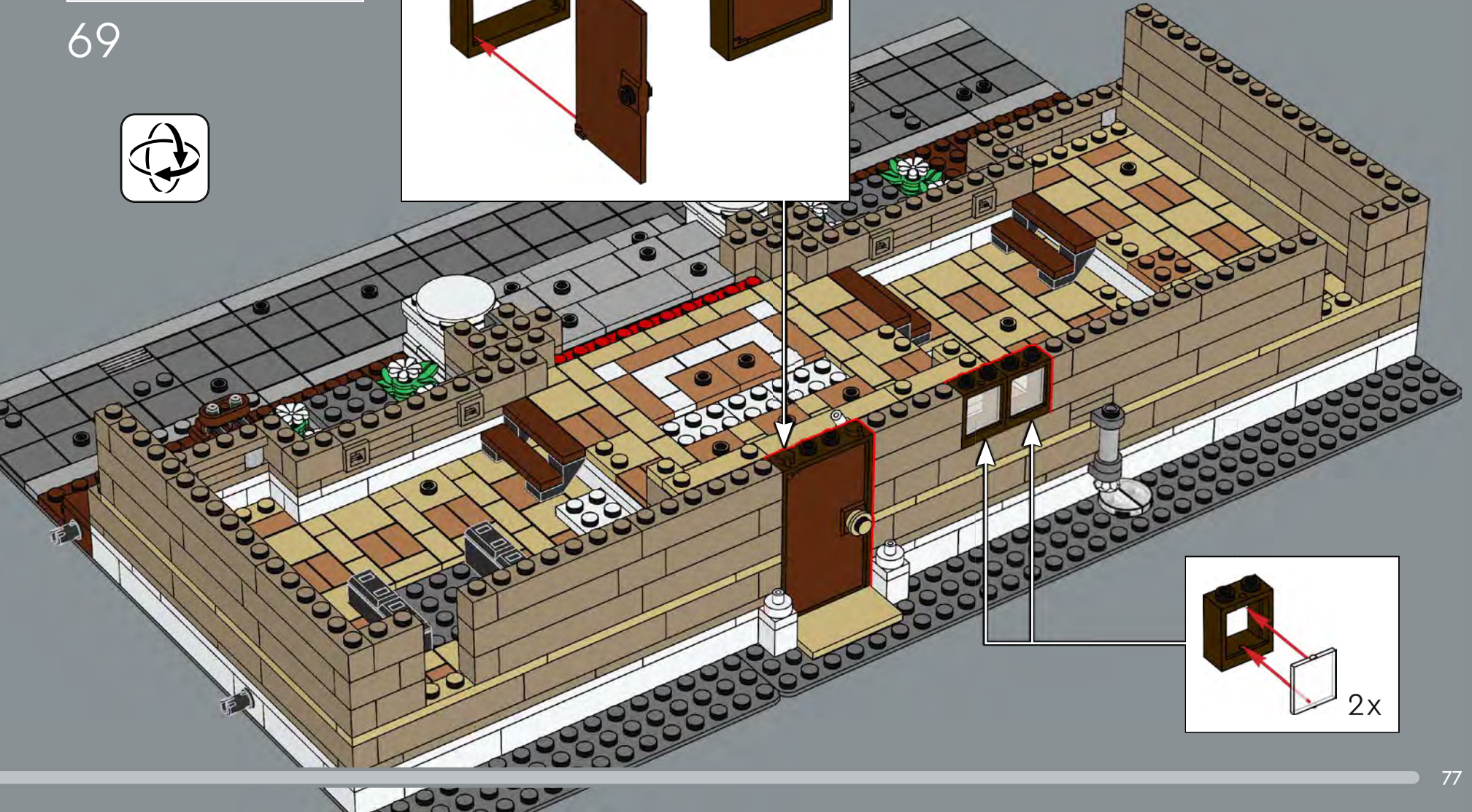
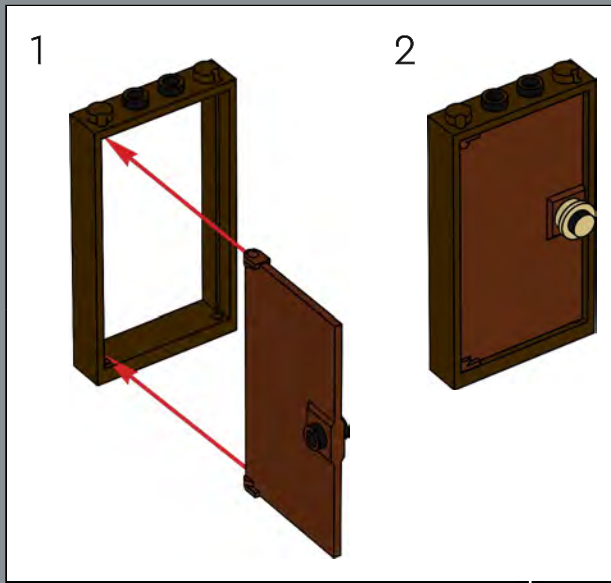



6x

70

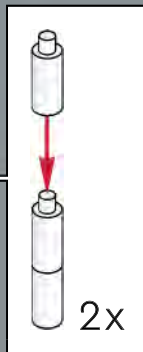
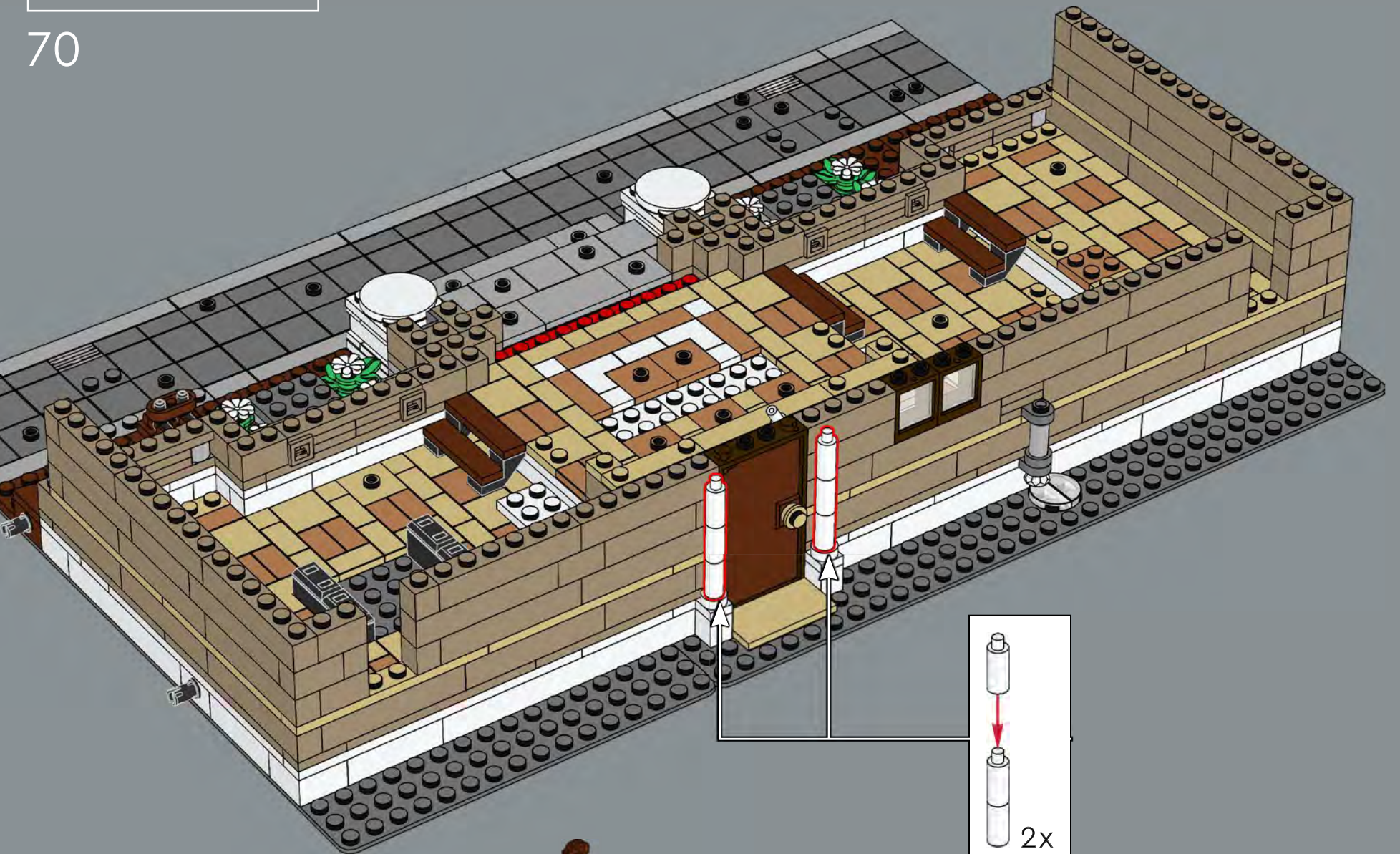

2x



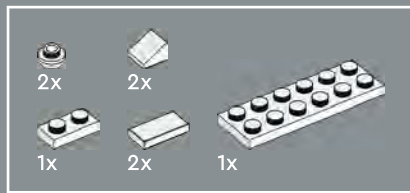

71

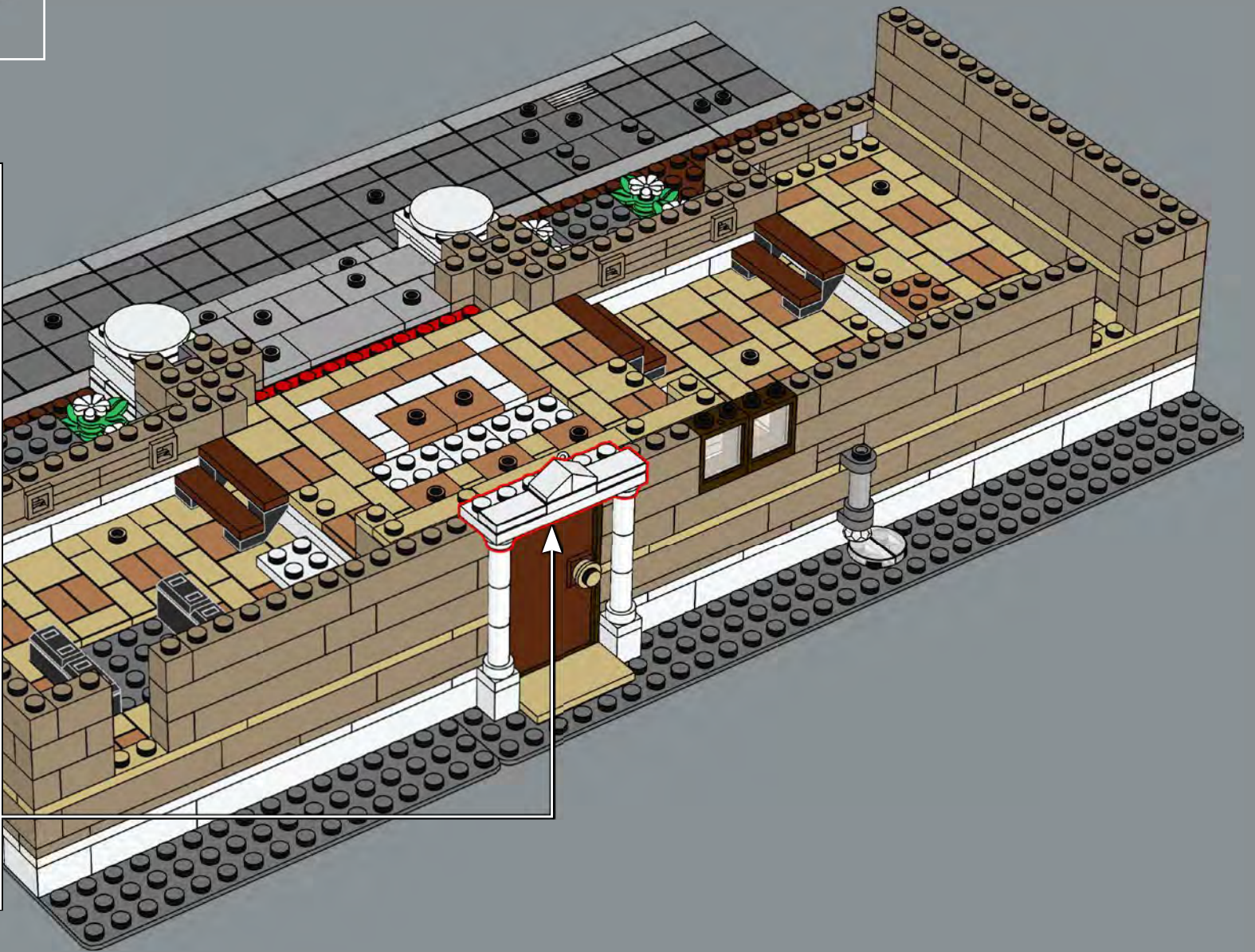
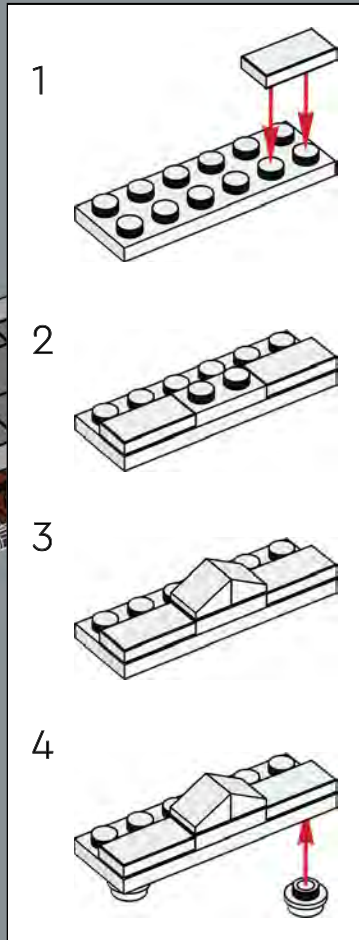

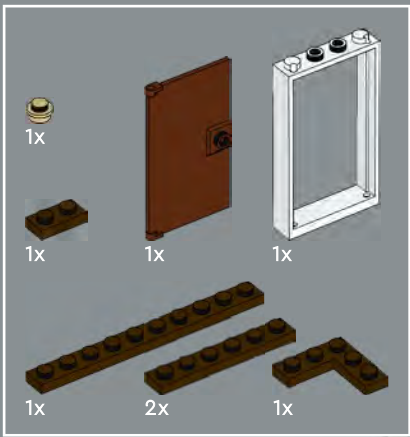

72

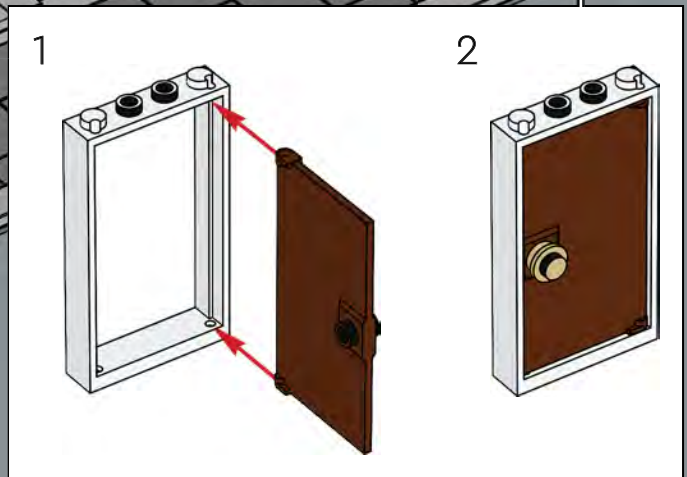
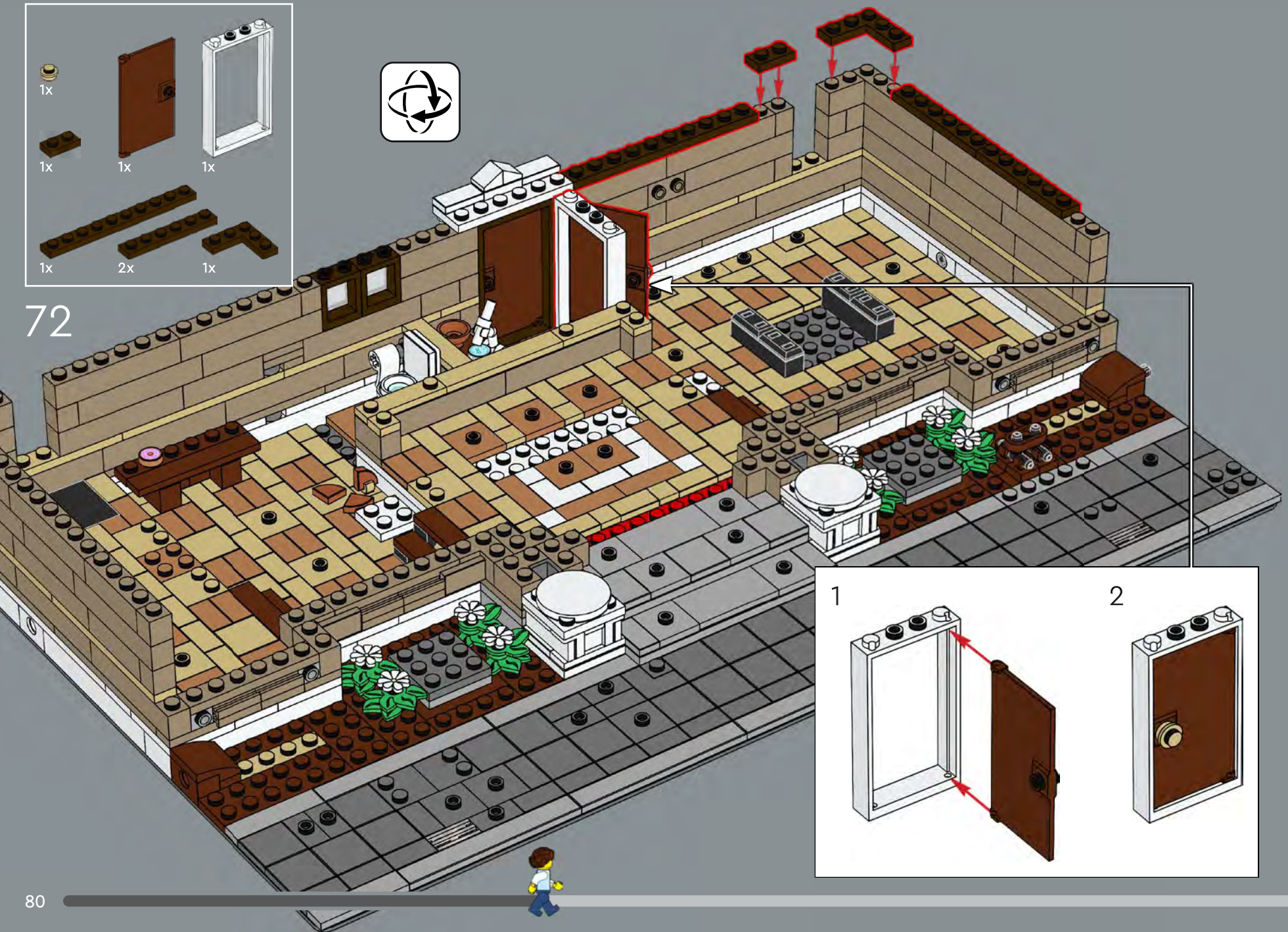

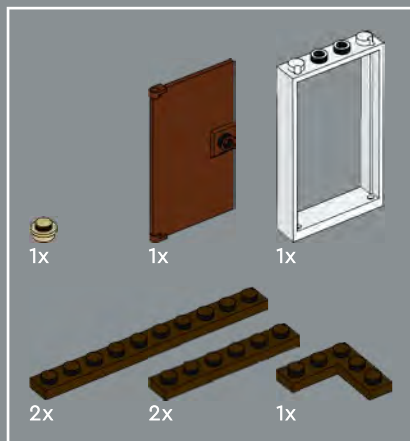

73

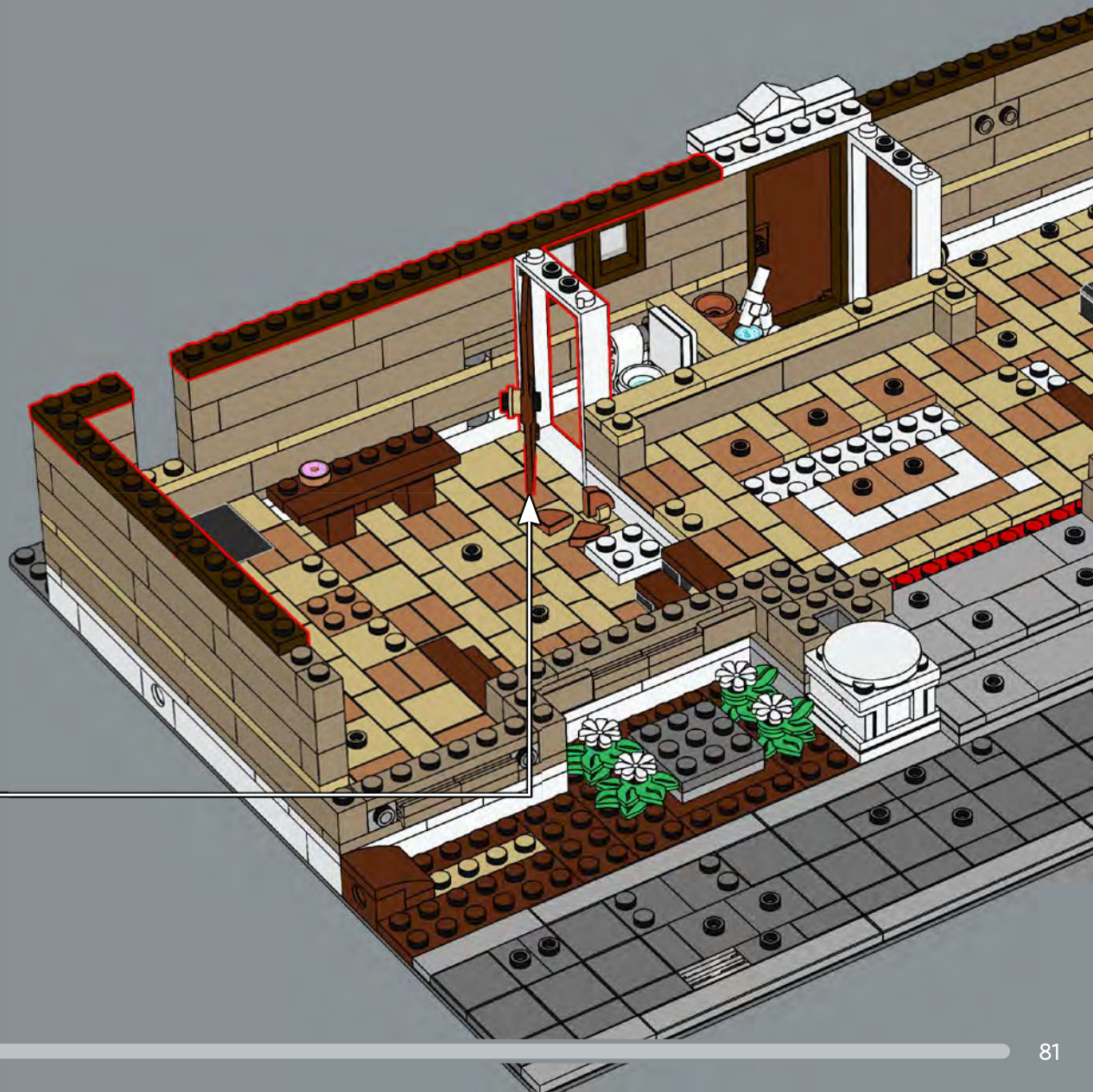
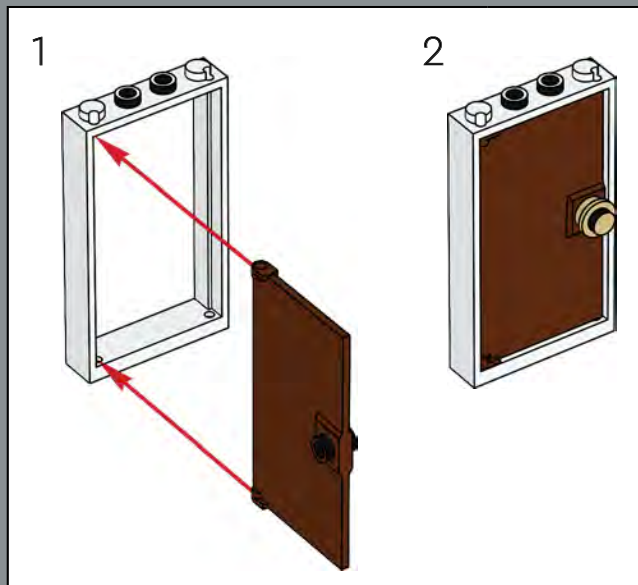

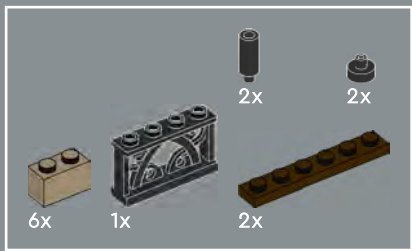

74

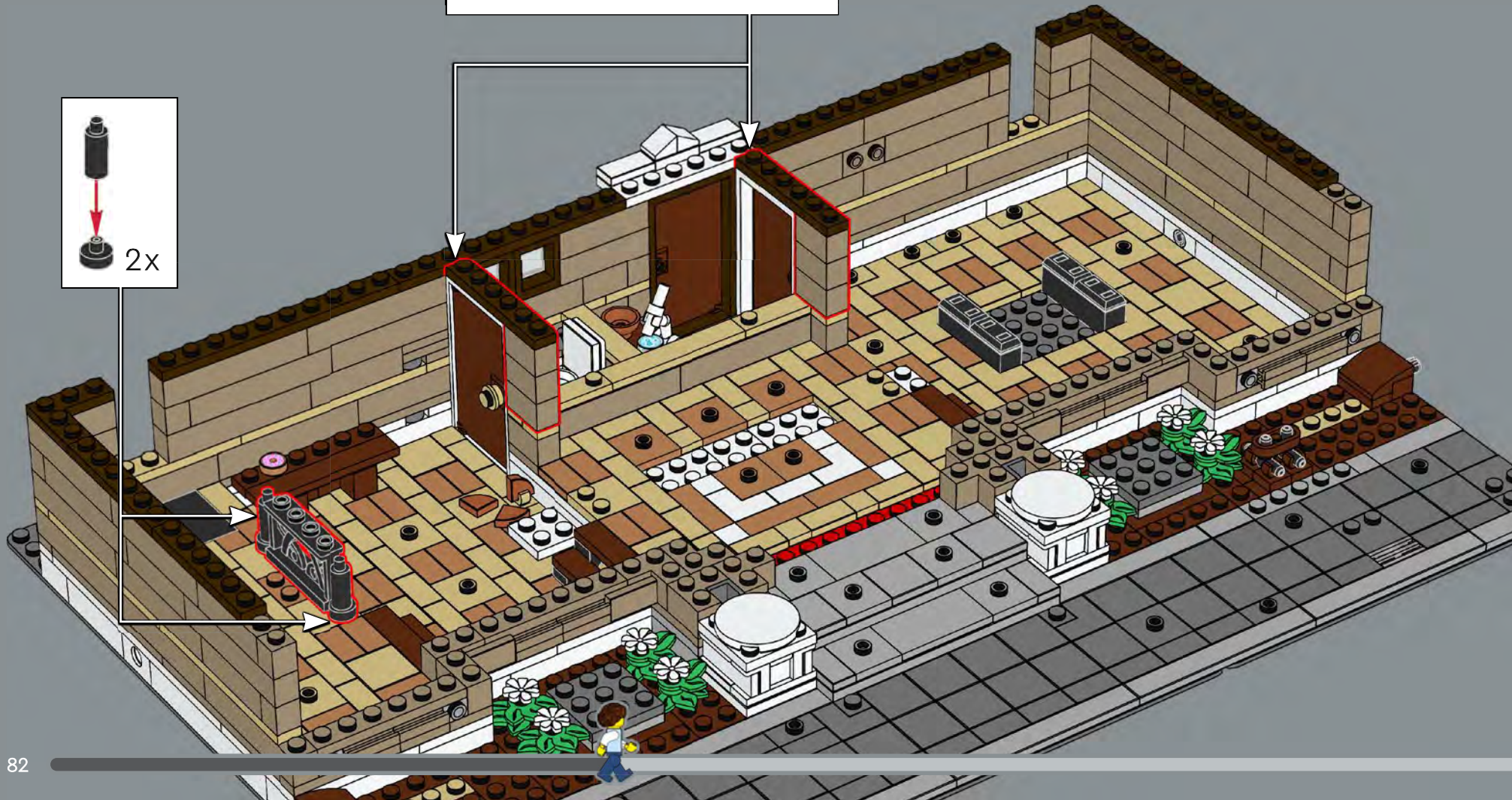
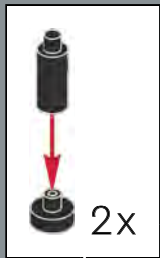
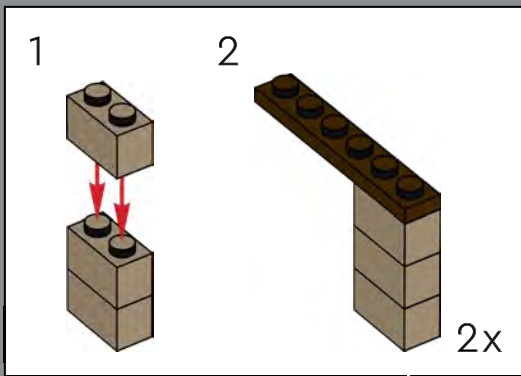

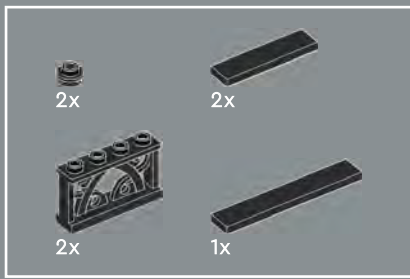

75

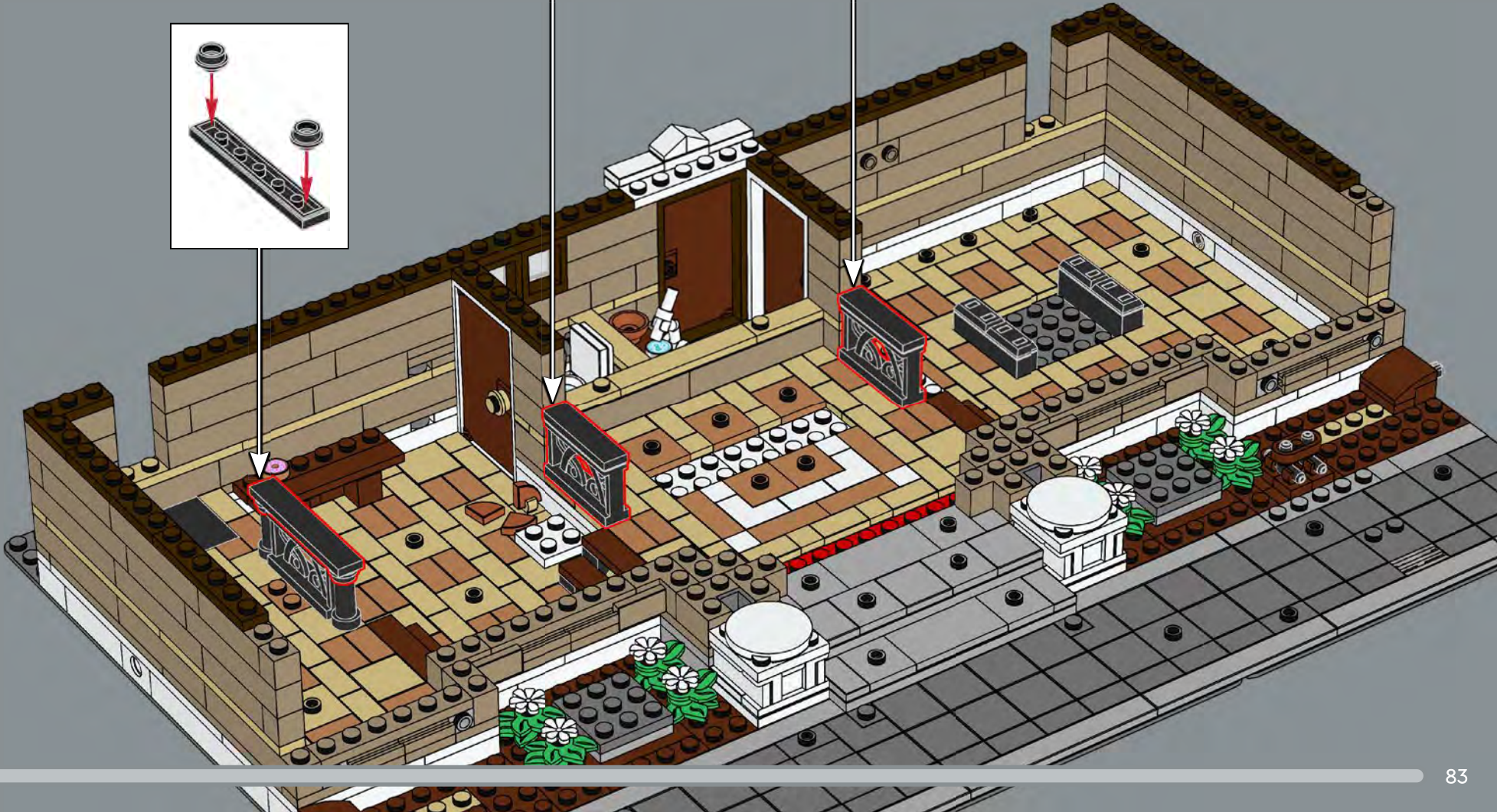
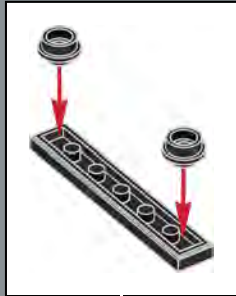
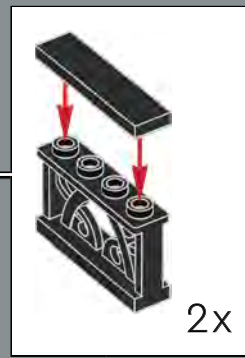

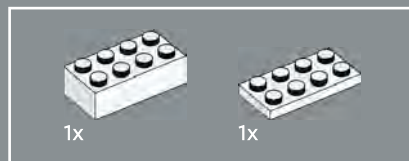
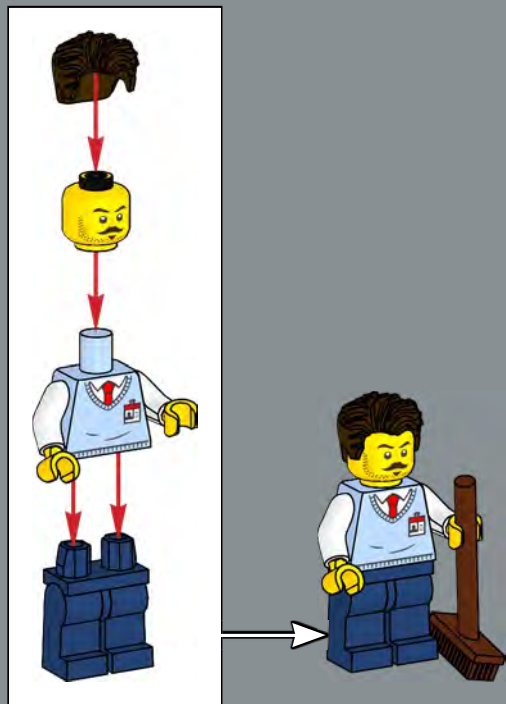

76

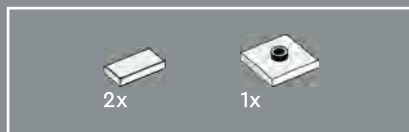
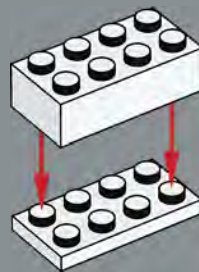

77

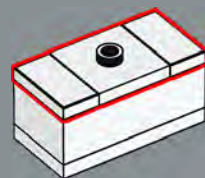

78

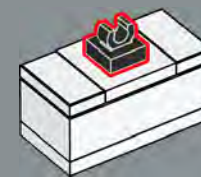

79

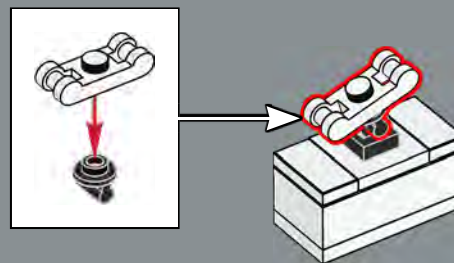



80

1



2



3



4



5



6

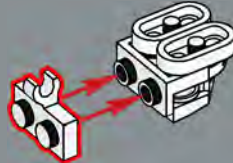

7

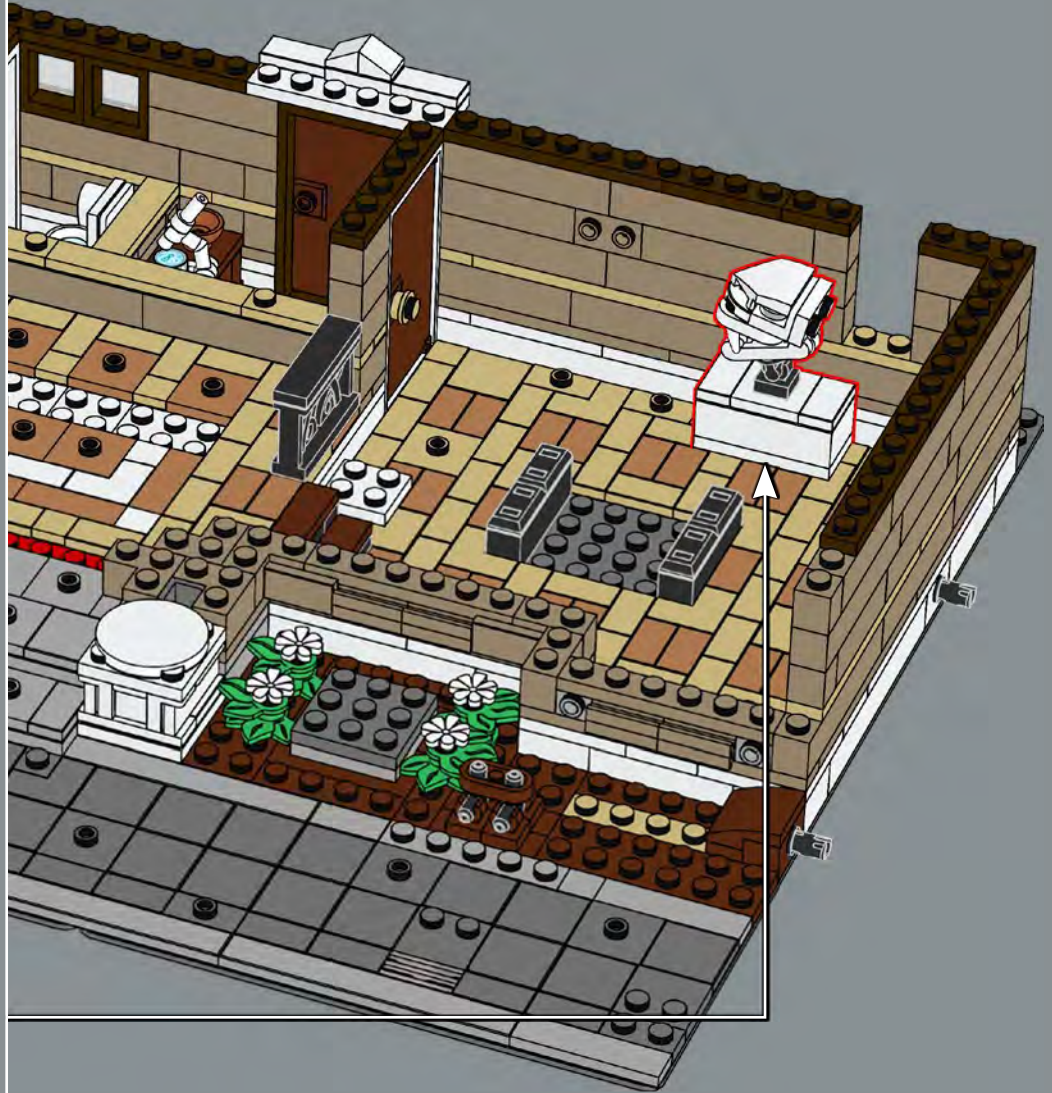
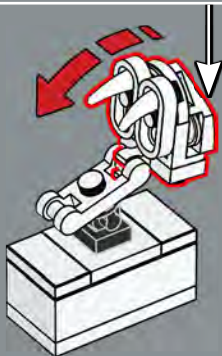

The sabre-toothed tiger skull is another prized artifact in the natural history collection. Did you know that their oversized canine teeth could measure up to 20 cm (7.8 in.) long?

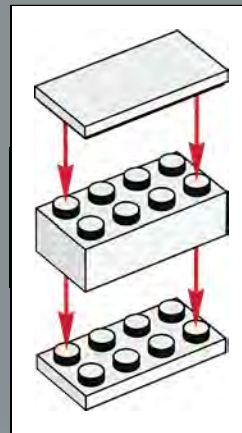
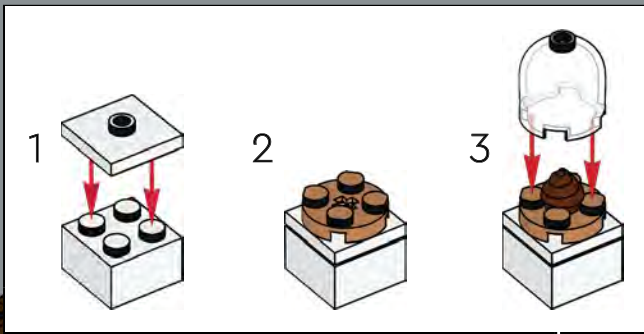
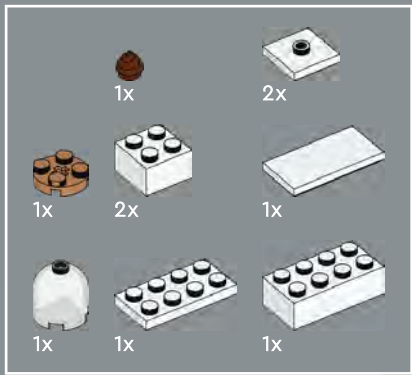

Yes, this is, in fact, dino poo. Fossilised dinosaur waste (coprolite) can actually tell us a lot about a species' diet. The Brachiosaurus, for example, was strictly vegetarian.

81

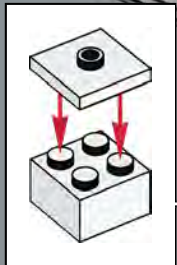

86



82

1



2



3

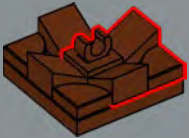

4



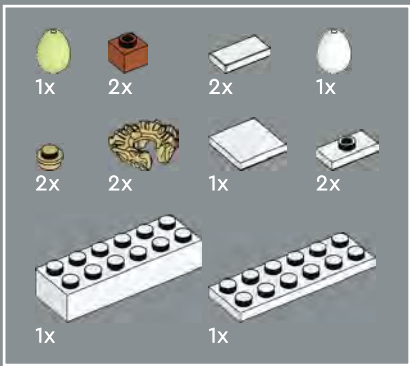

83

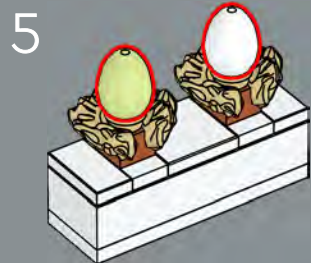
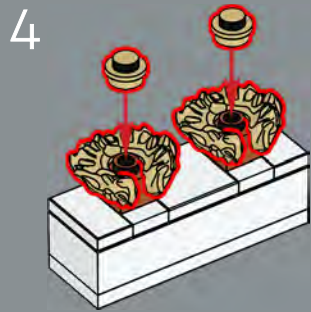
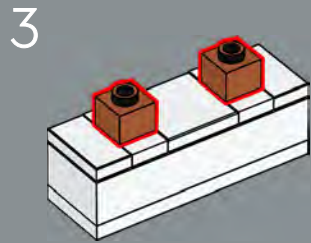
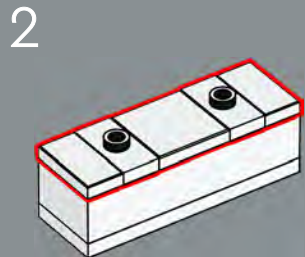
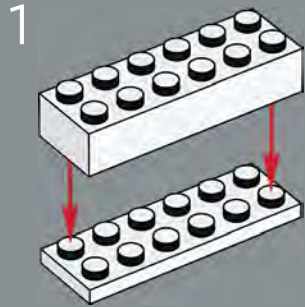

Which came first, the dinosaur or the egg? All we know is that every known species of dinosaur is believed to have reproduced by laying eggs.



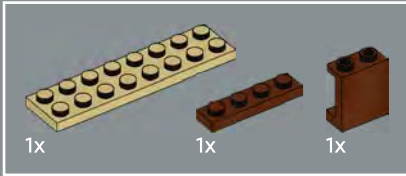

84

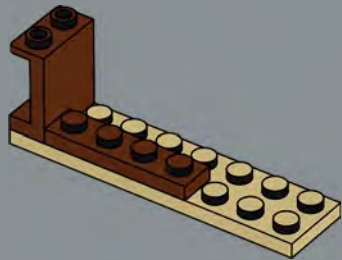

85

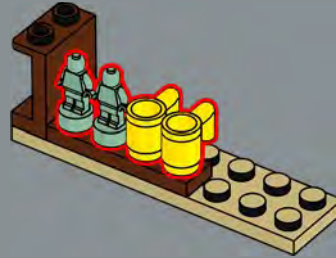

86

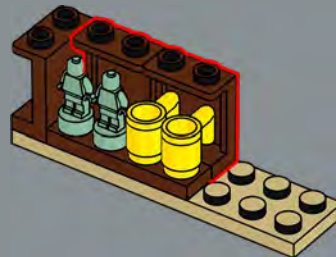

87

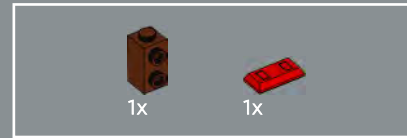
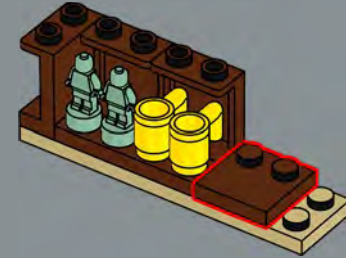

88

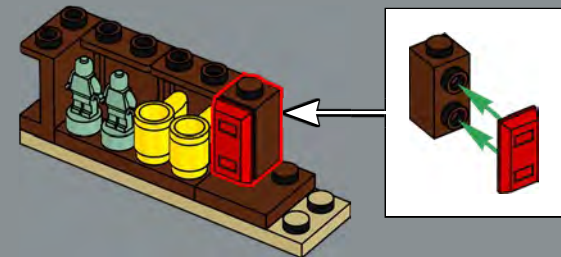

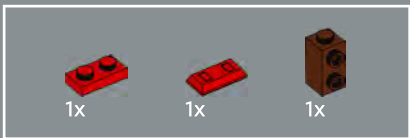

89

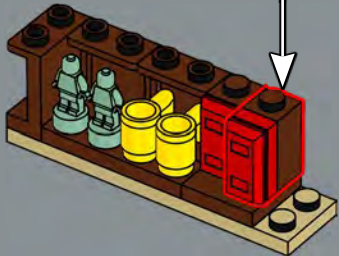
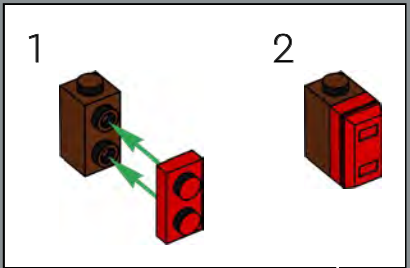

90

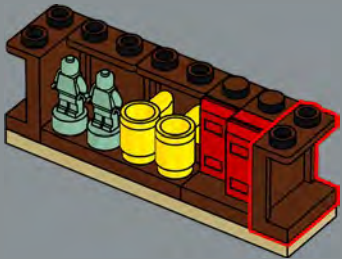

91

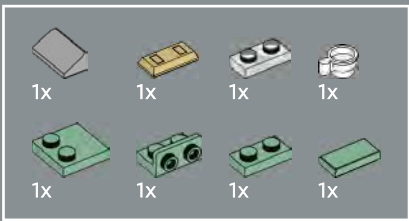

92

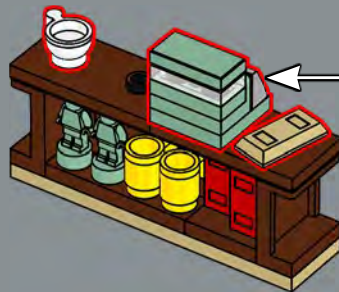
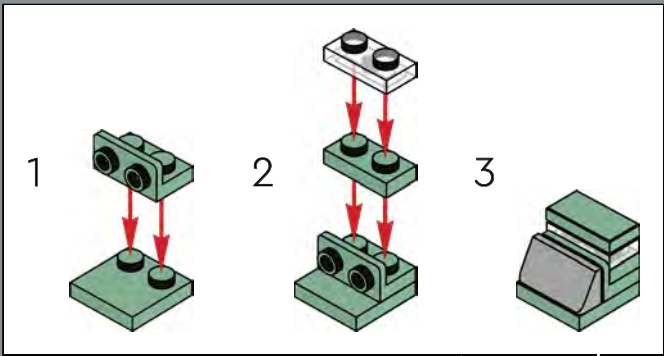



Volcanoes are typically found over mantle plumes and meeting points of tectonic plates. Don't worry, this model of an active volcano is completely safe to explore.

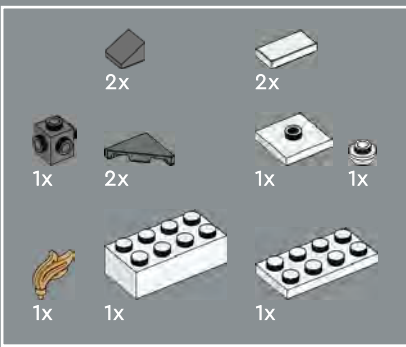

94

1

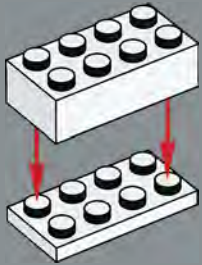

2

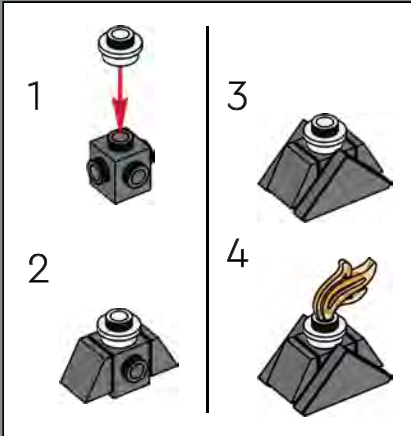
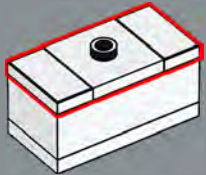

3

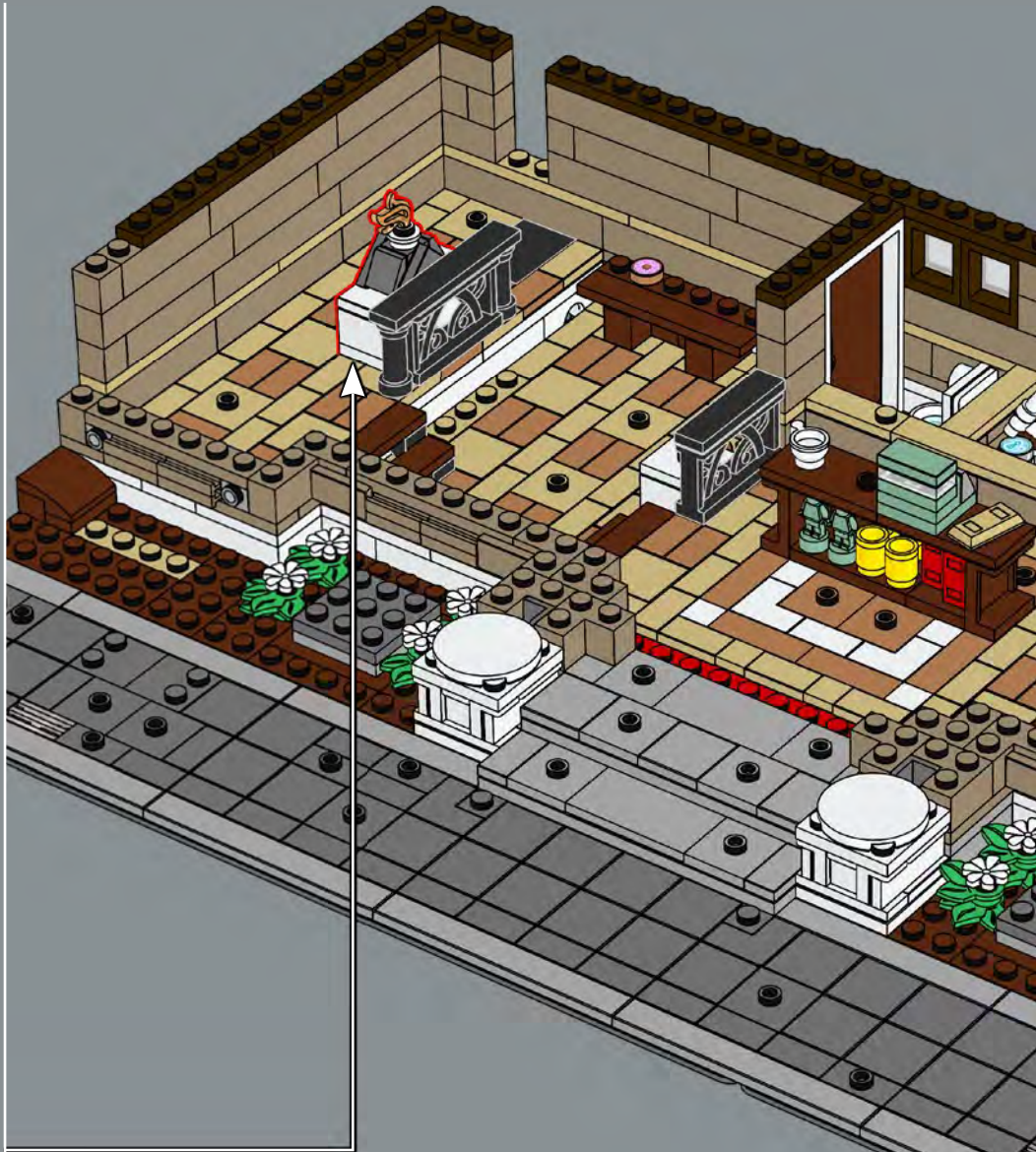
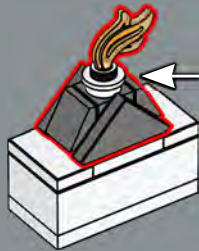

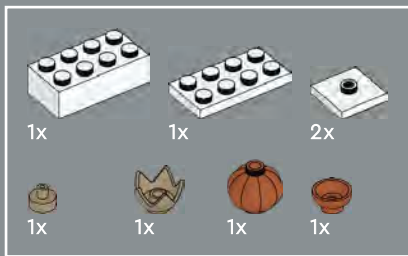

95

1

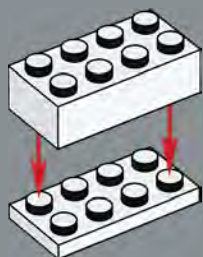

2

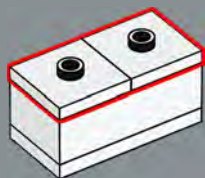

3

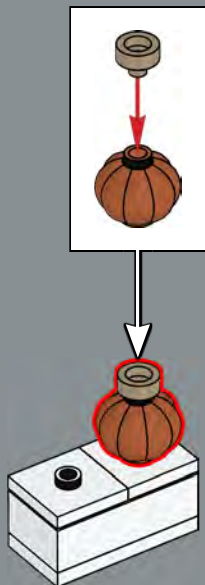

4



These highly detailed replicas of ancient pottery were created specifically for the museum by the artist living above the 10243 Parisian Restaurant.



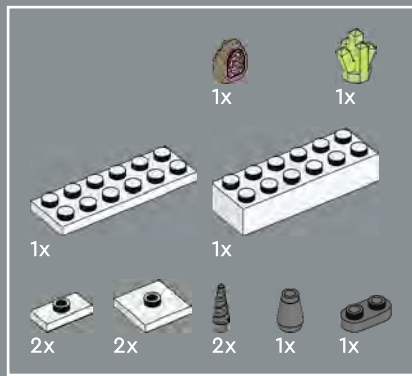

96

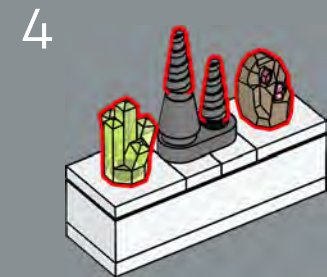
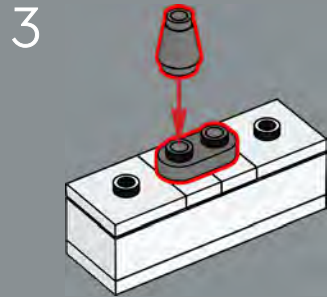
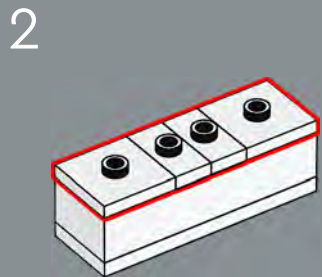
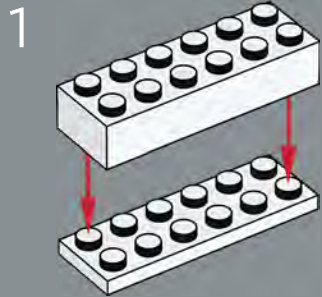

This part of the natural history collection really rocks. These types of quartz, geodes and stalagmites have been collected from all over the world.





97

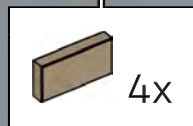
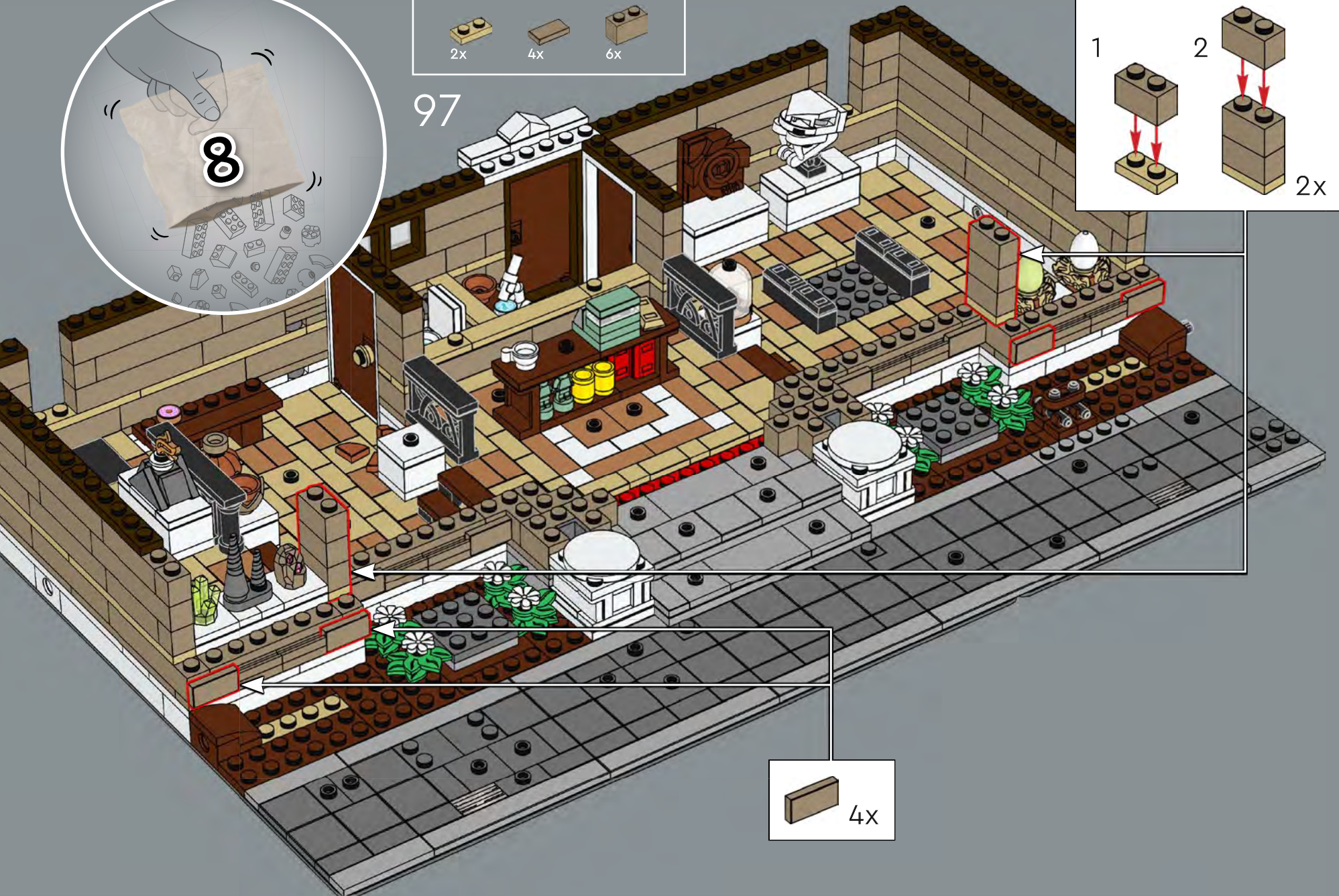
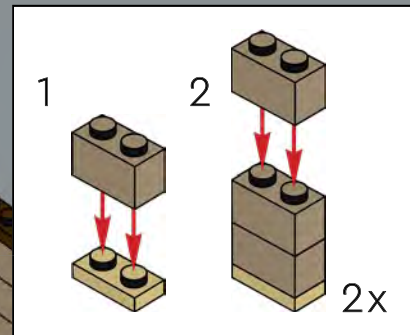

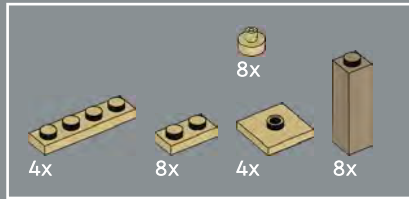

98

1

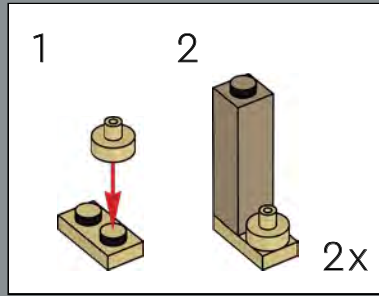
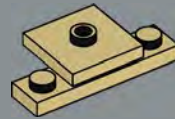

2

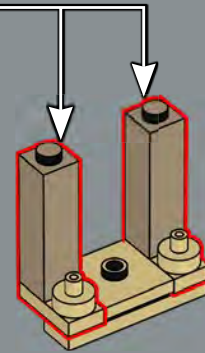

4x





99

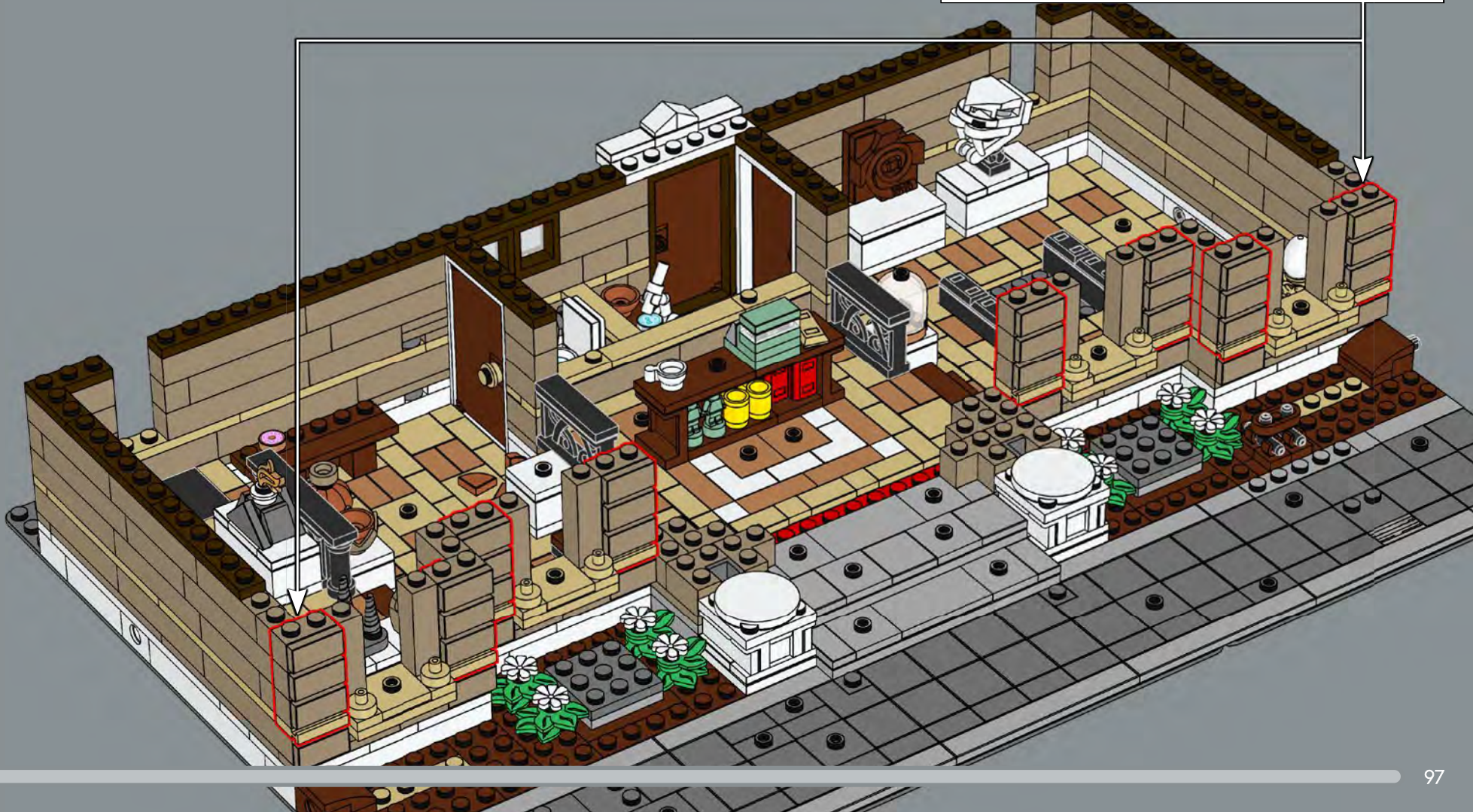
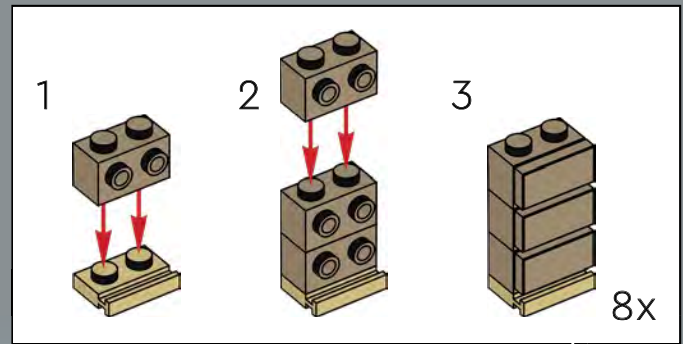

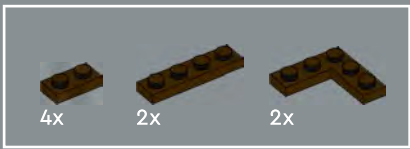

100

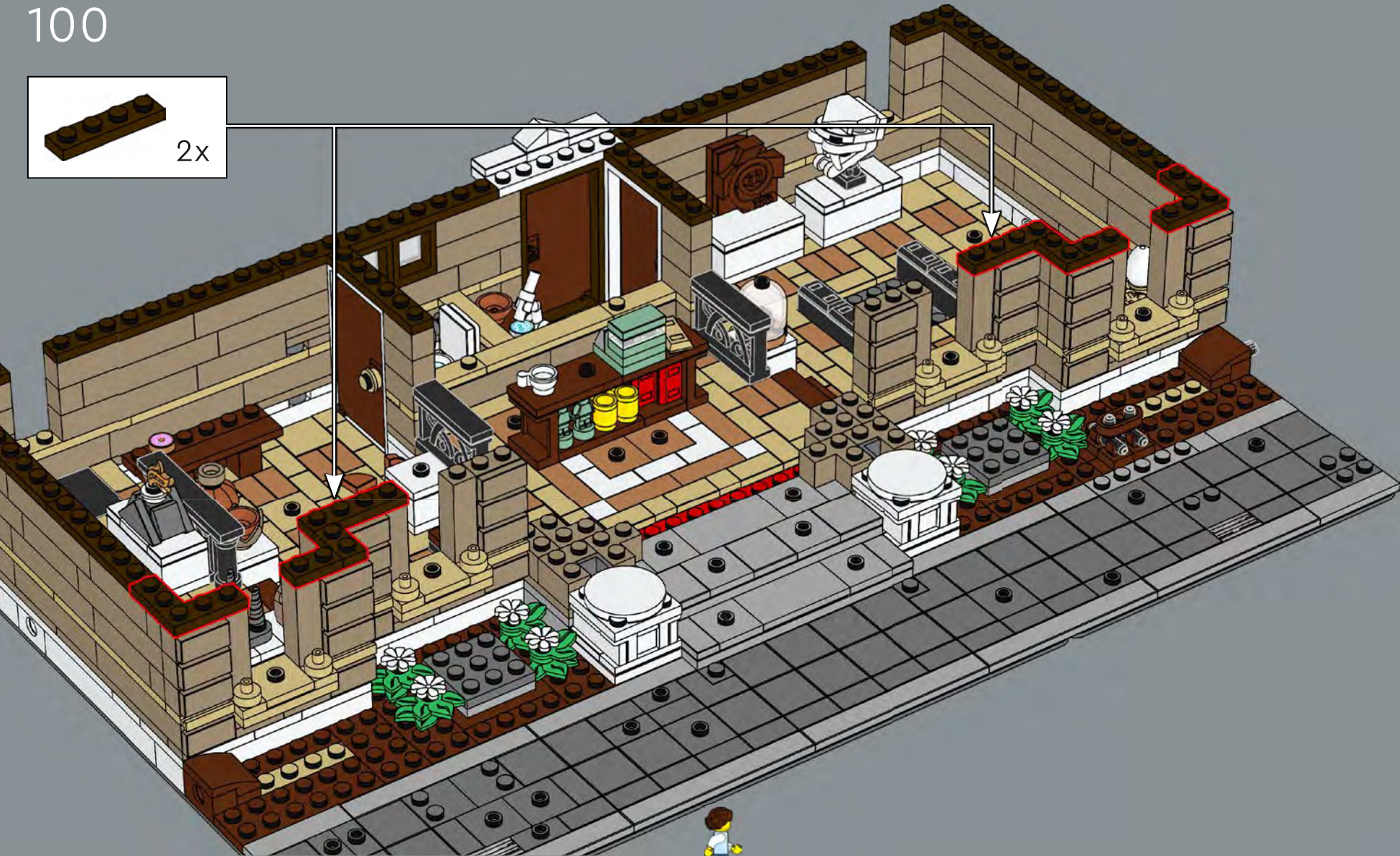

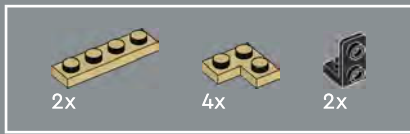

101





102

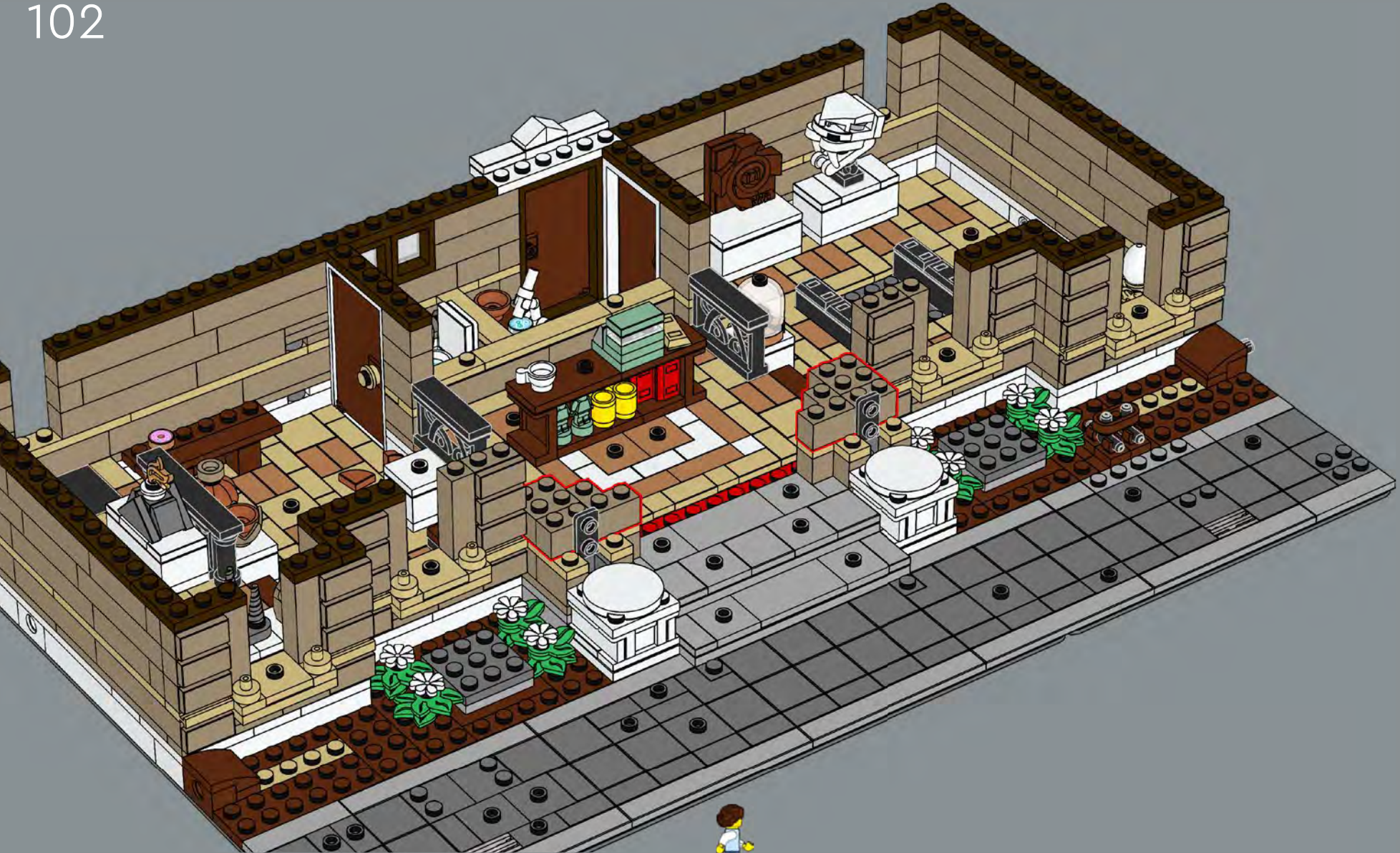

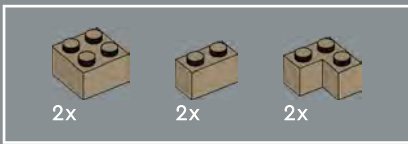

103

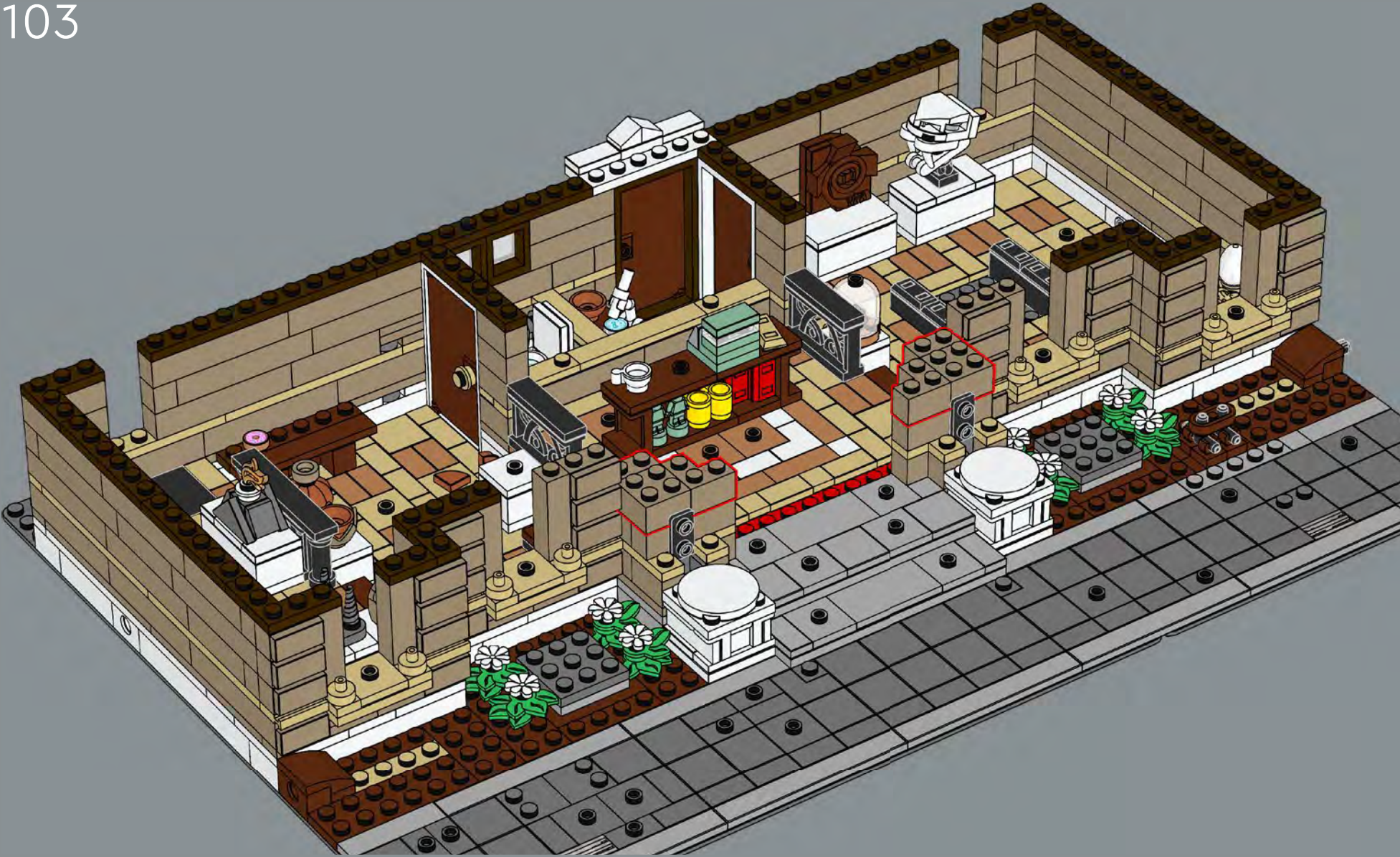

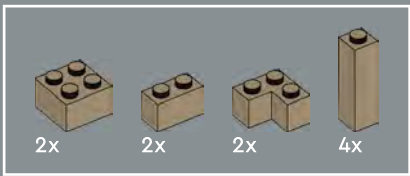

104

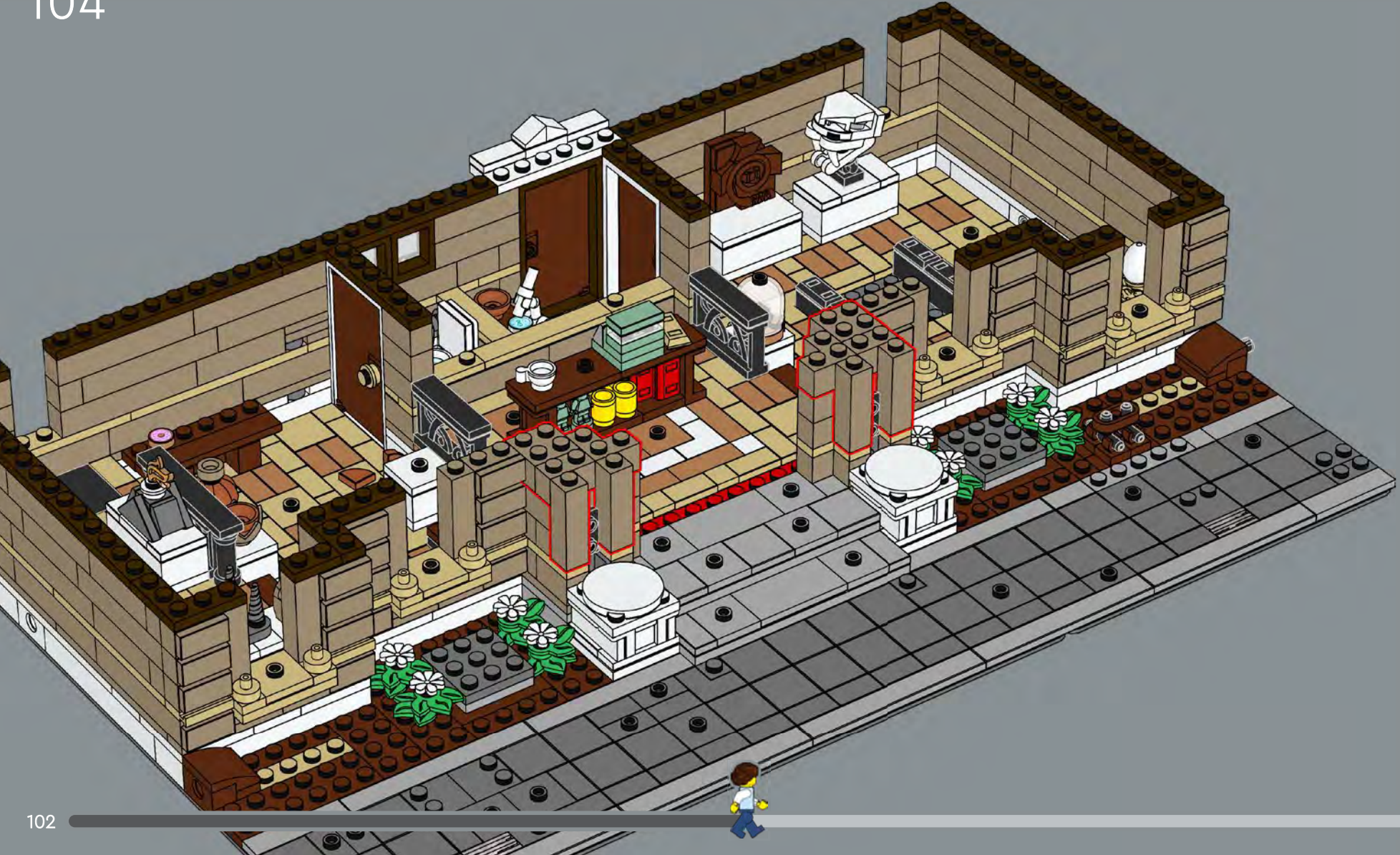



105

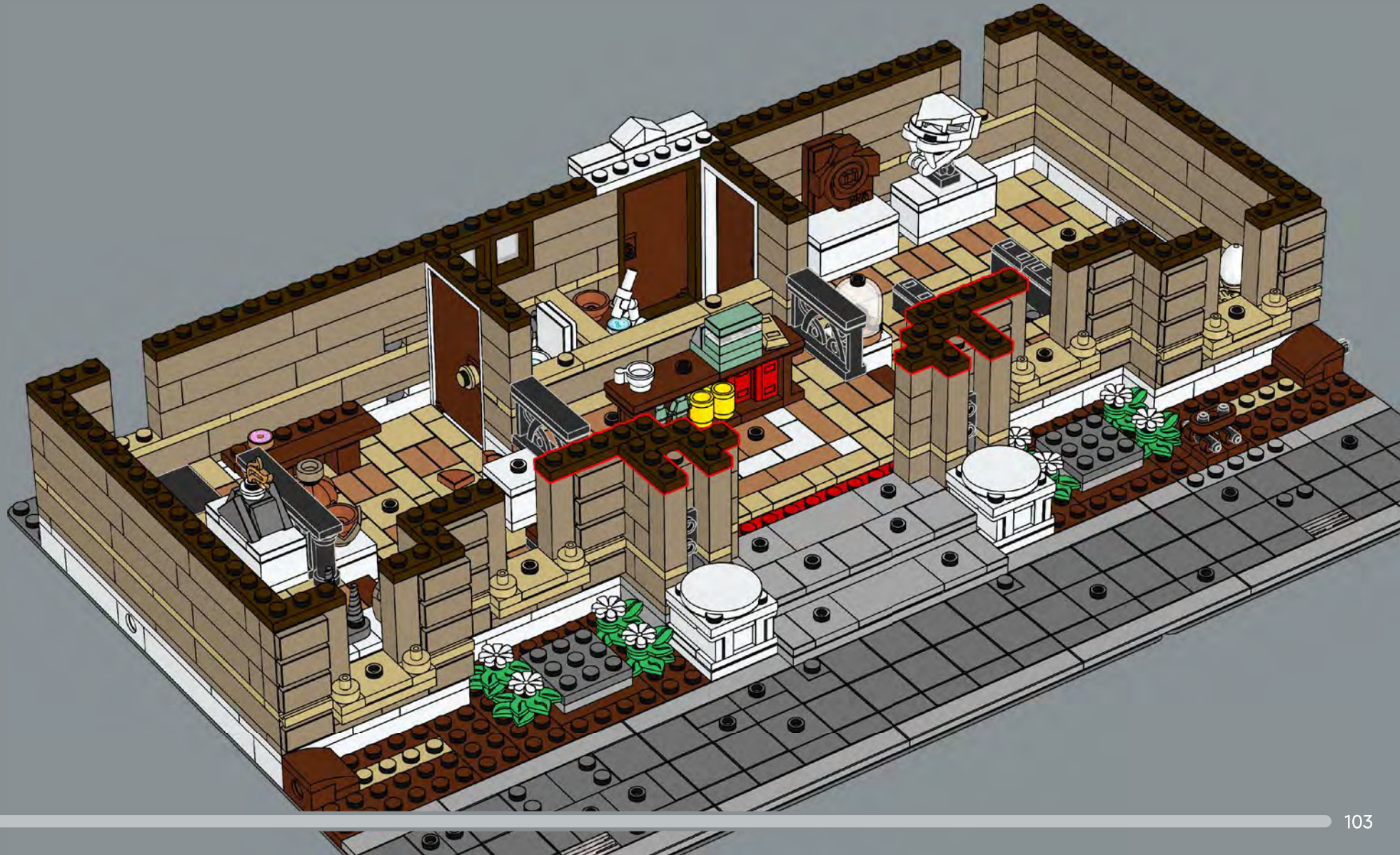

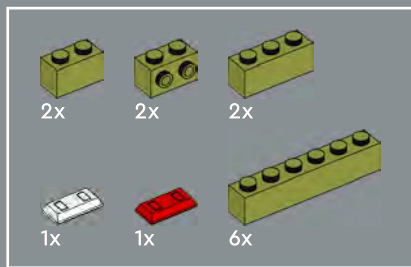

106

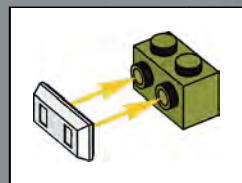
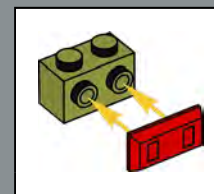

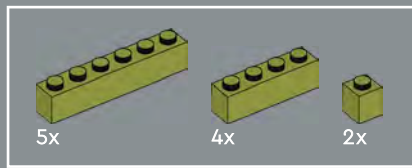

107

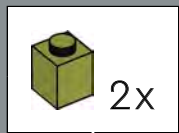

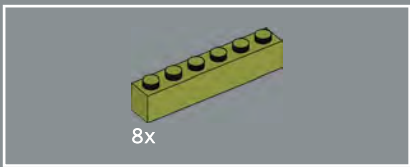

108



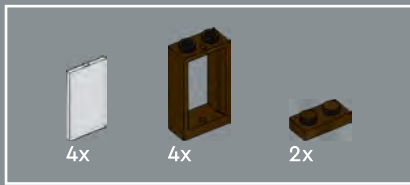

109

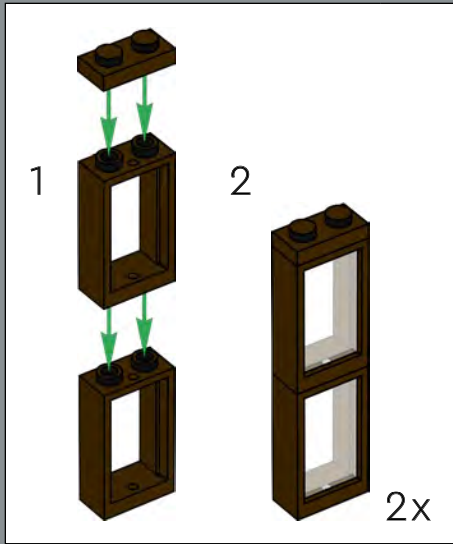

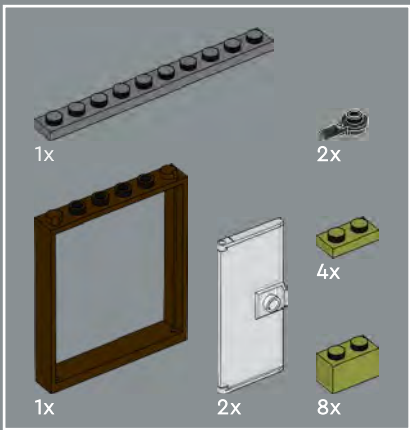

110

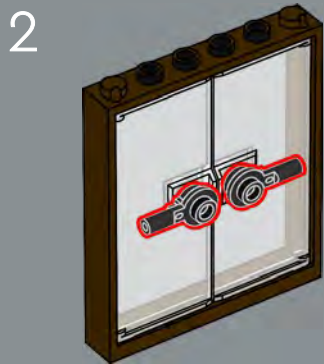
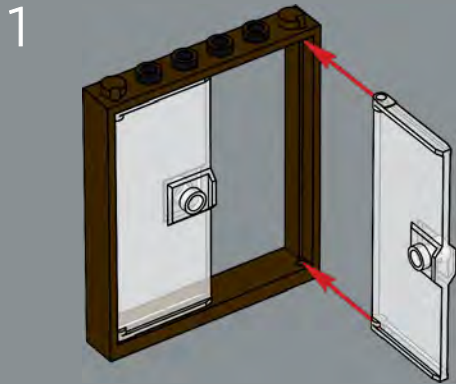

3

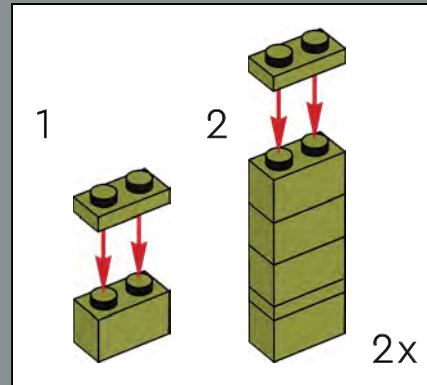
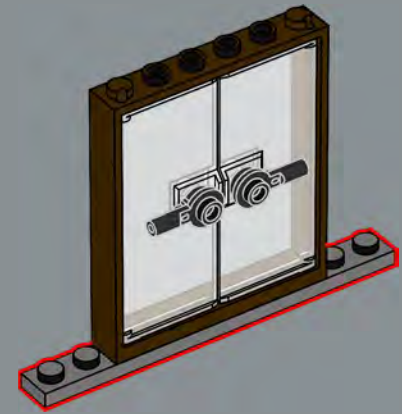

4

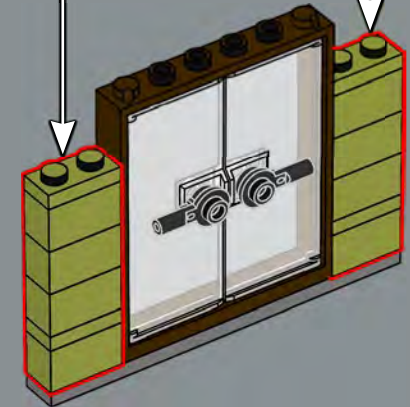



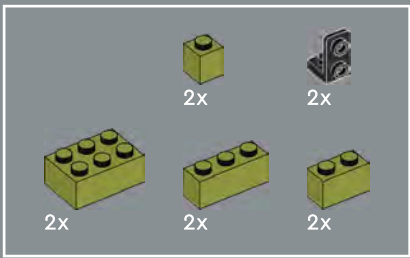

111

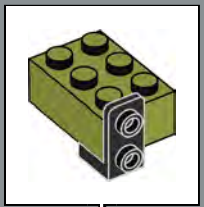
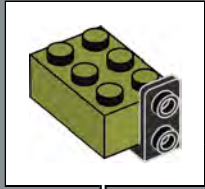

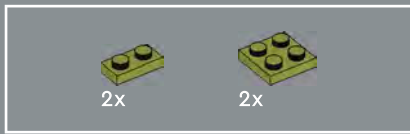

112



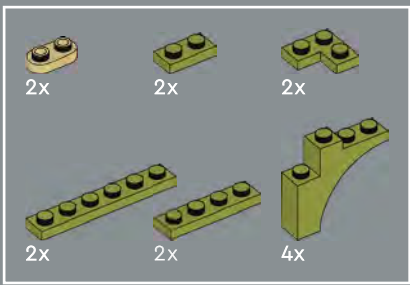

113

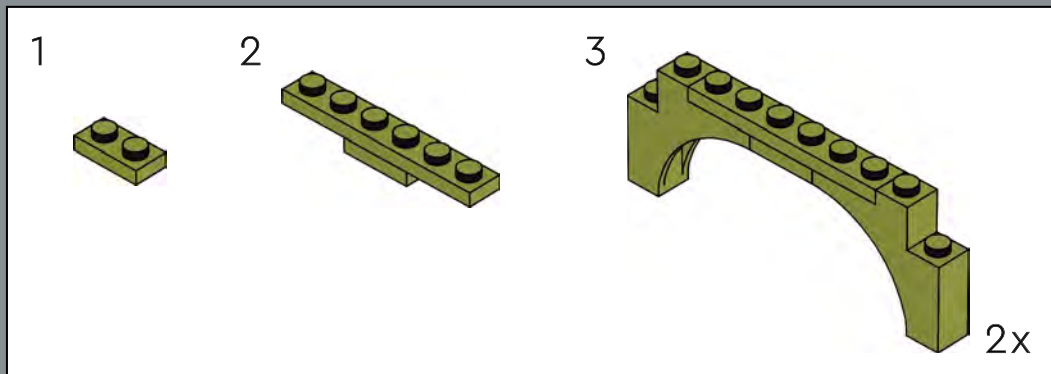



114



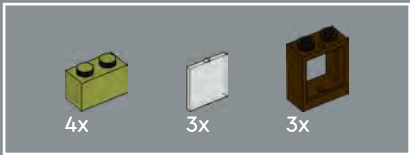

115

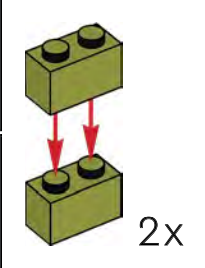
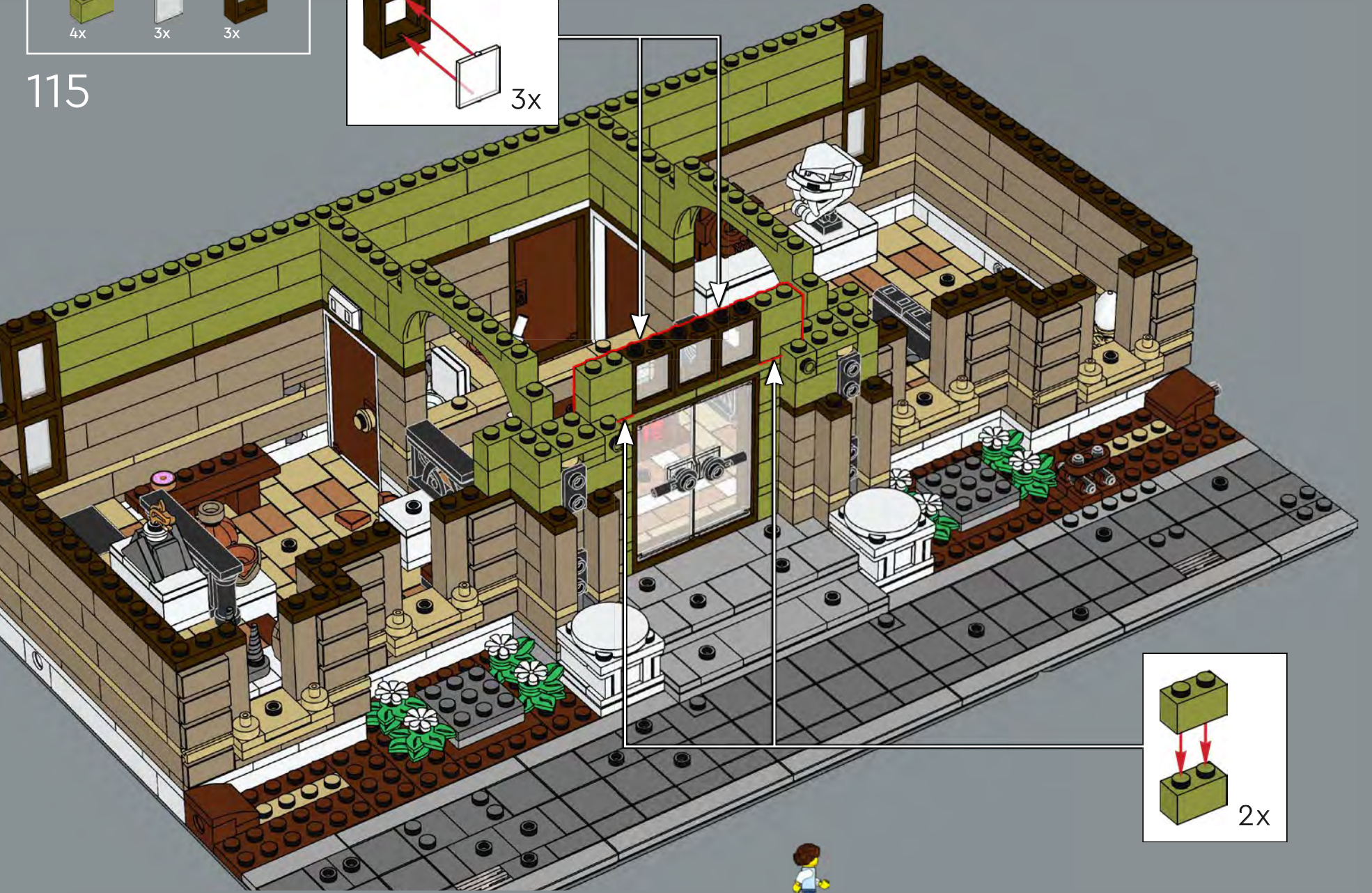
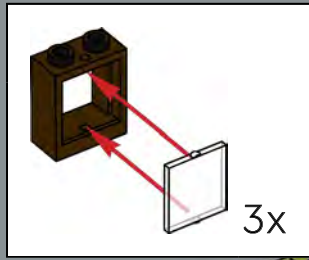

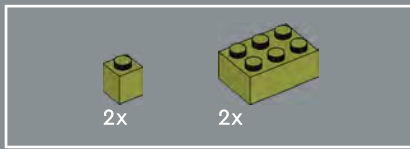

116





117

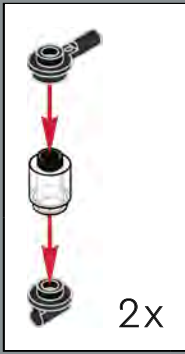

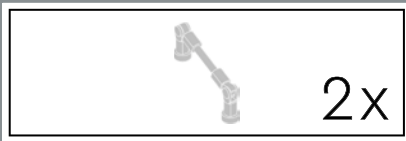

118

1



2

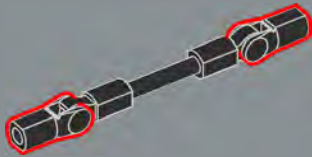

3

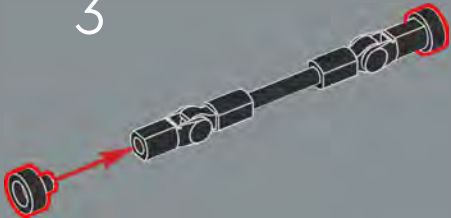

2x

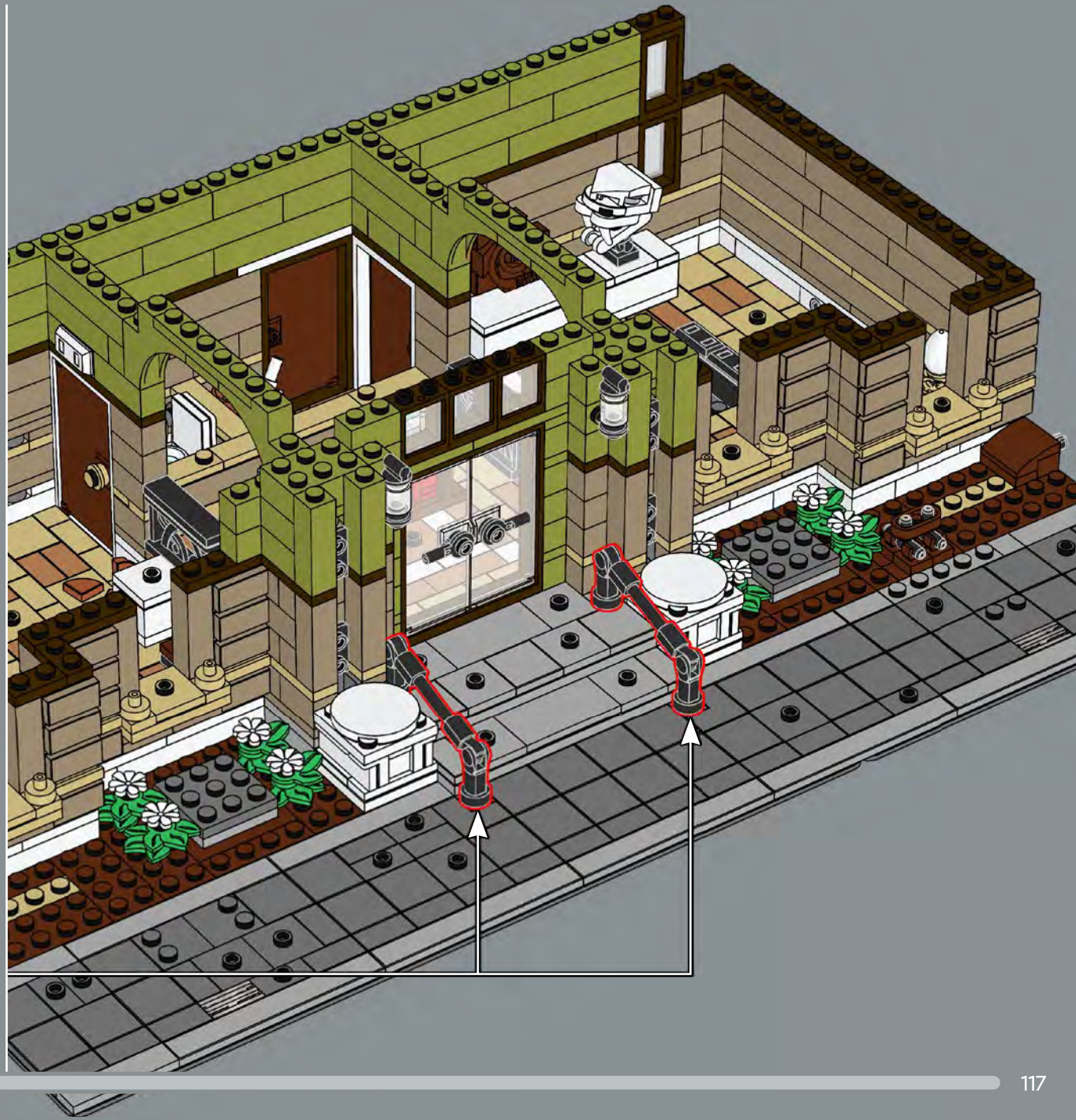

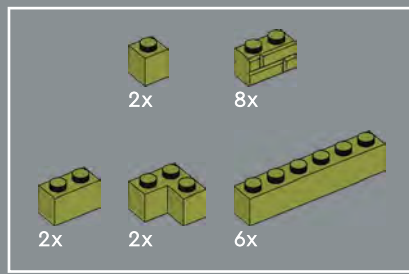

119



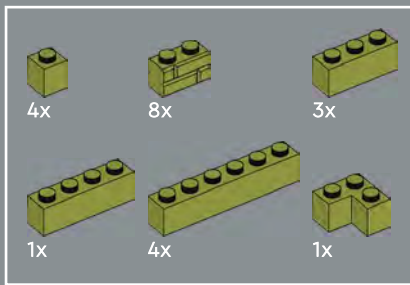

120



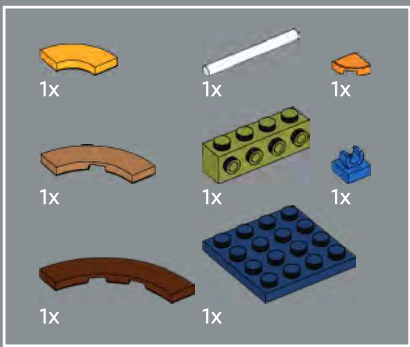

121

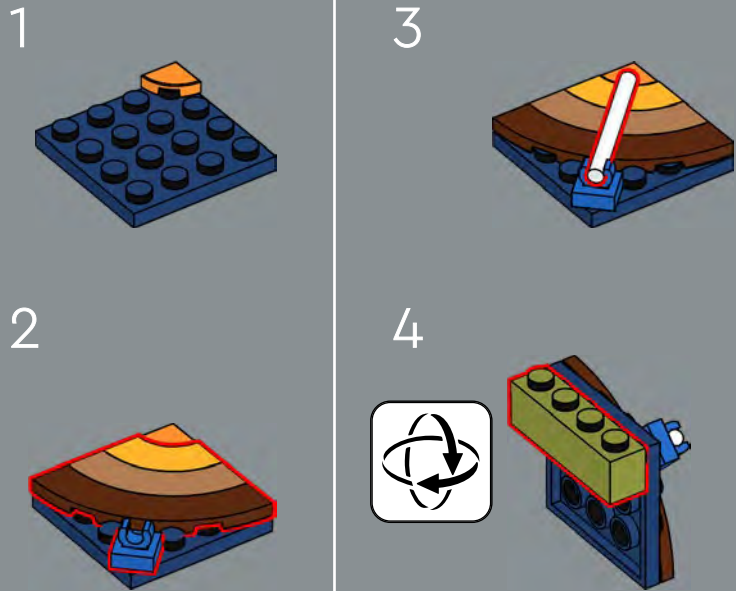

What on (and in) Earth is going on? The Earth's hot inner core (orange) is encapsulated by the molten outer core (yellow), the mantle (light brown) and the crust which supports all known life!



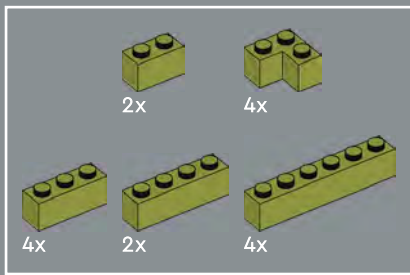

122





16x

123



8x





124

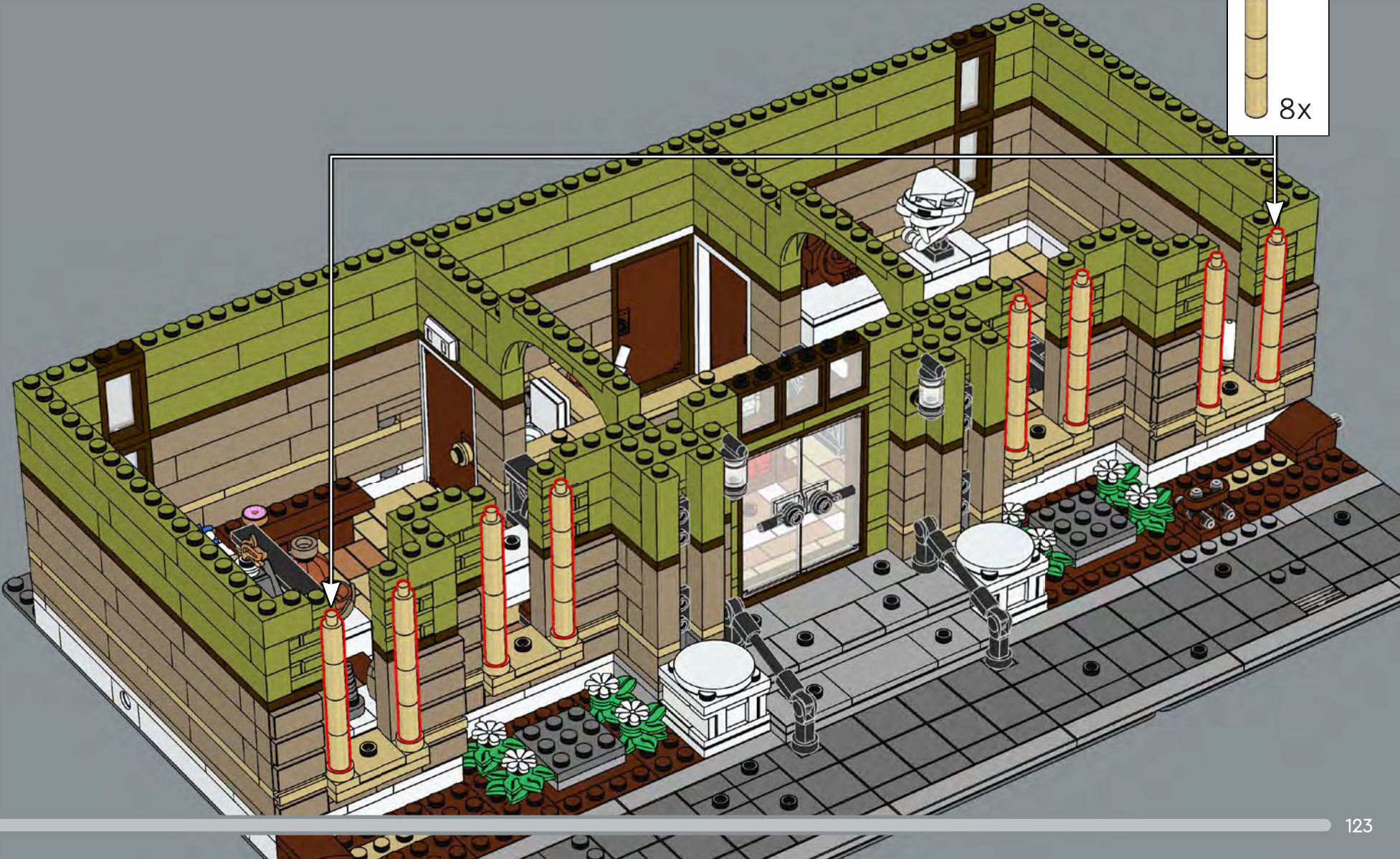
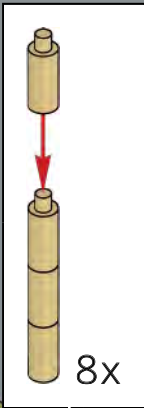



125

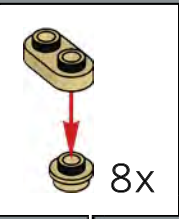

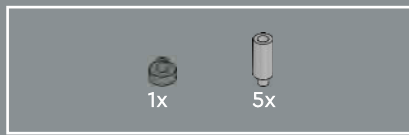

126

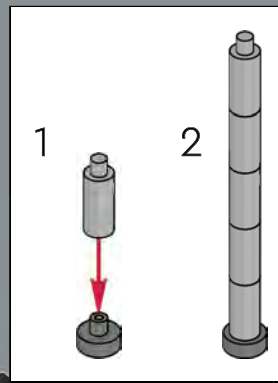

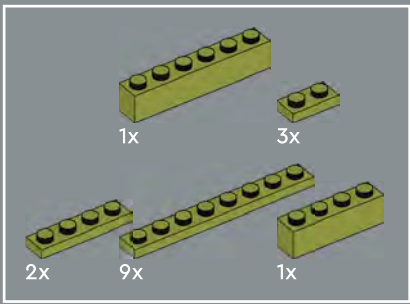

127



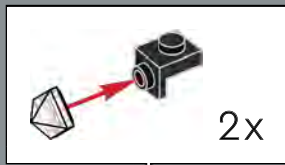
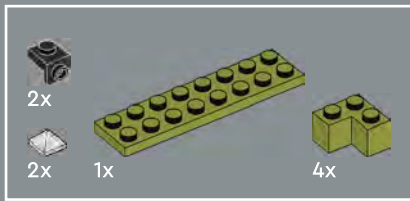

128



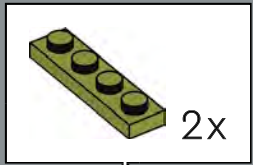
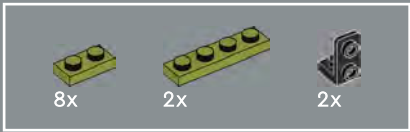

129



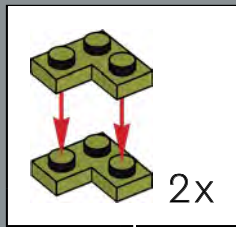
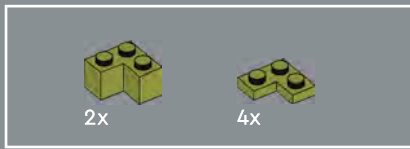

130



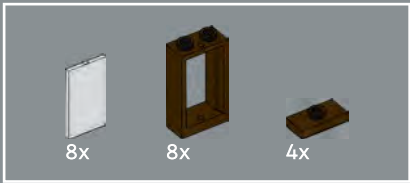

131

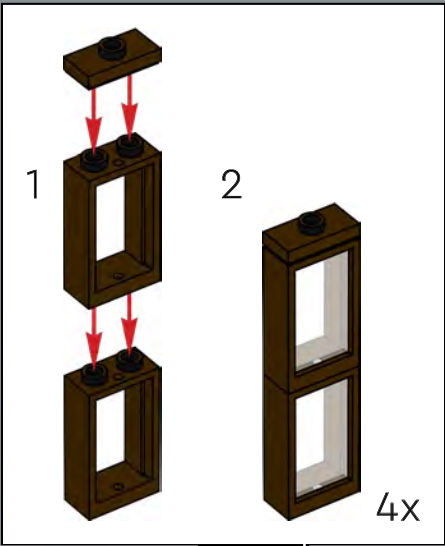

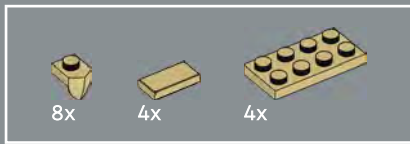

132

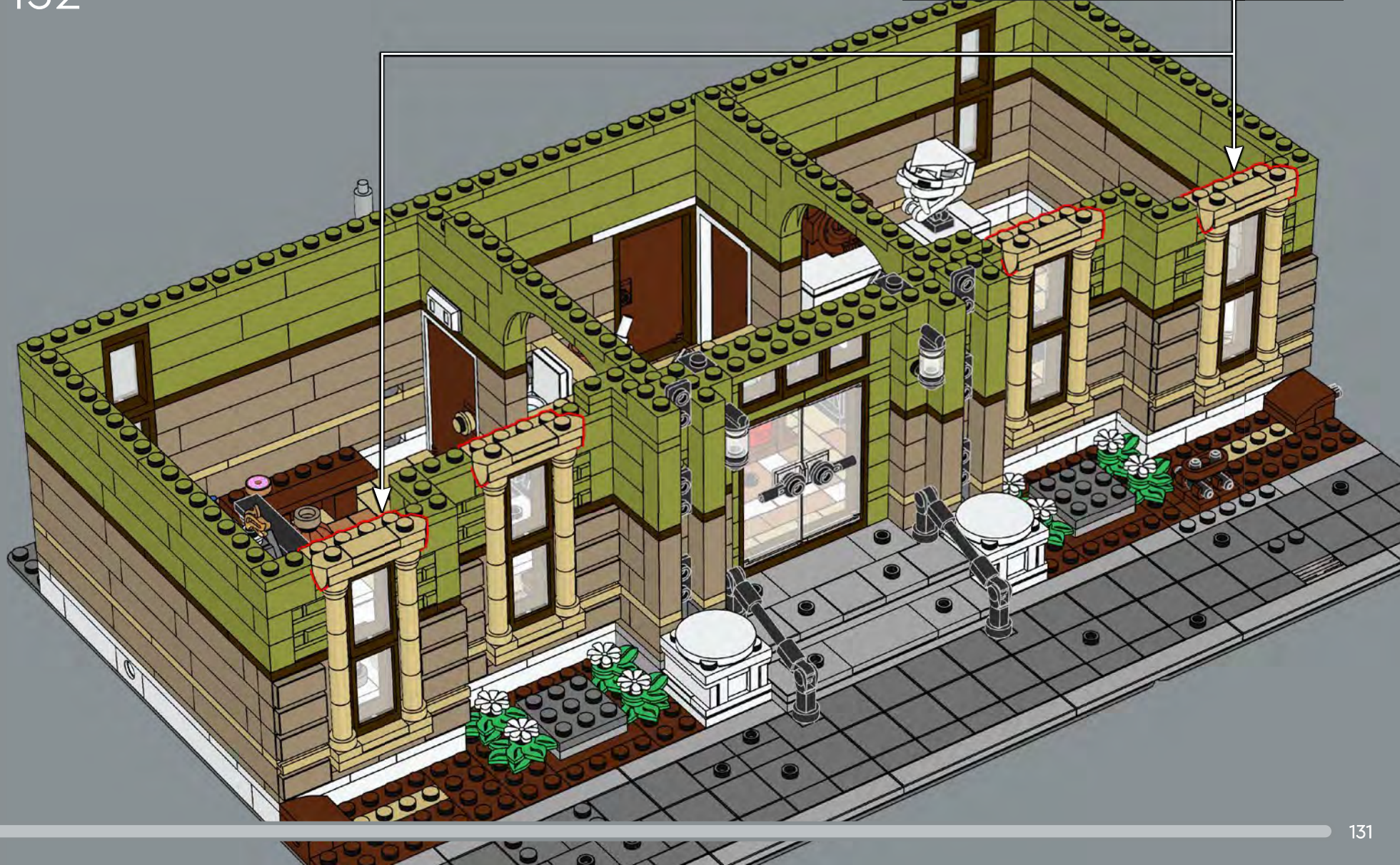
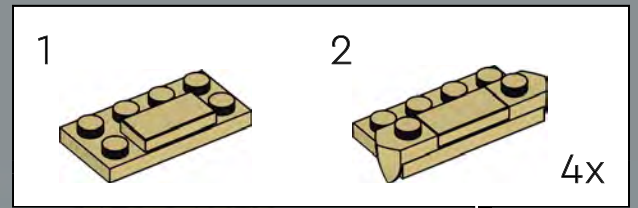

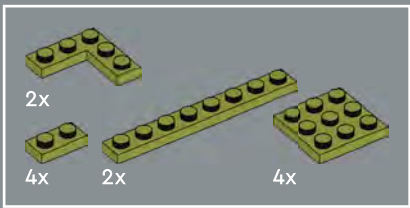

133



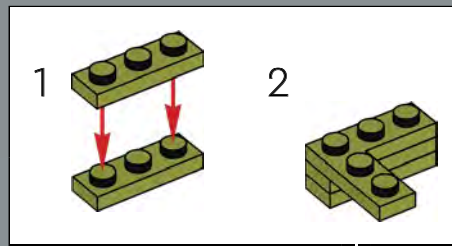
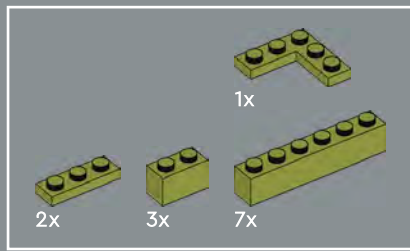

134



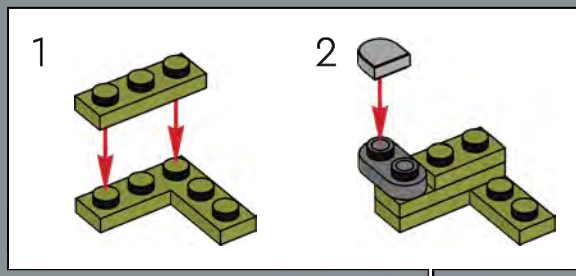
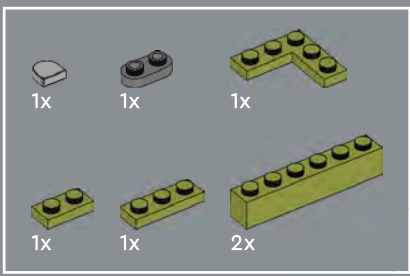

135



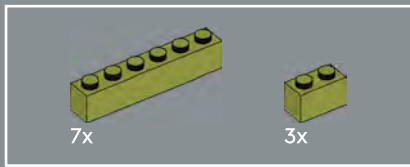

136





137



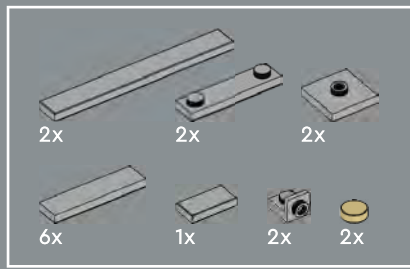

138



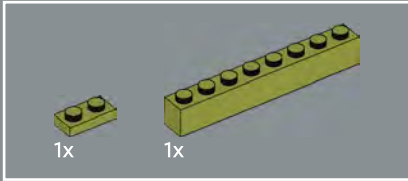
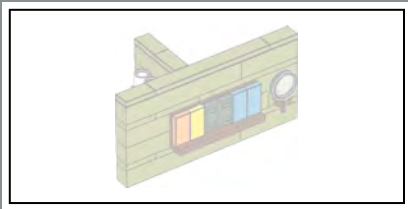

139

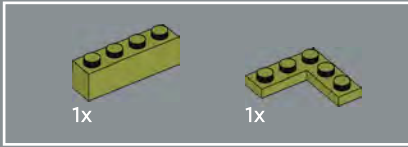
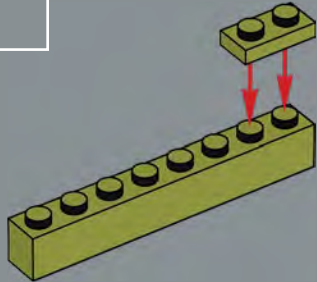

140

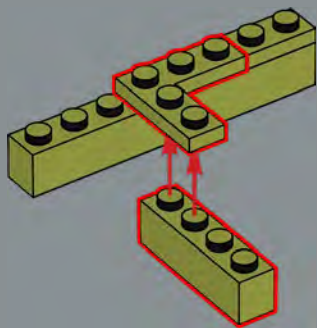

141

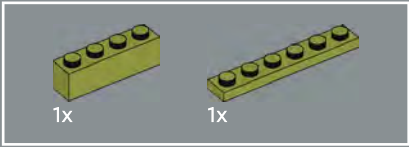
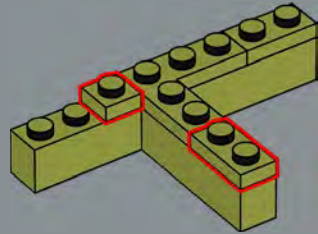

142

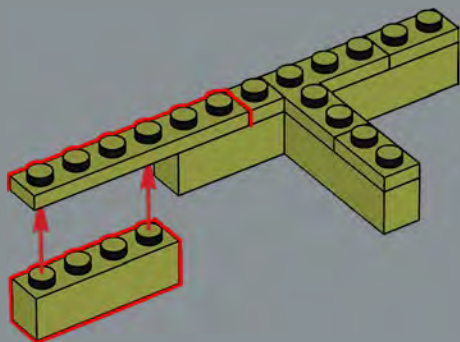



143

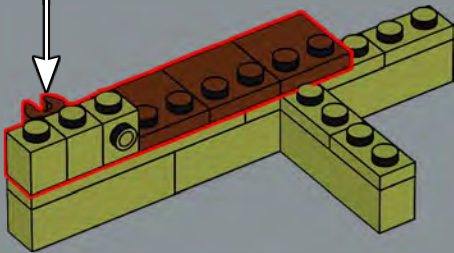
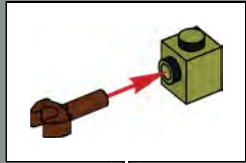

144

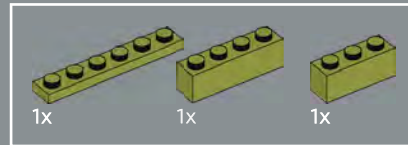
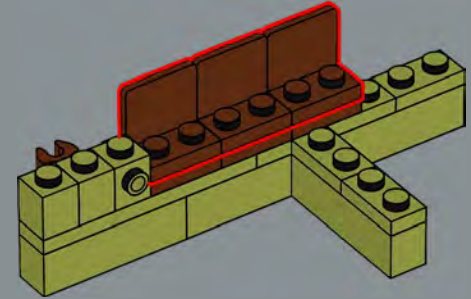

145

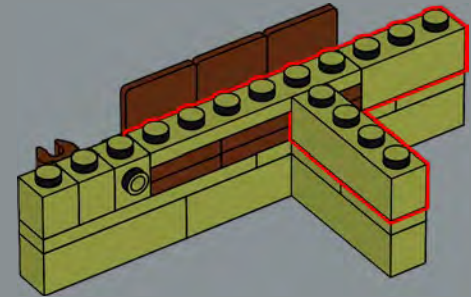

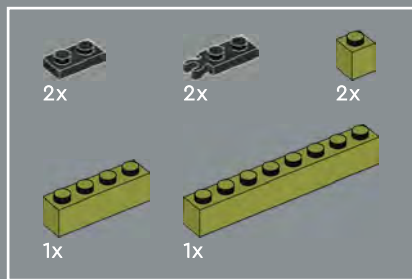

146

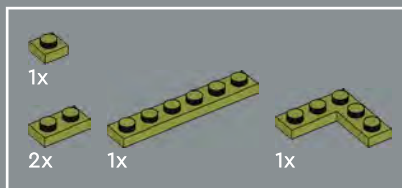
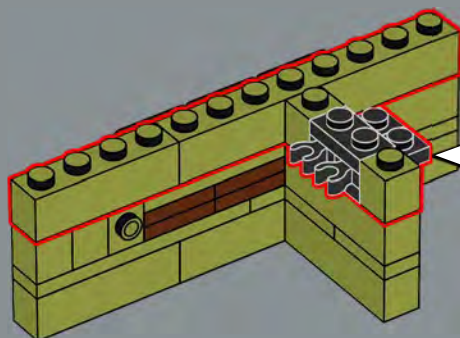
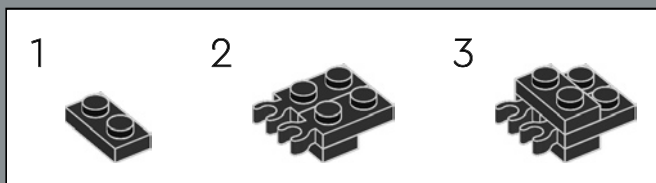

147

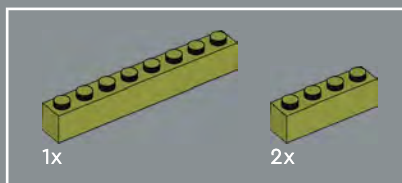
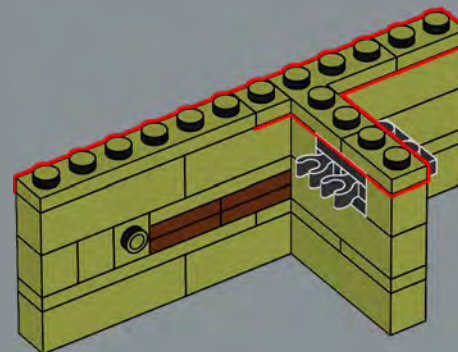

148

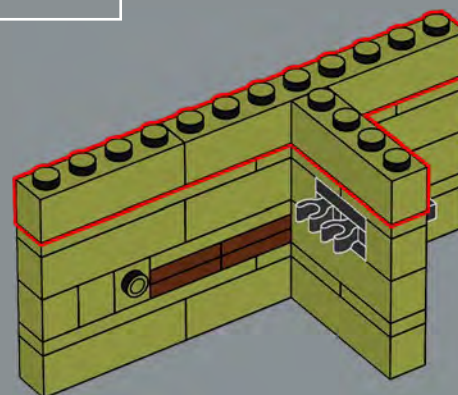

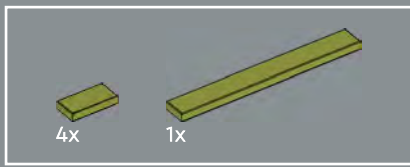

149

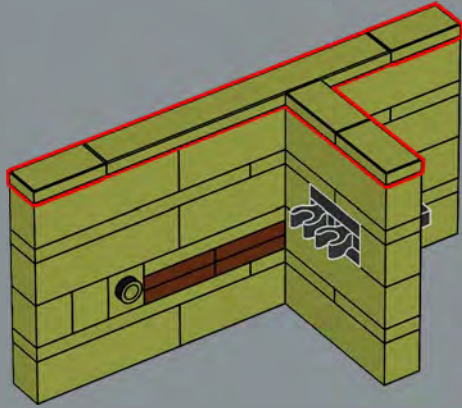

150

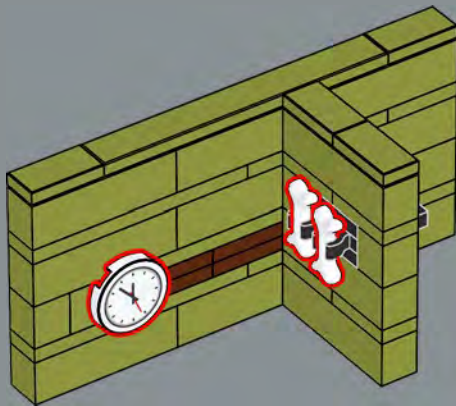

151

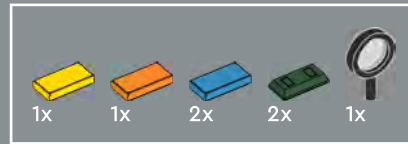
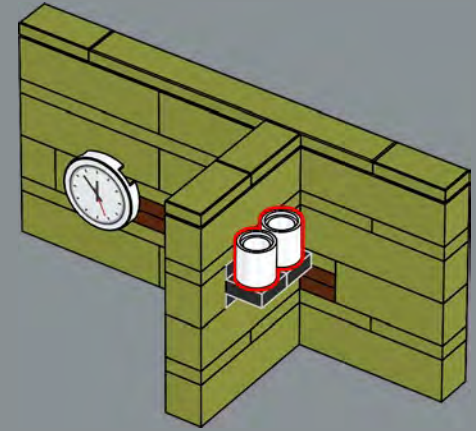

152

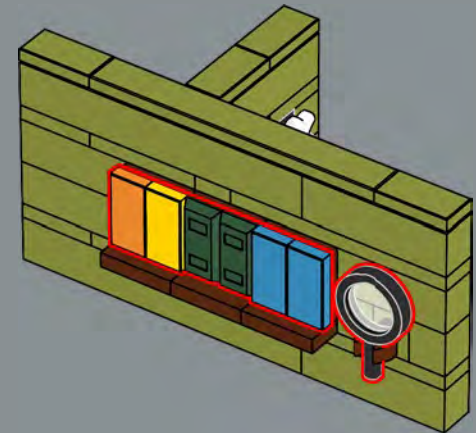



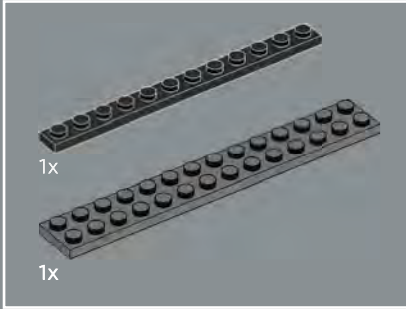
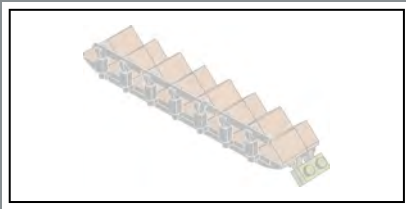

154

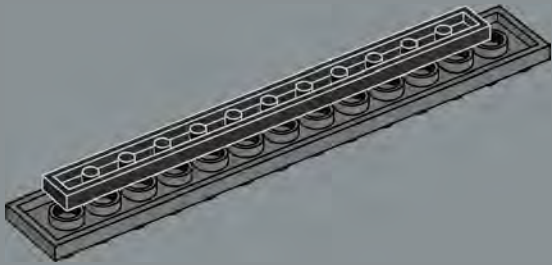

155

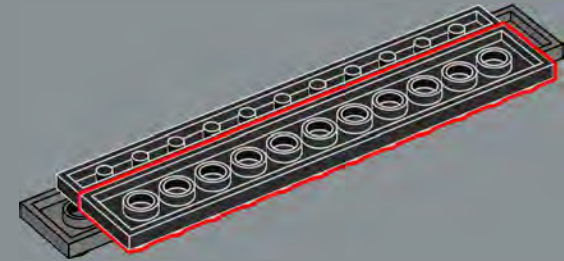

156

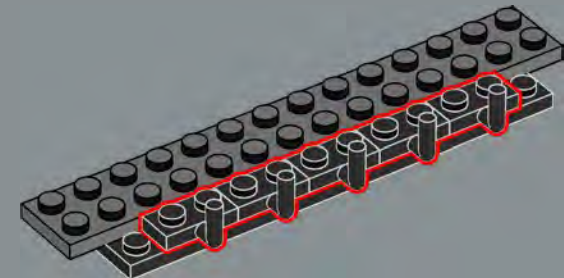



157

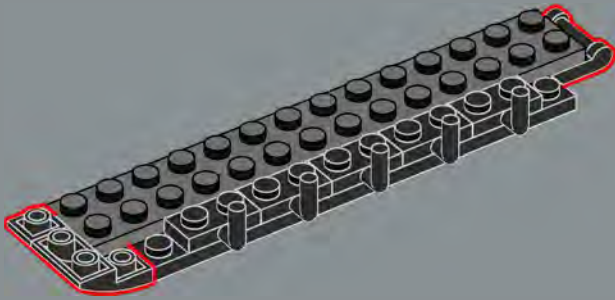

158

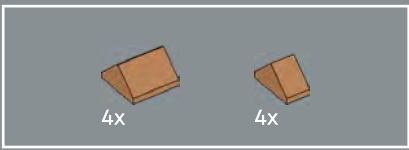
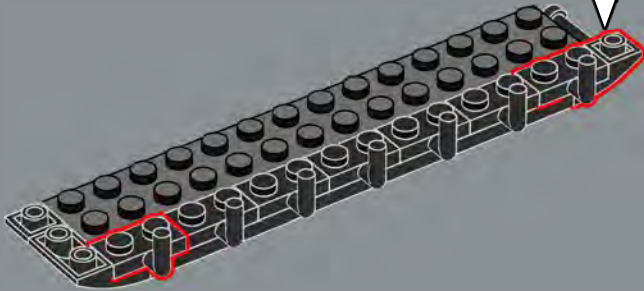
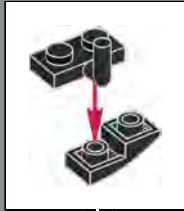

159

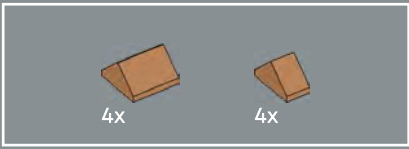
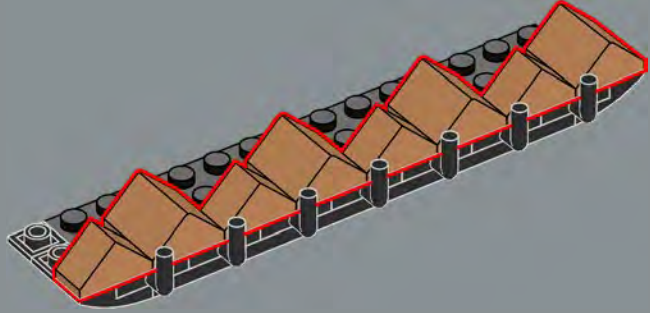

160



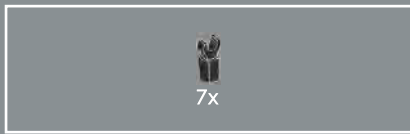

161

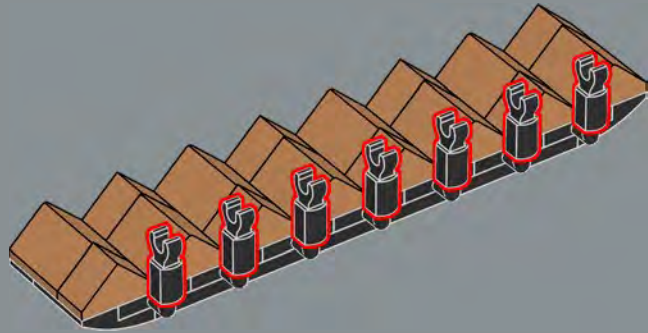

162

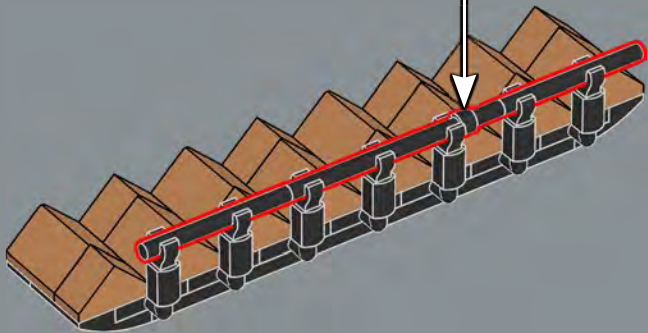

163

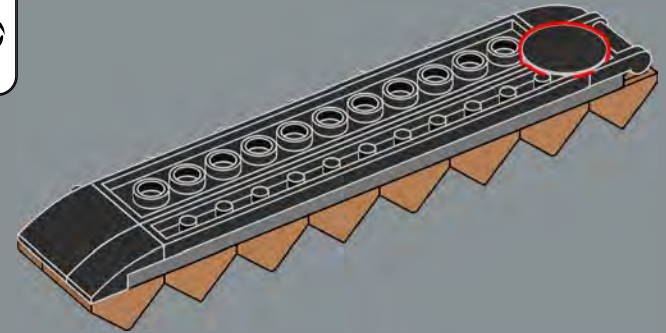

164

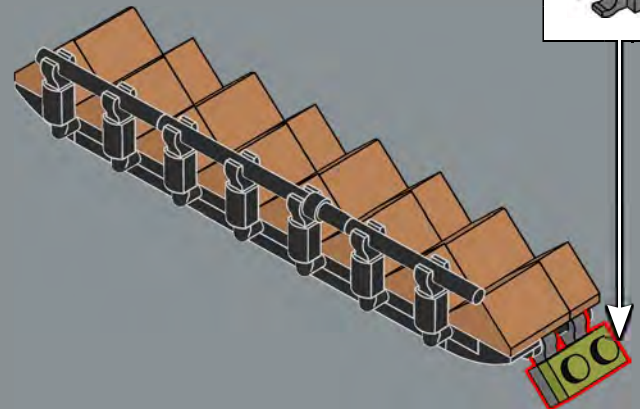
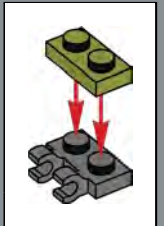



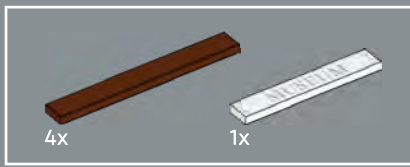

166



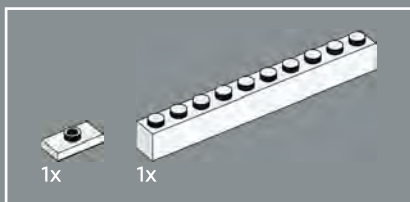
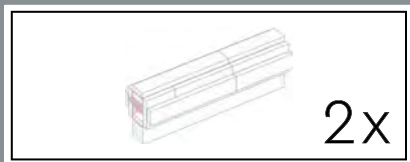

167

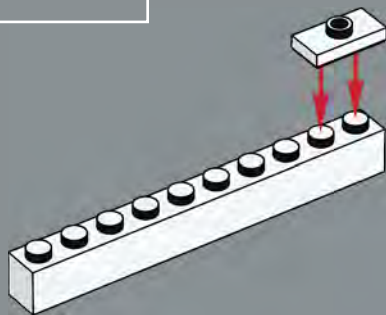

168

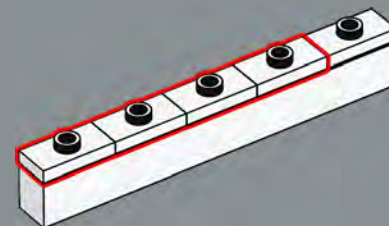

169

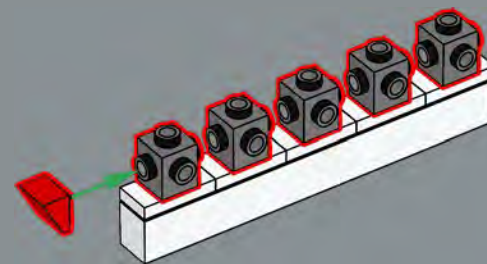

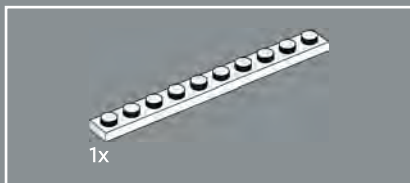

170

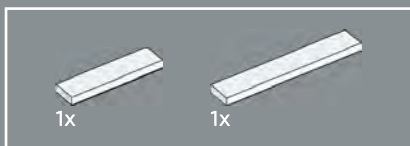
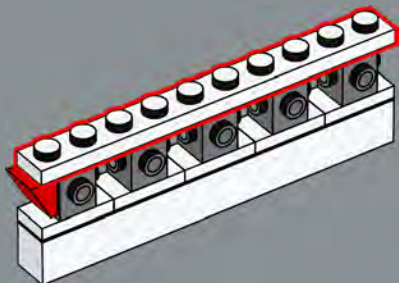

171

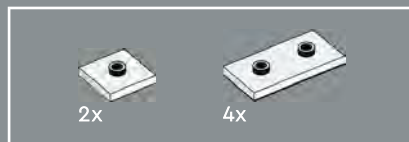
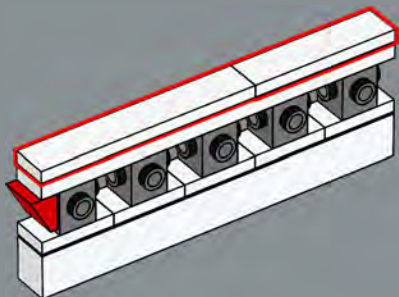

172

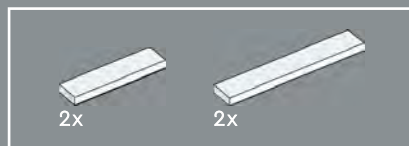
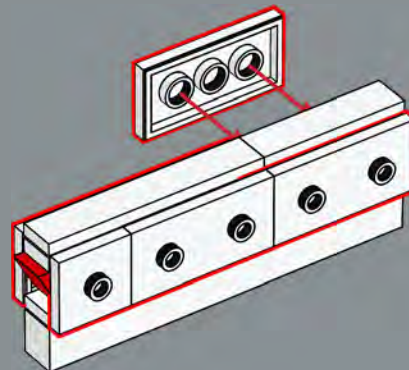

173

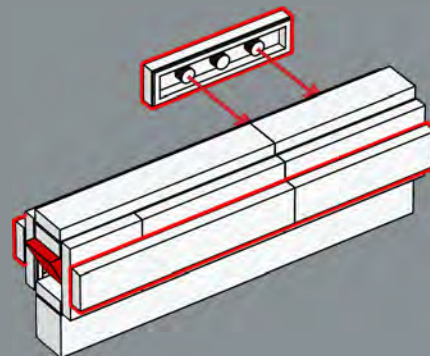

2x



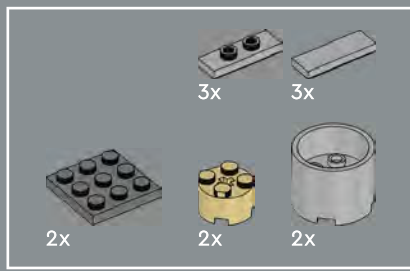

175

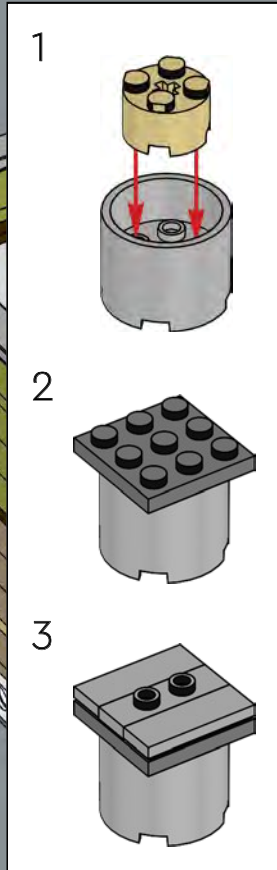



176



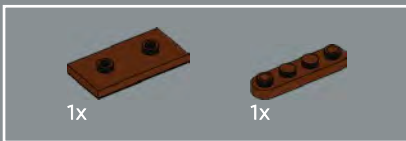

177

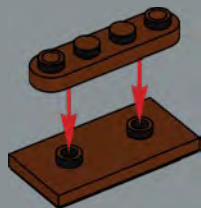

178



179



180



181

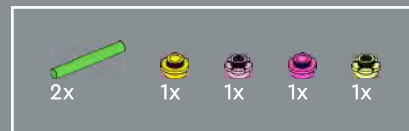
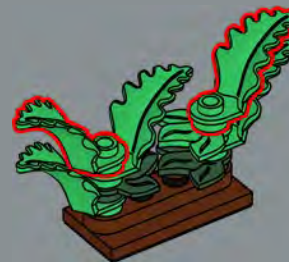

182

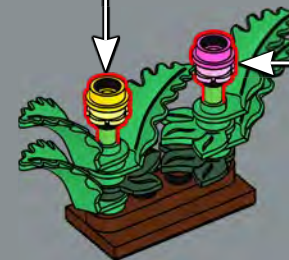
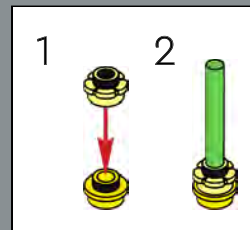
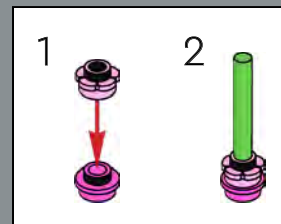



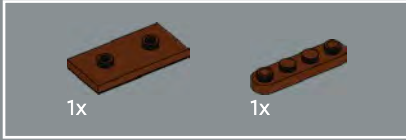

184

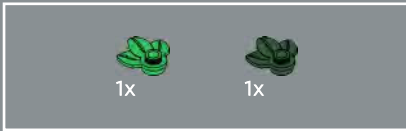
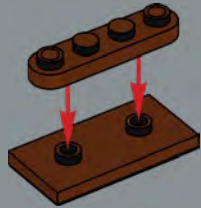

185



186



187



188



189

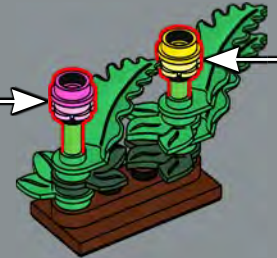
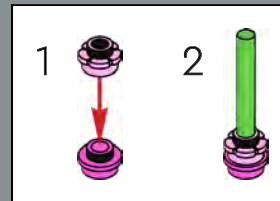
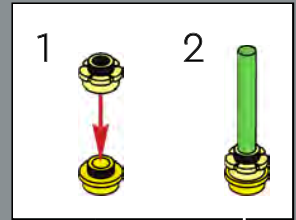

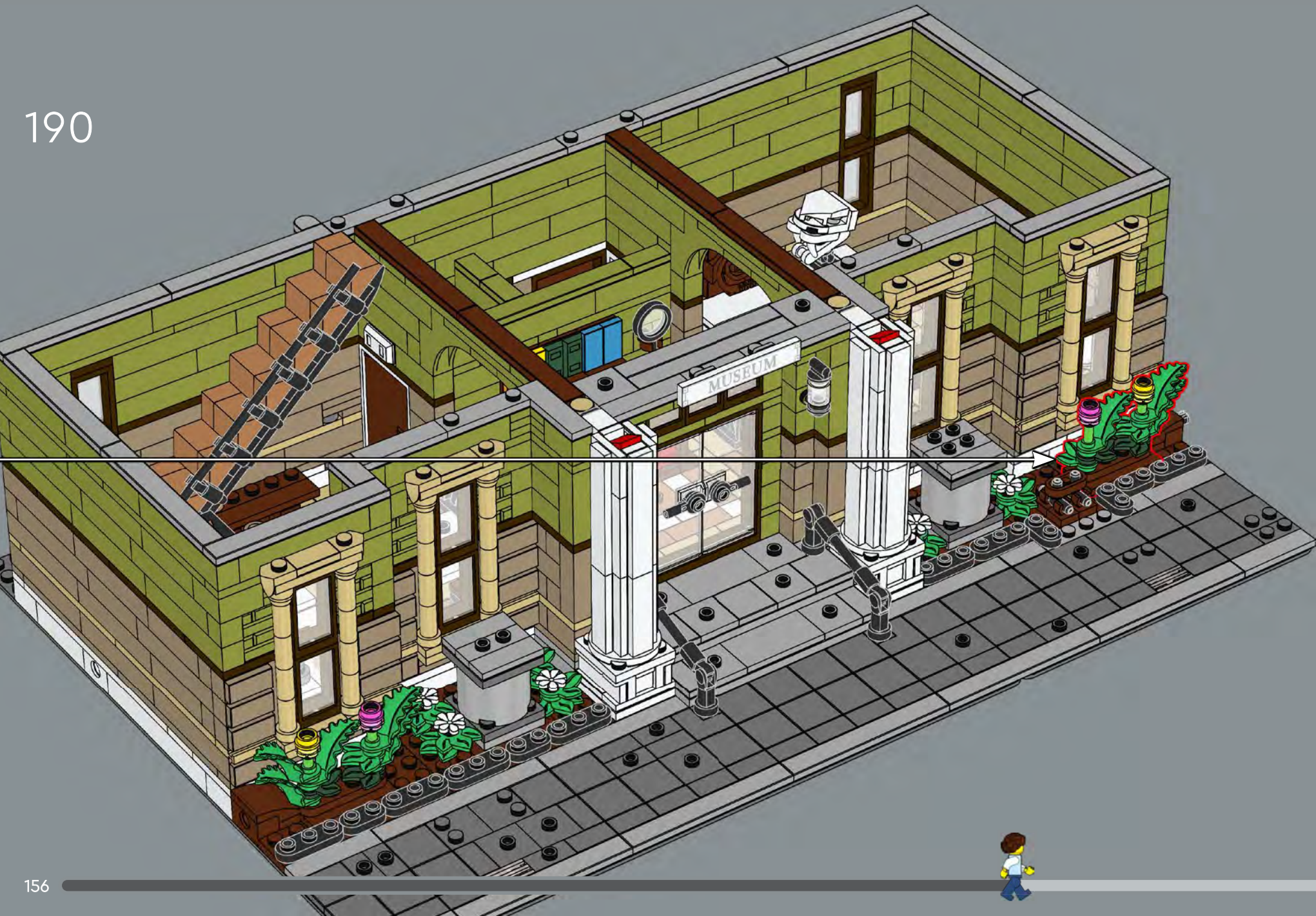



191

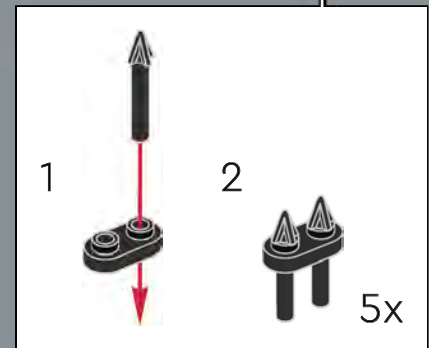
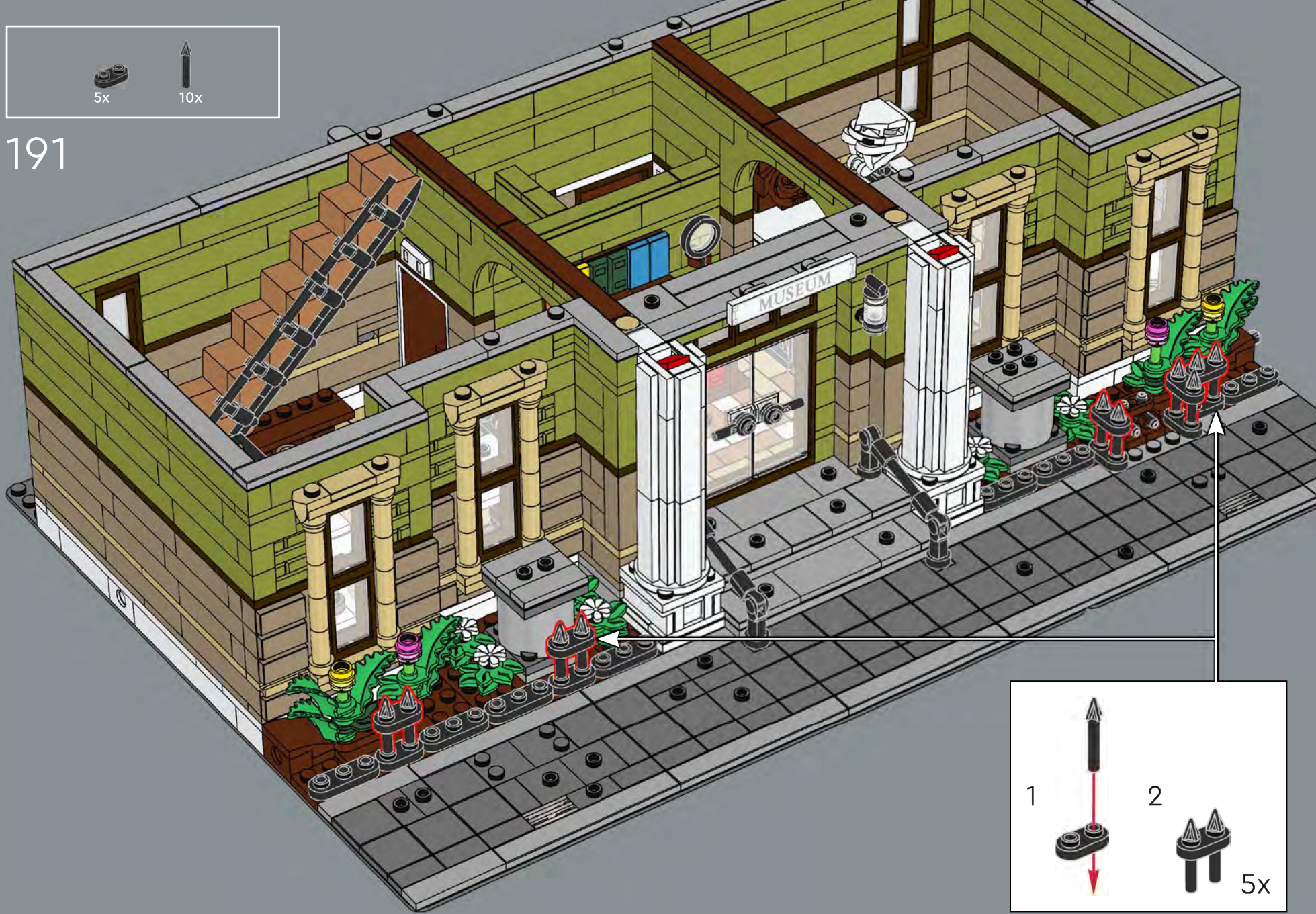



192

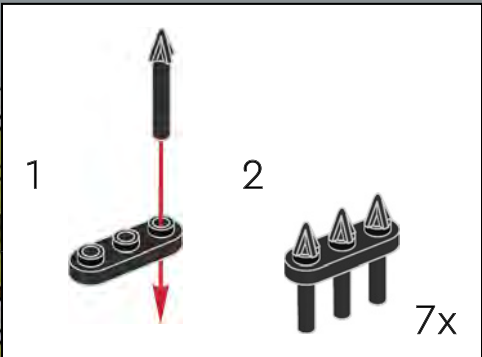

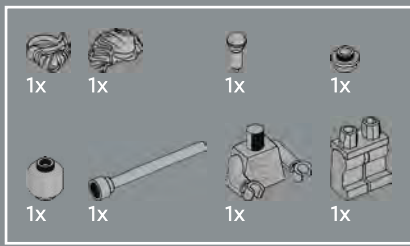

193

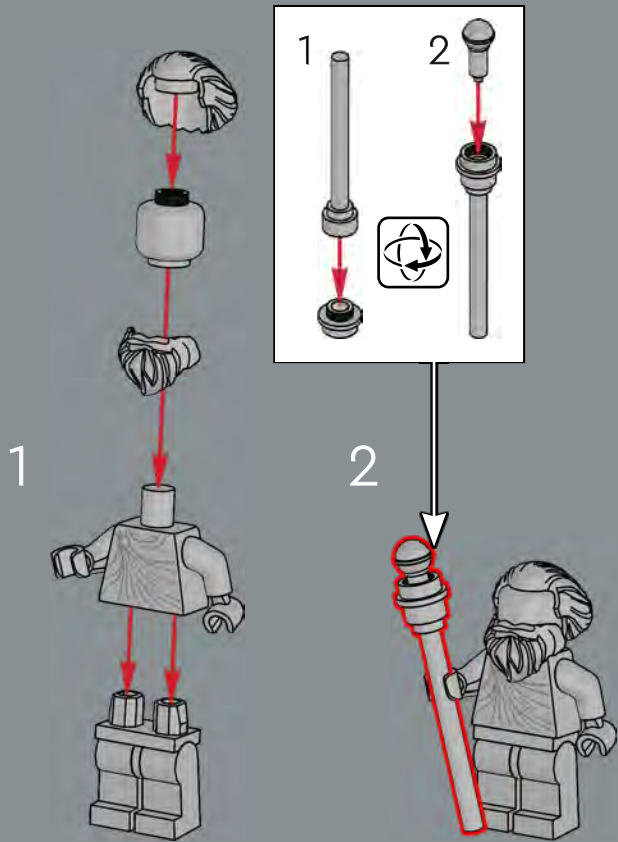

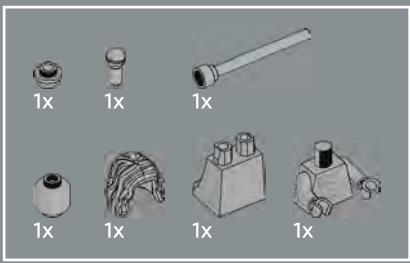

194

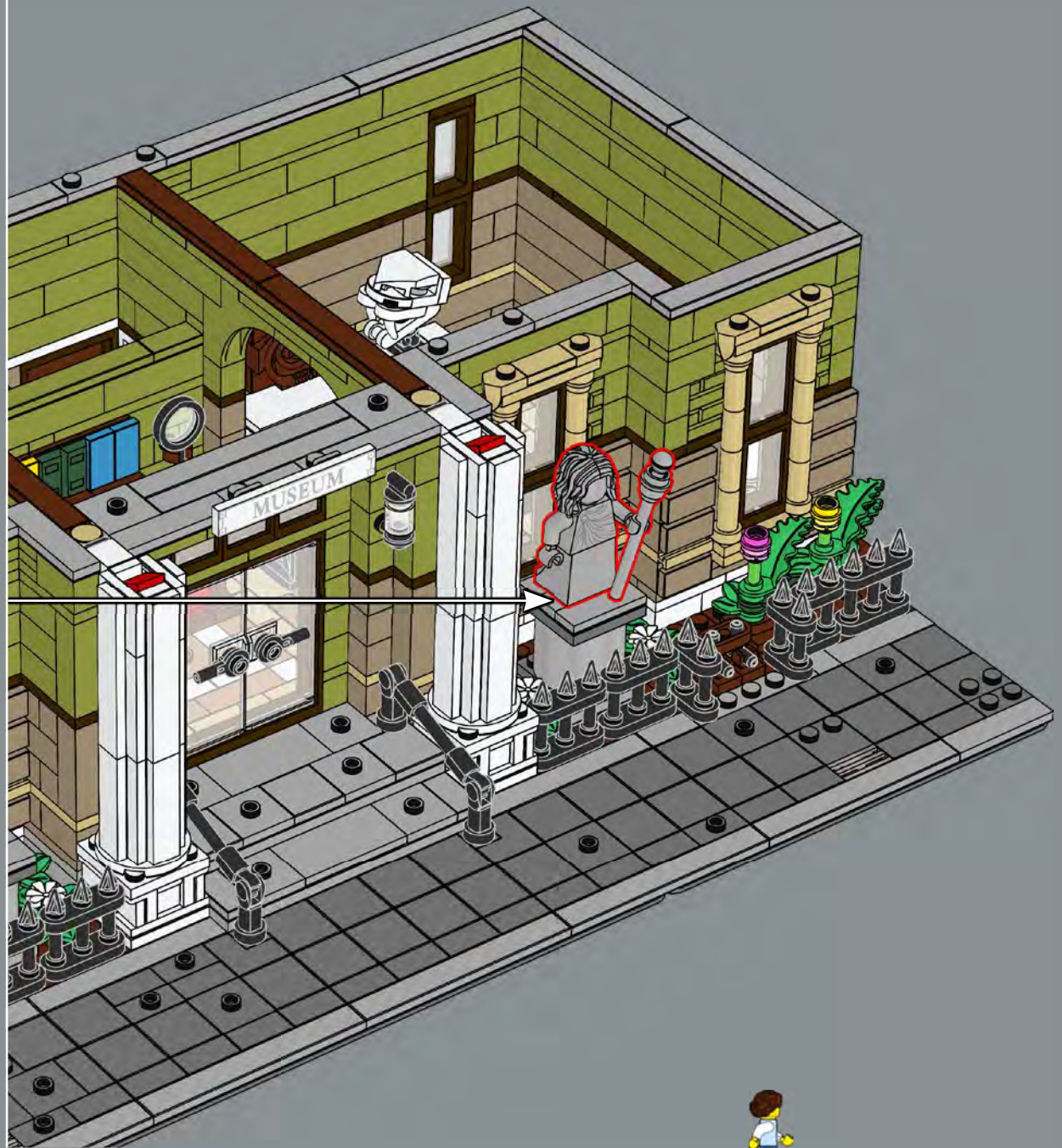
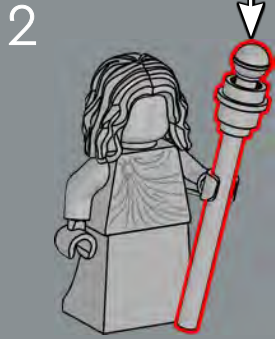
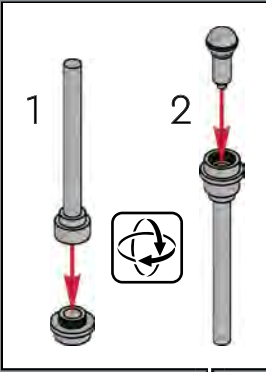
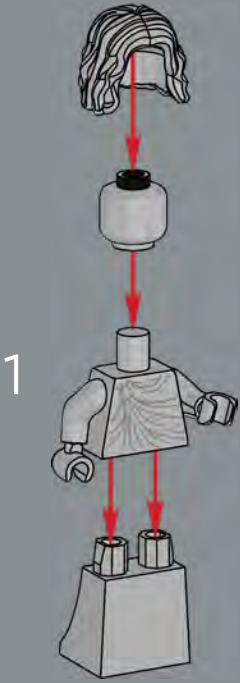

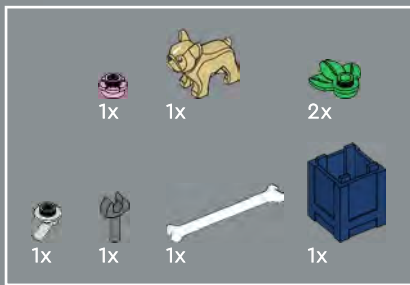

195

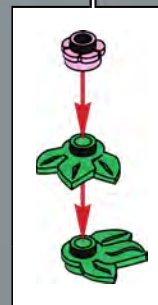
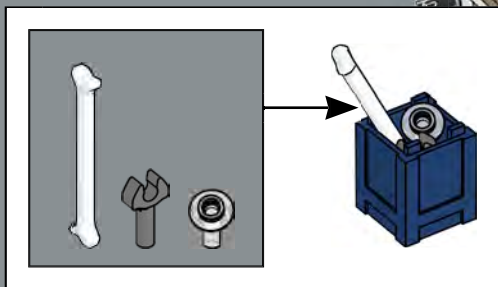

Even the tiniest crack in the pavement allows new life to find a way through.

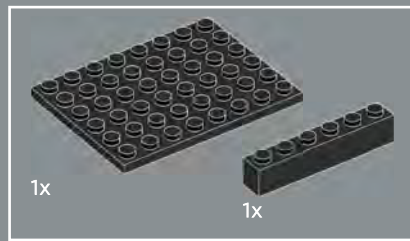

196

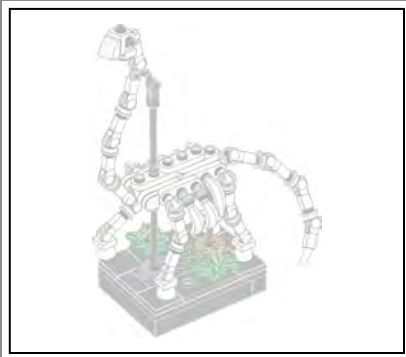
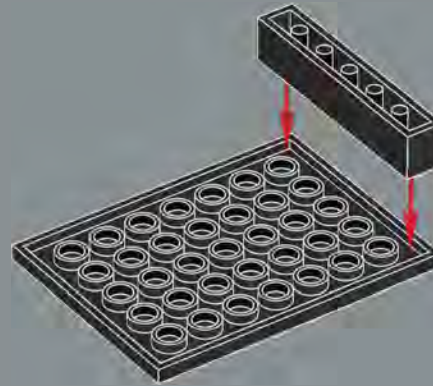

197

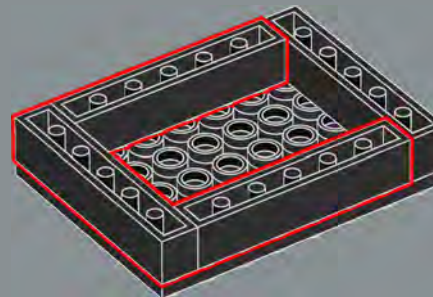

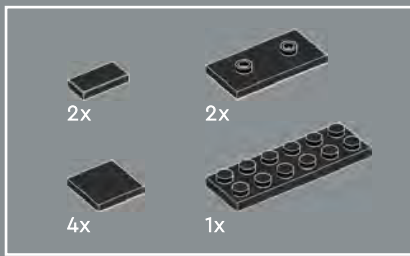

198

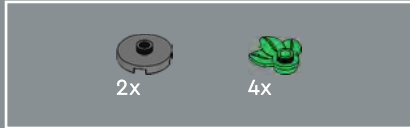
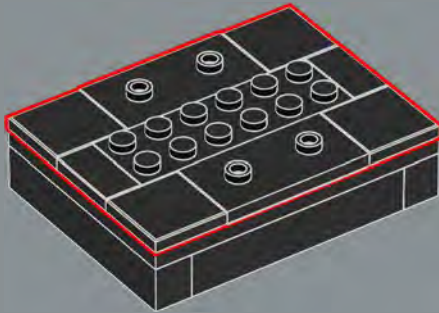

199

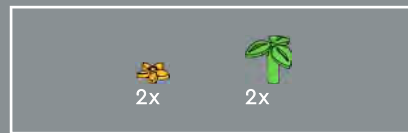
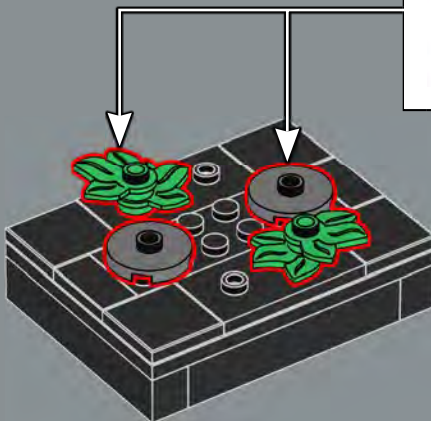
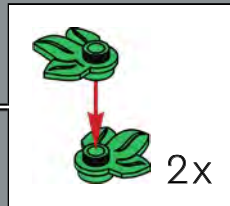

200

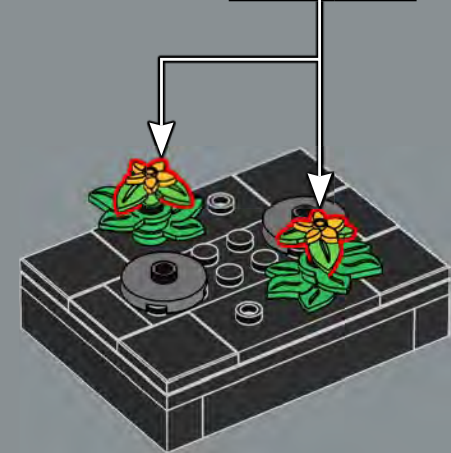
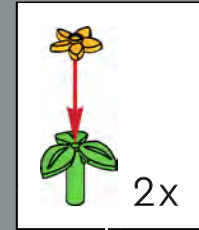

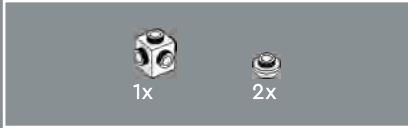
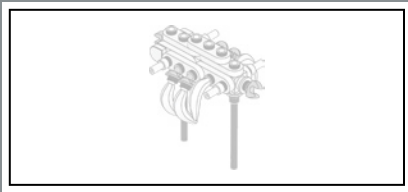

201



202



203



204



205

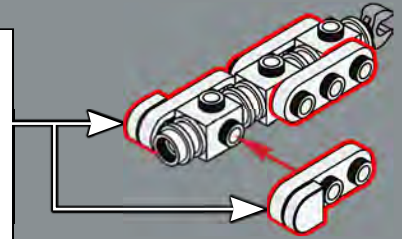
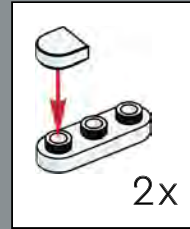

206

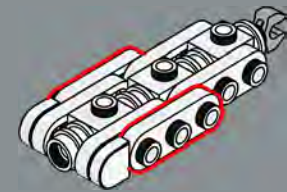



207

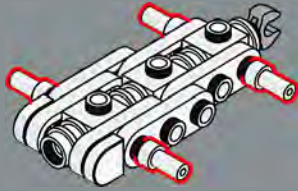

208

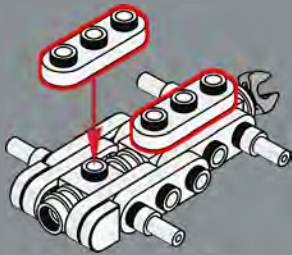

209



210

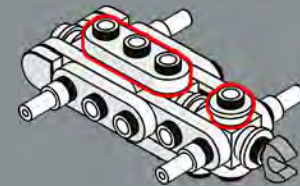



211

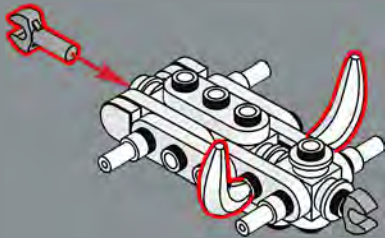

212

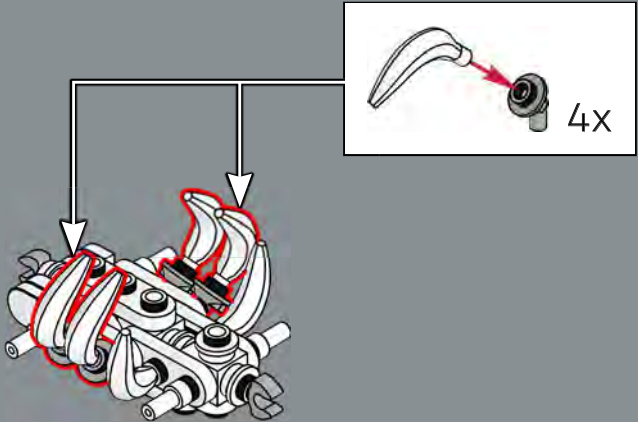

213

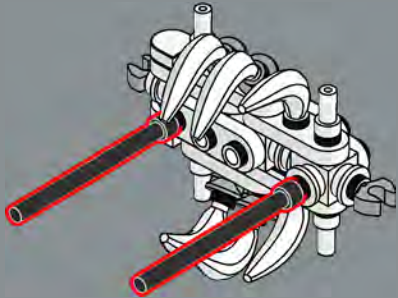

214



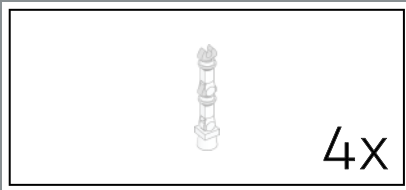

215

1

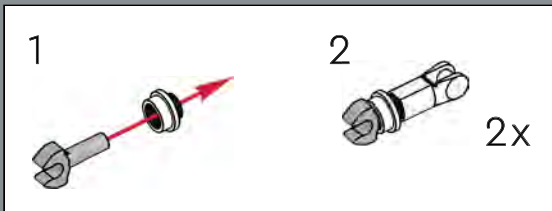

2

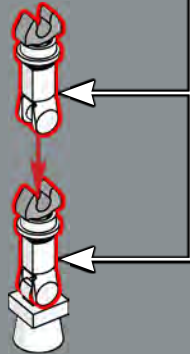

4x

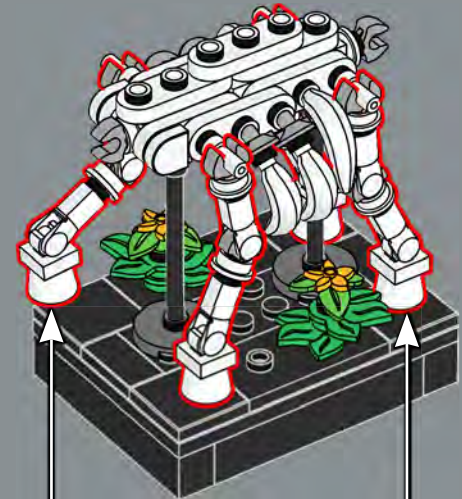



216

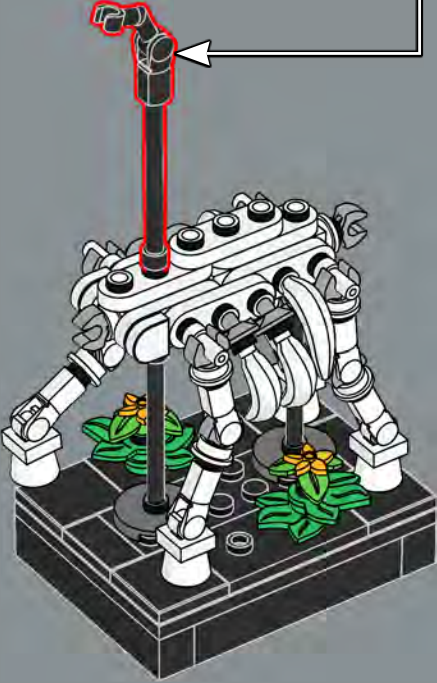
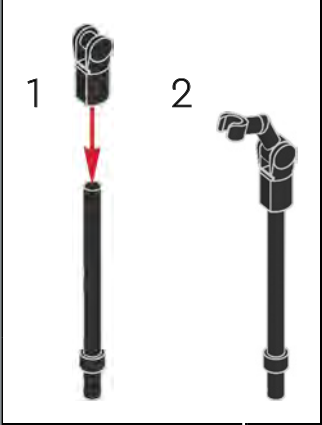

217

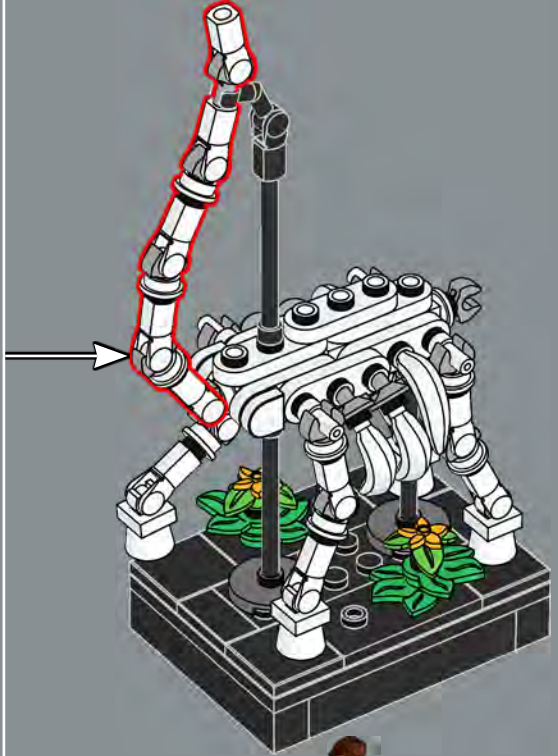
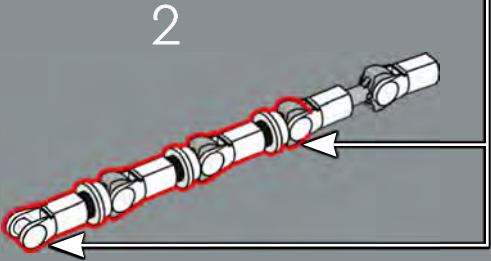
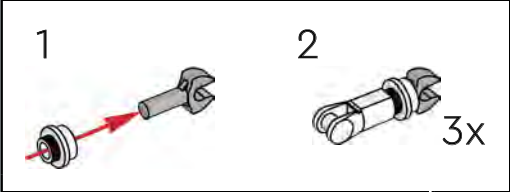
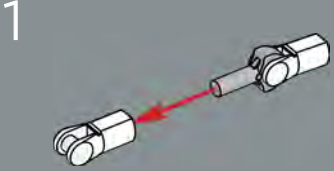



218

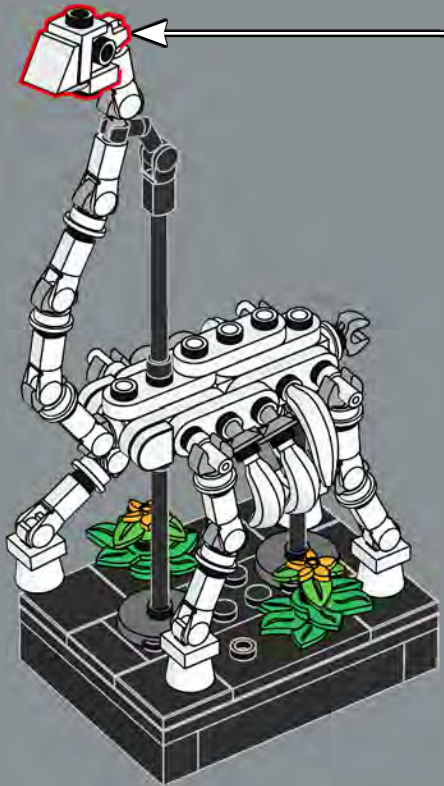
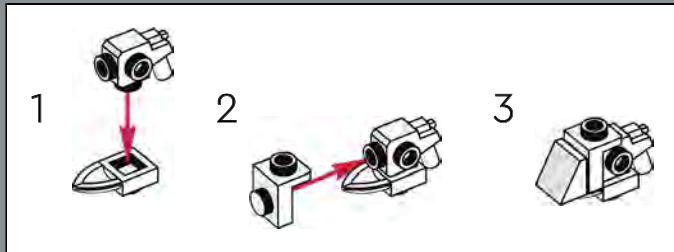

219

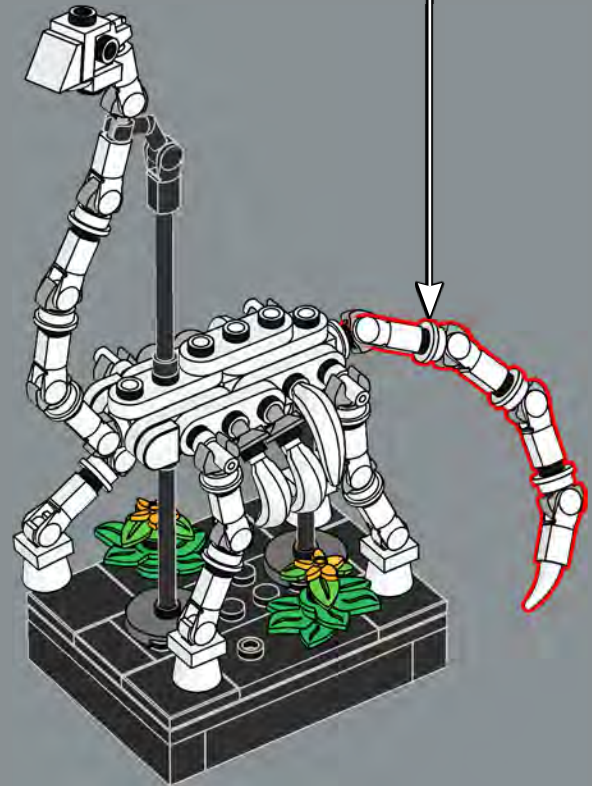
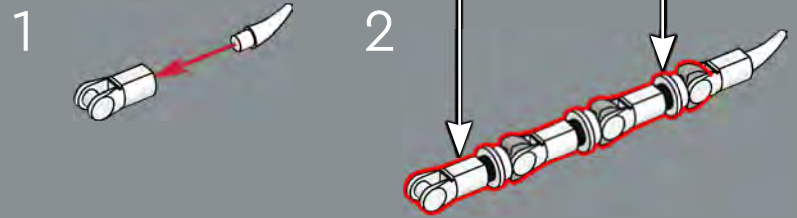
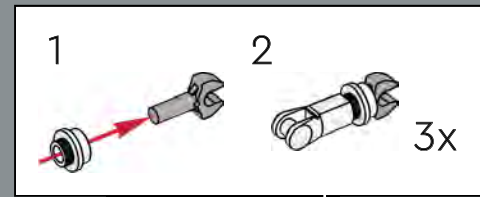



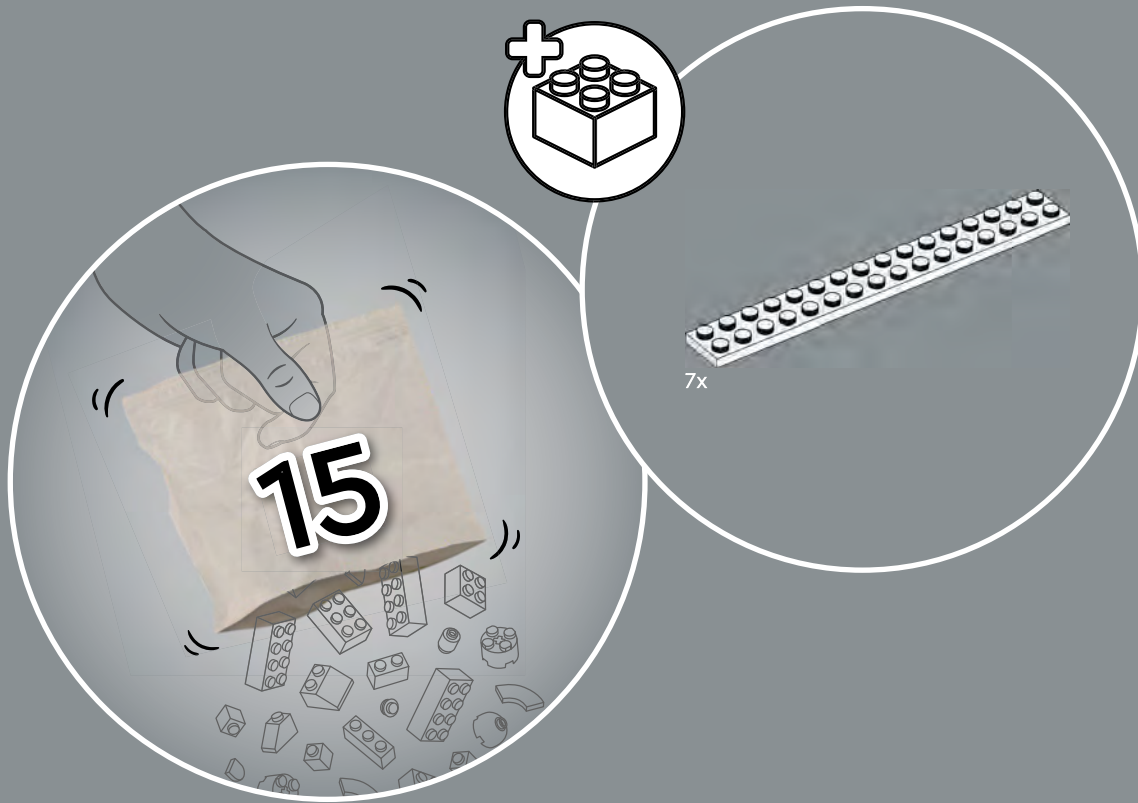

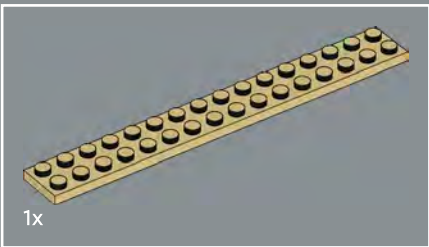

221

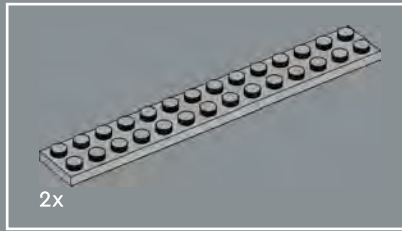
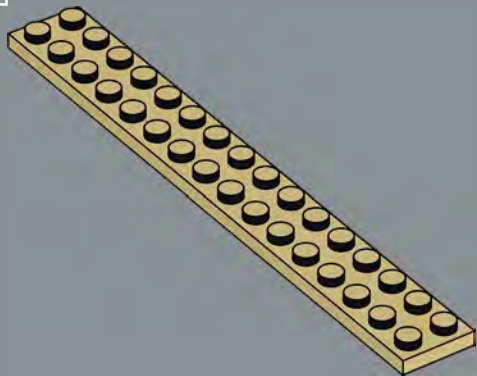

222

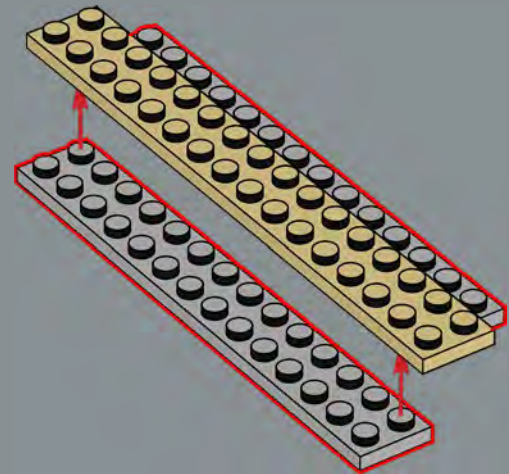

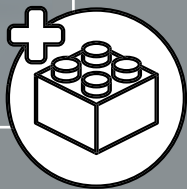
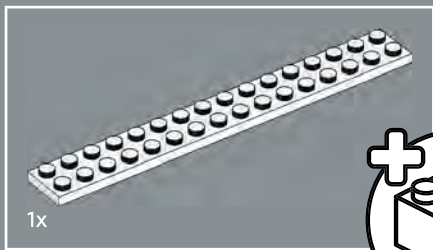

223

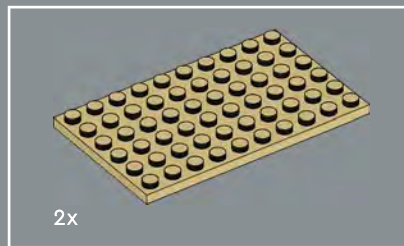
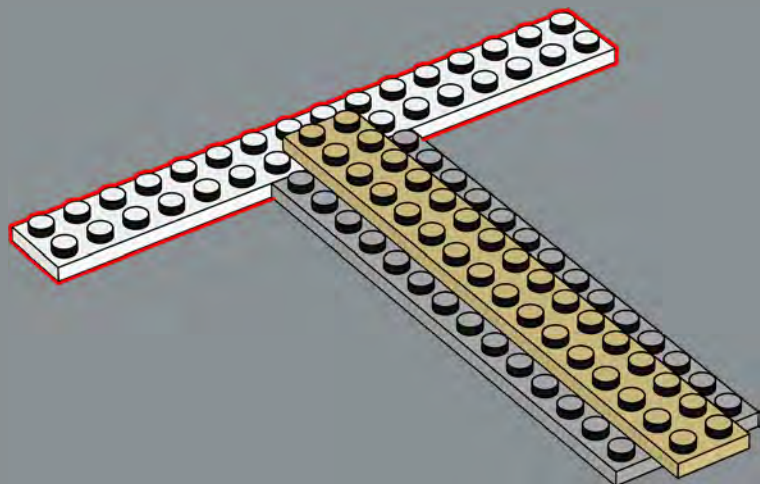

224

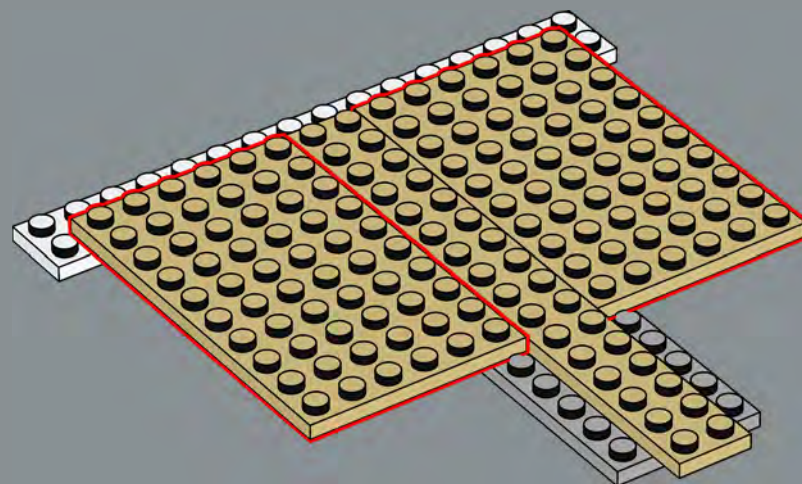

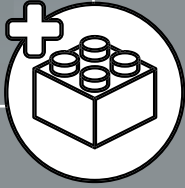
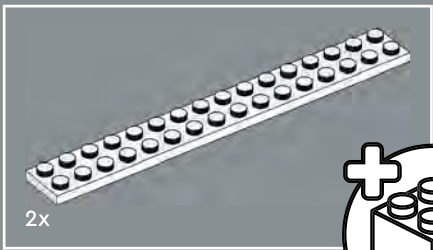

225

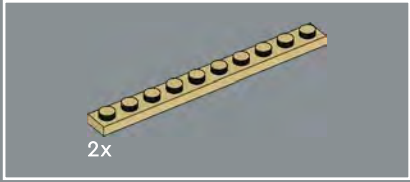
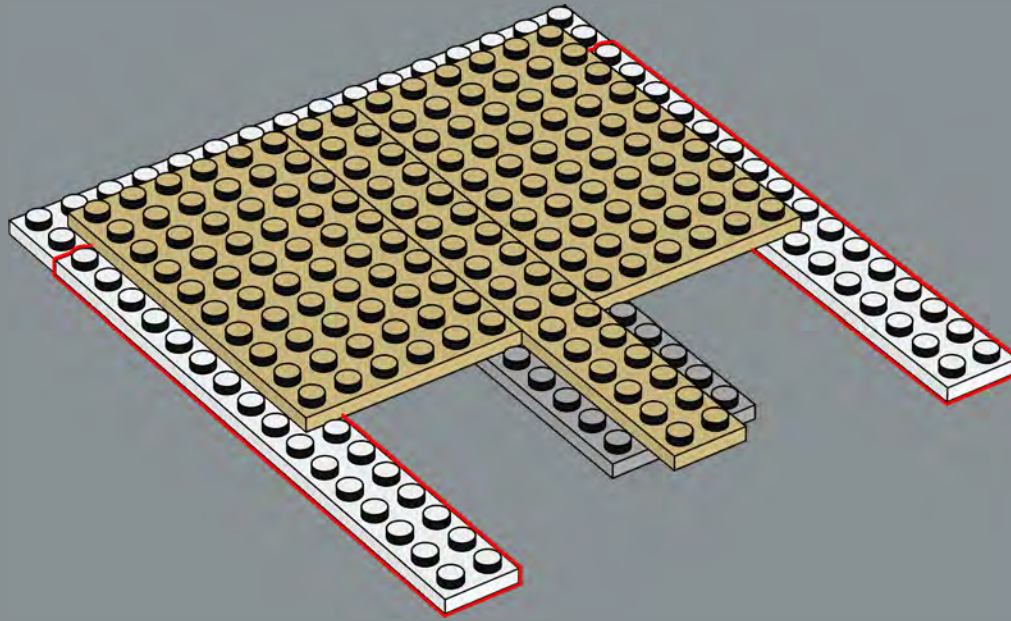

226

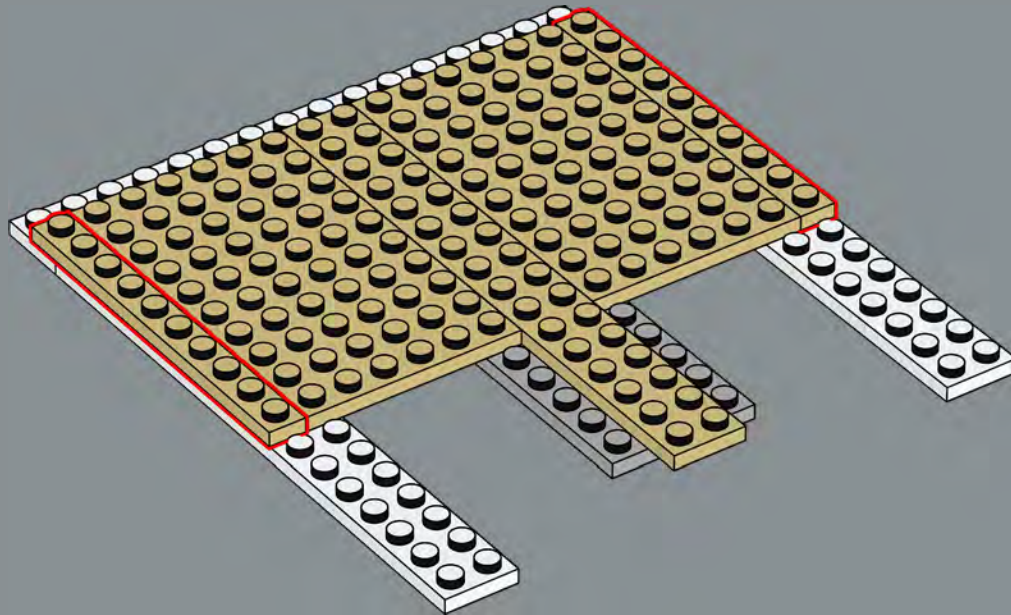

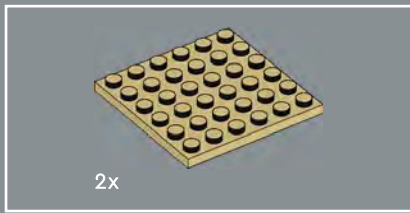

227

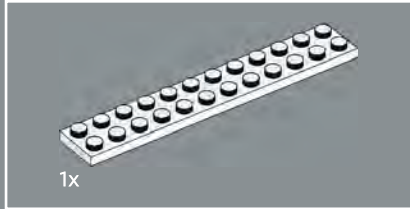
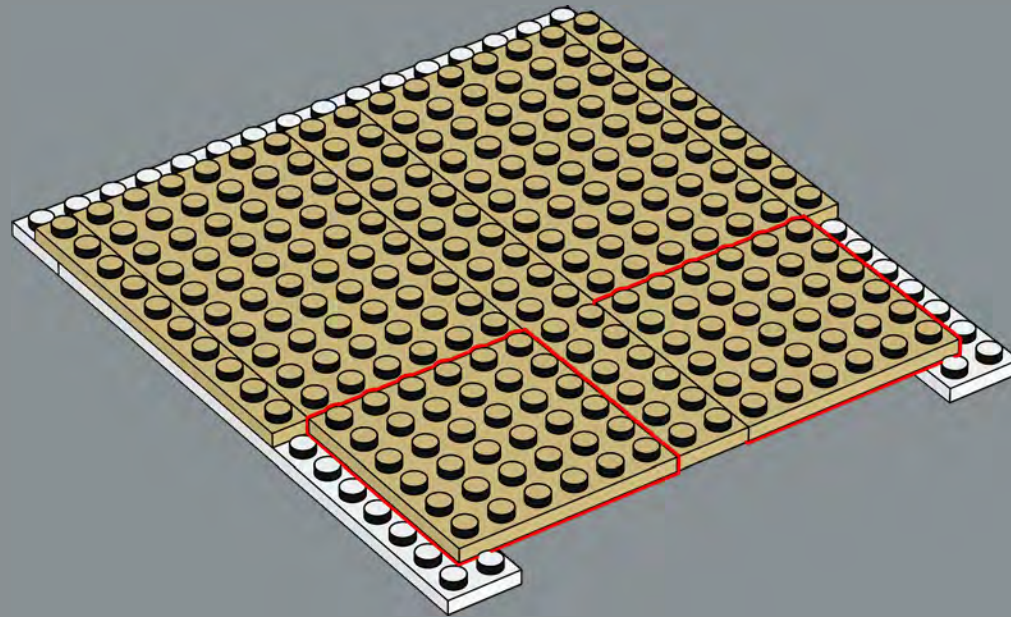

228

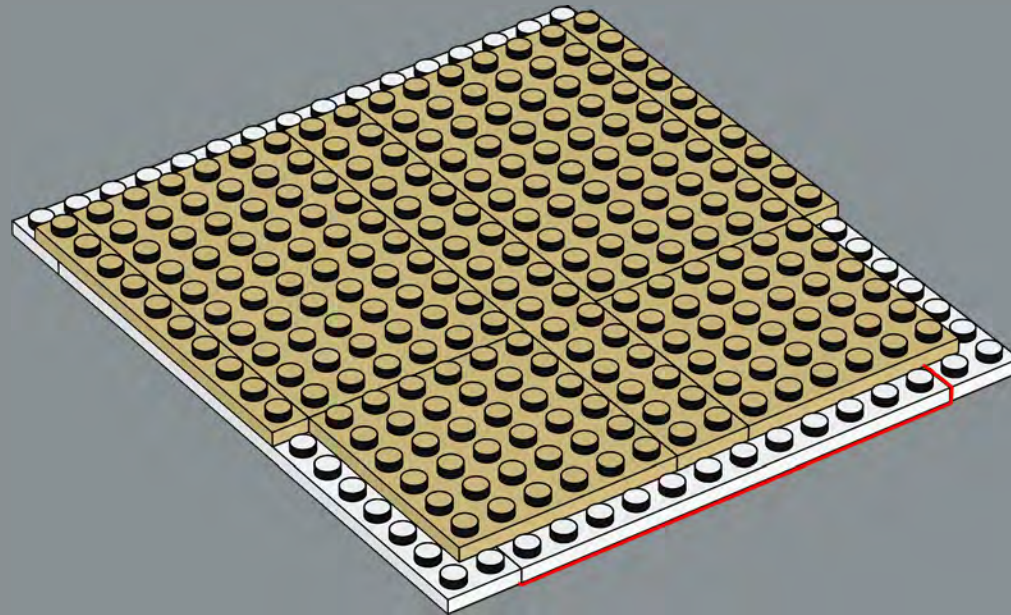

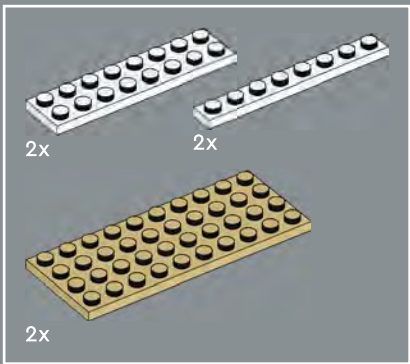

229

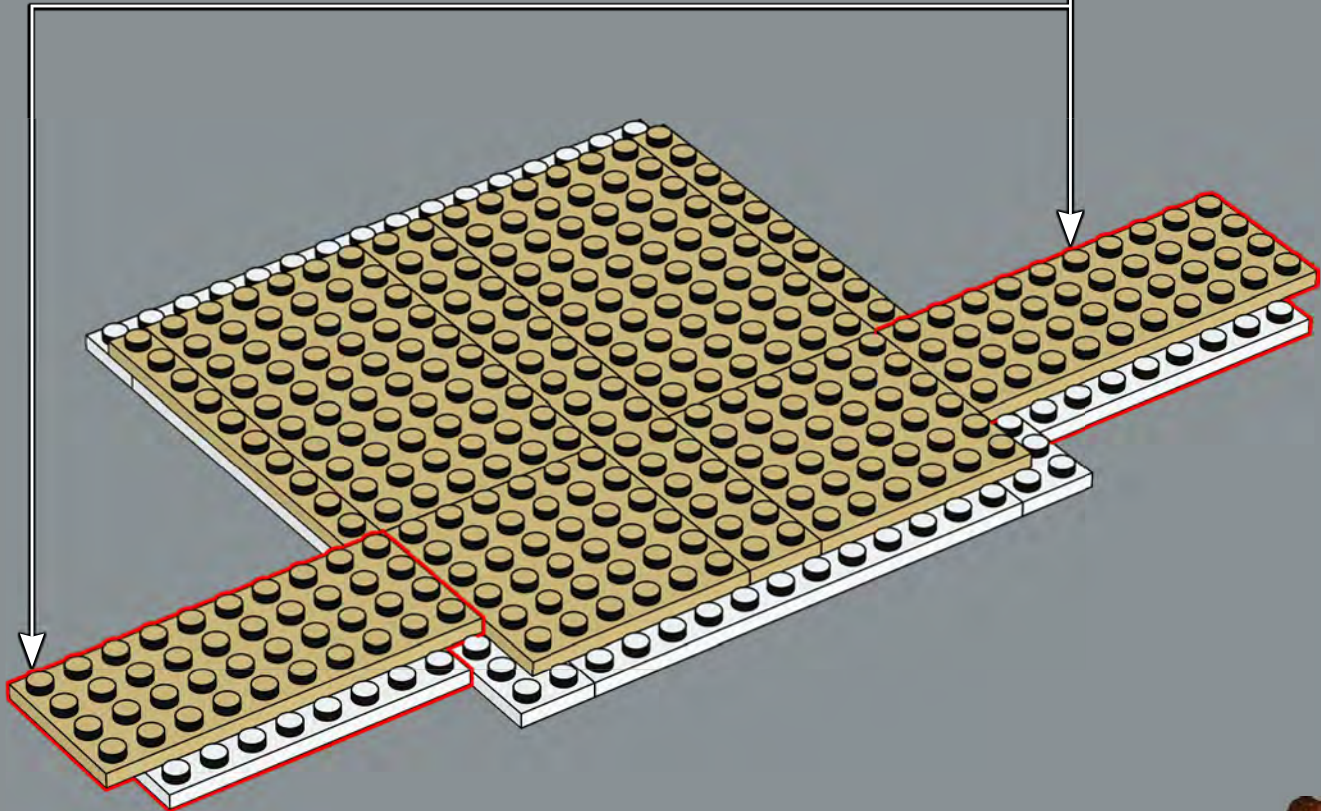
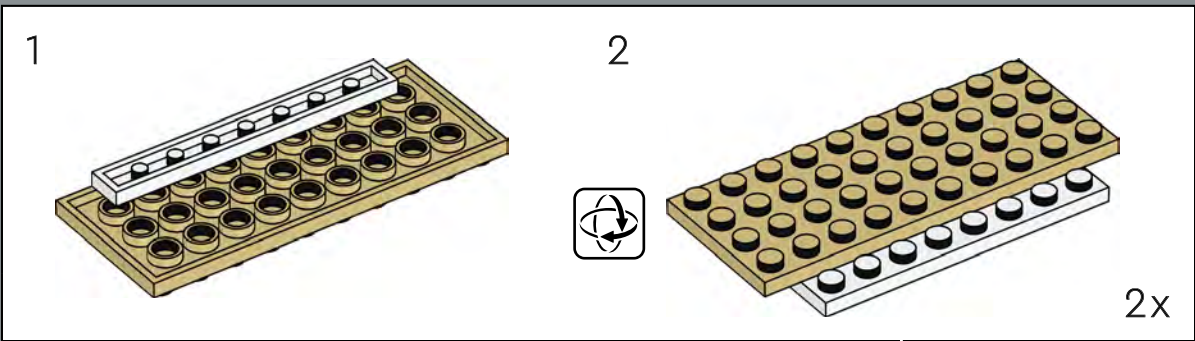

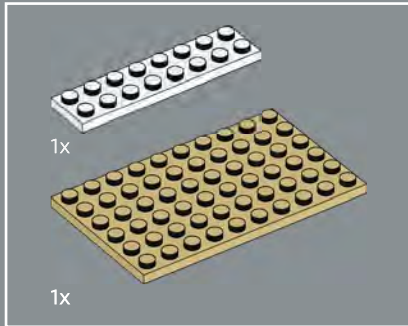
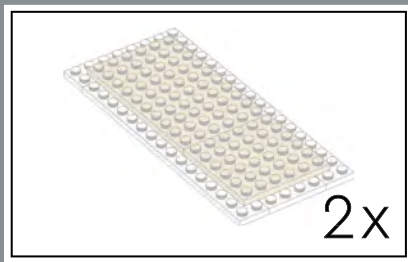

230

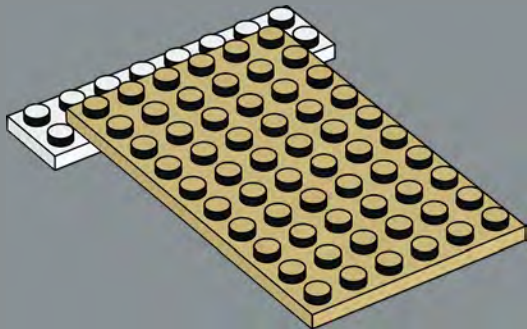

231

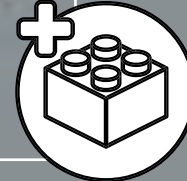
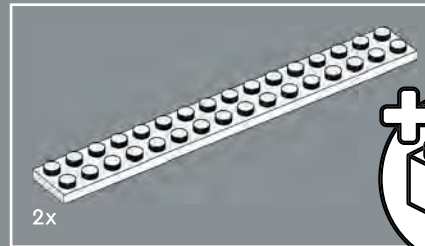
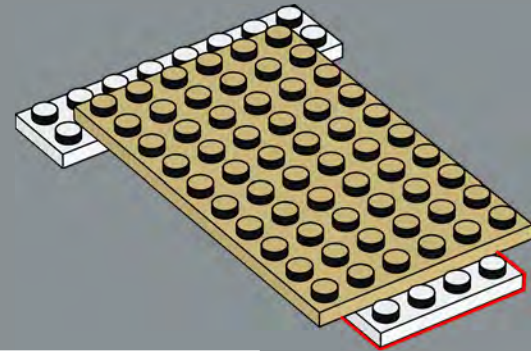

232

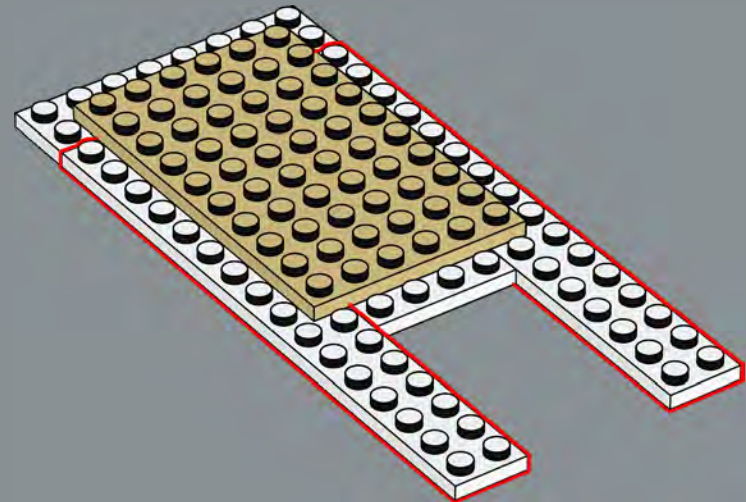

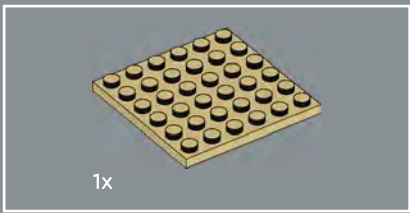

233

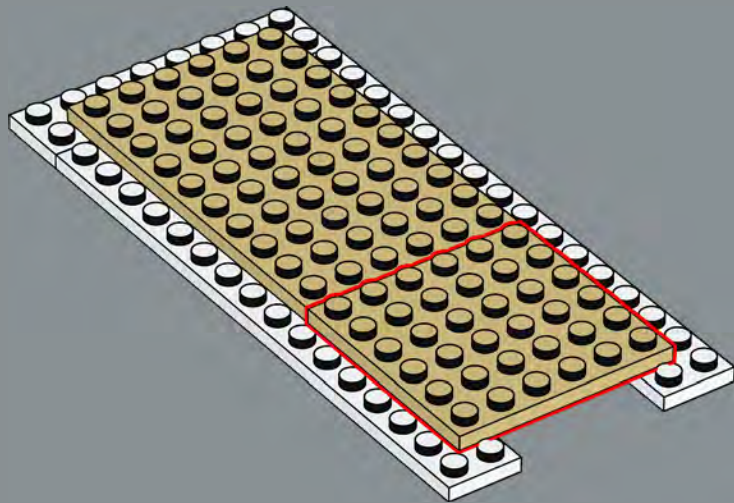

234

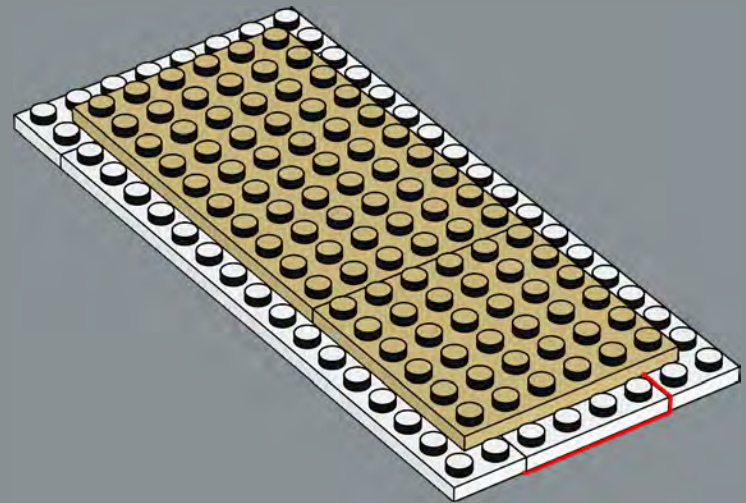

2x



235

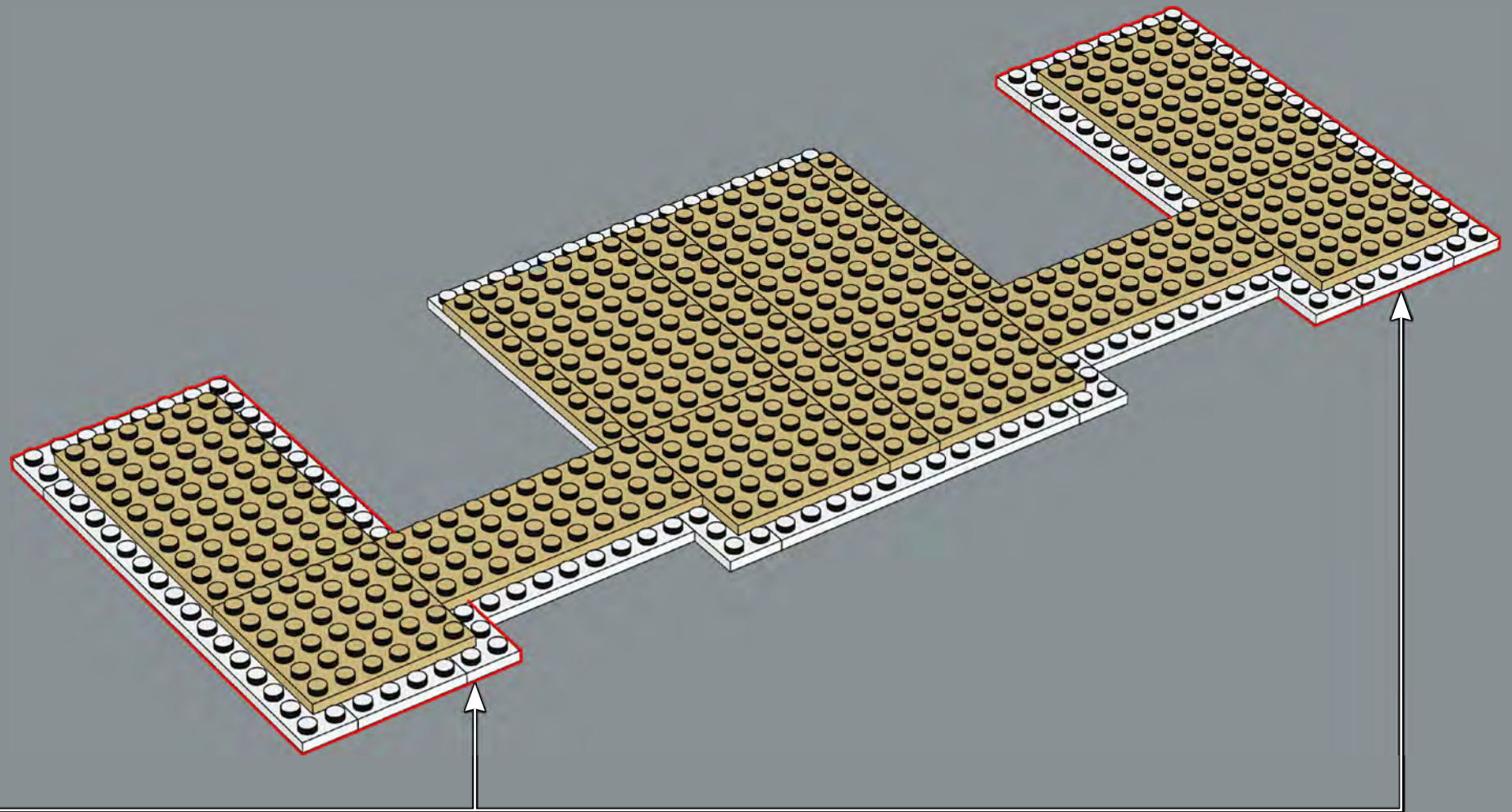

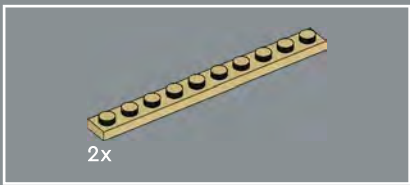

236

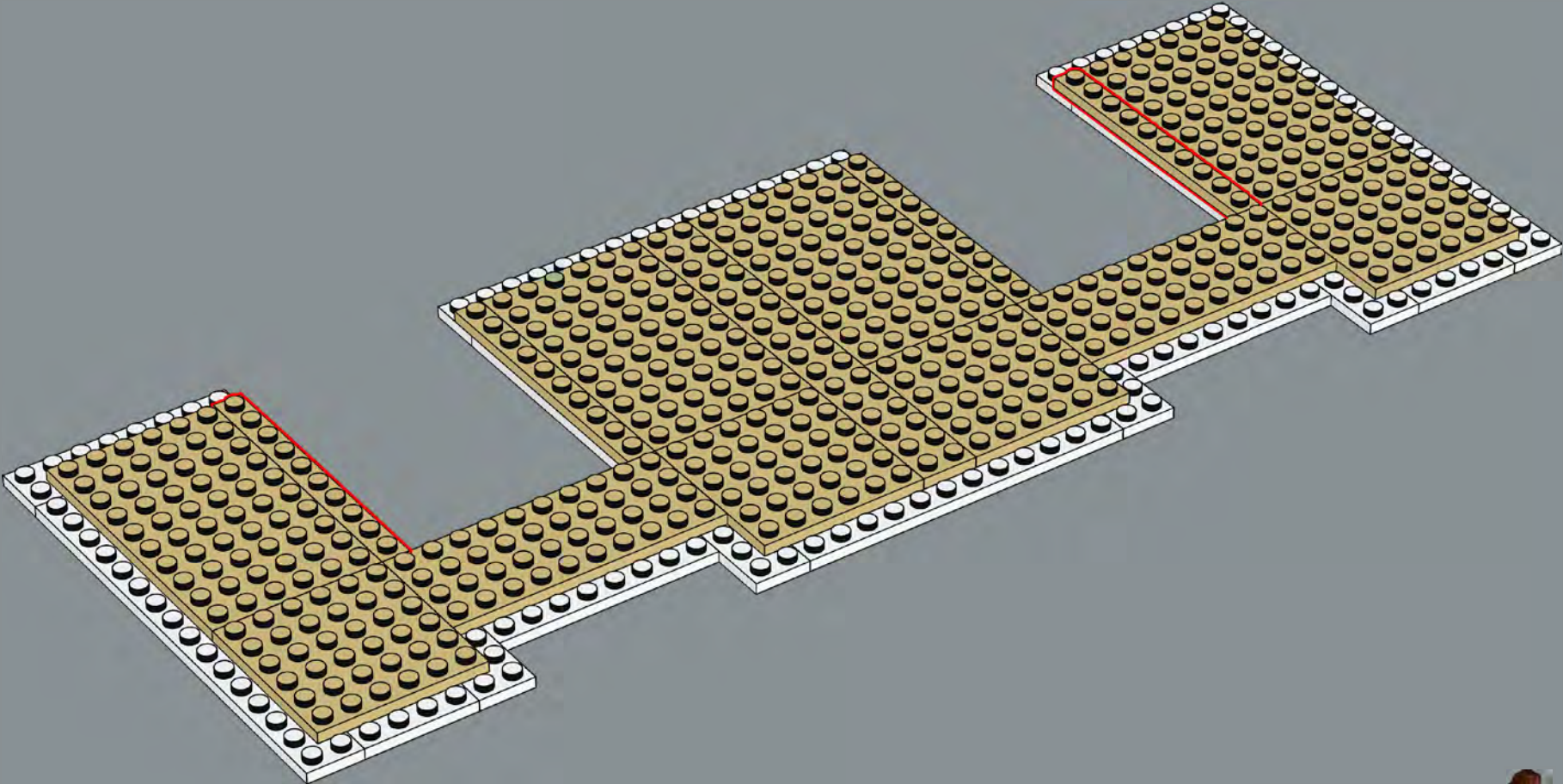

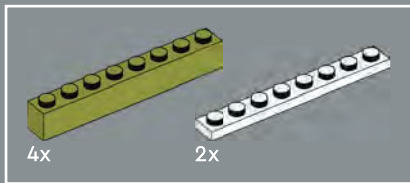

237

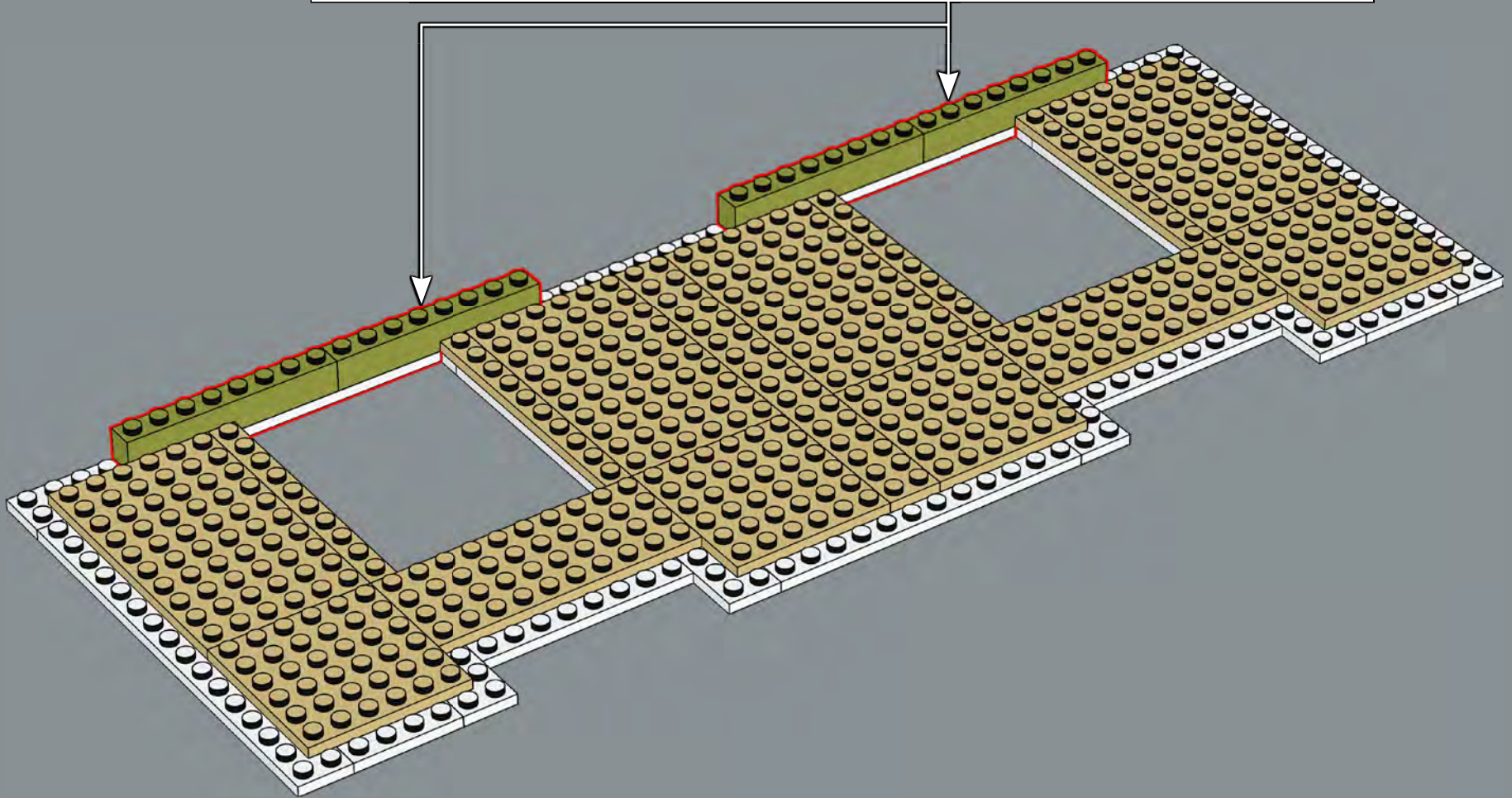
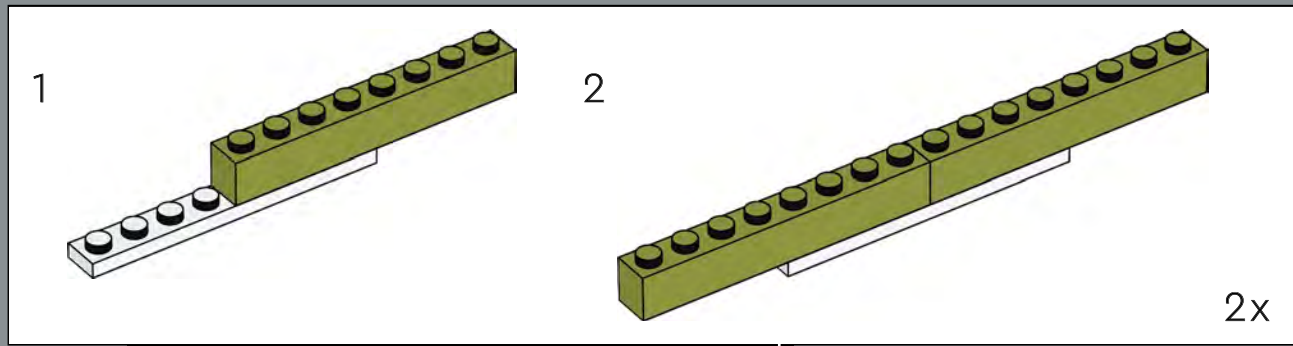

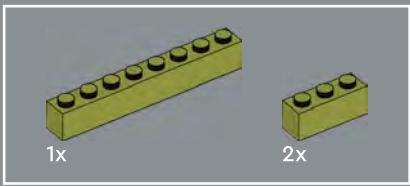

238

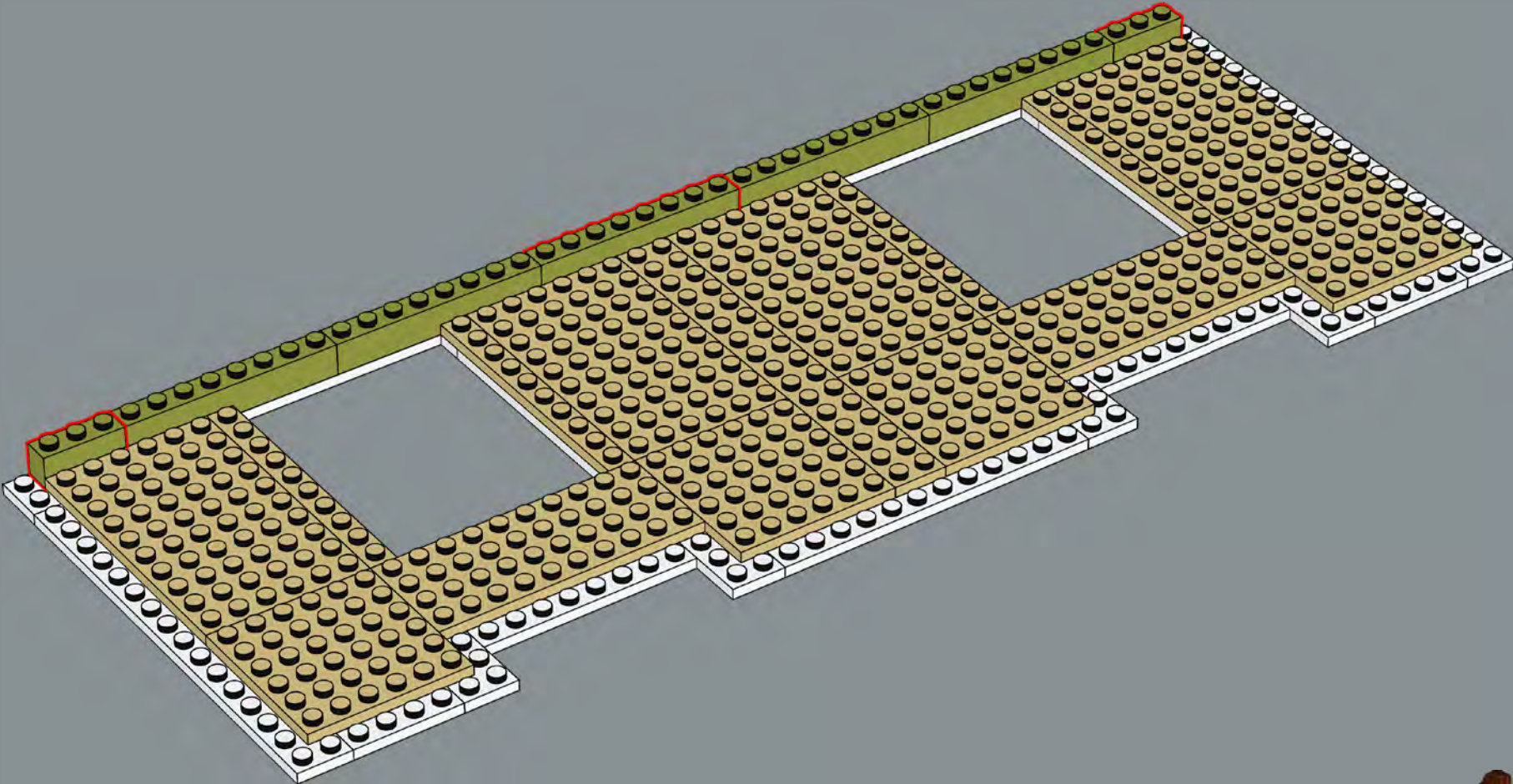

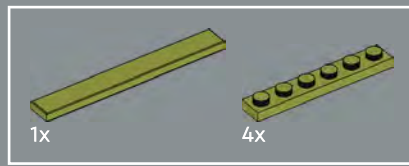

239

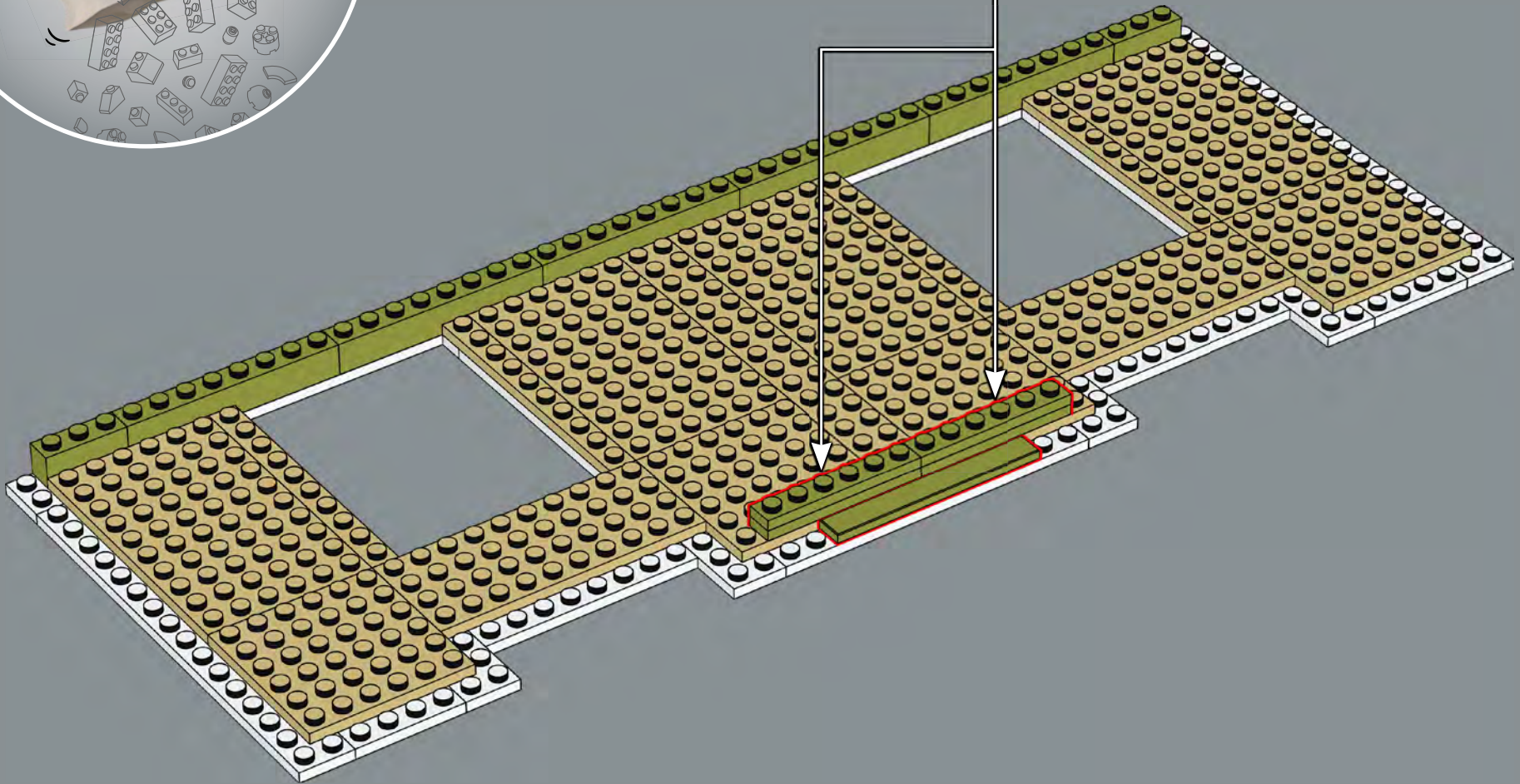
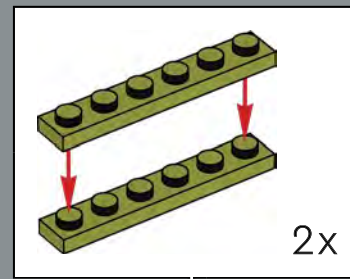

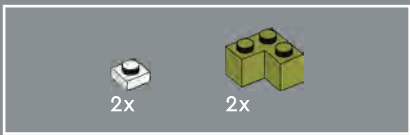

240

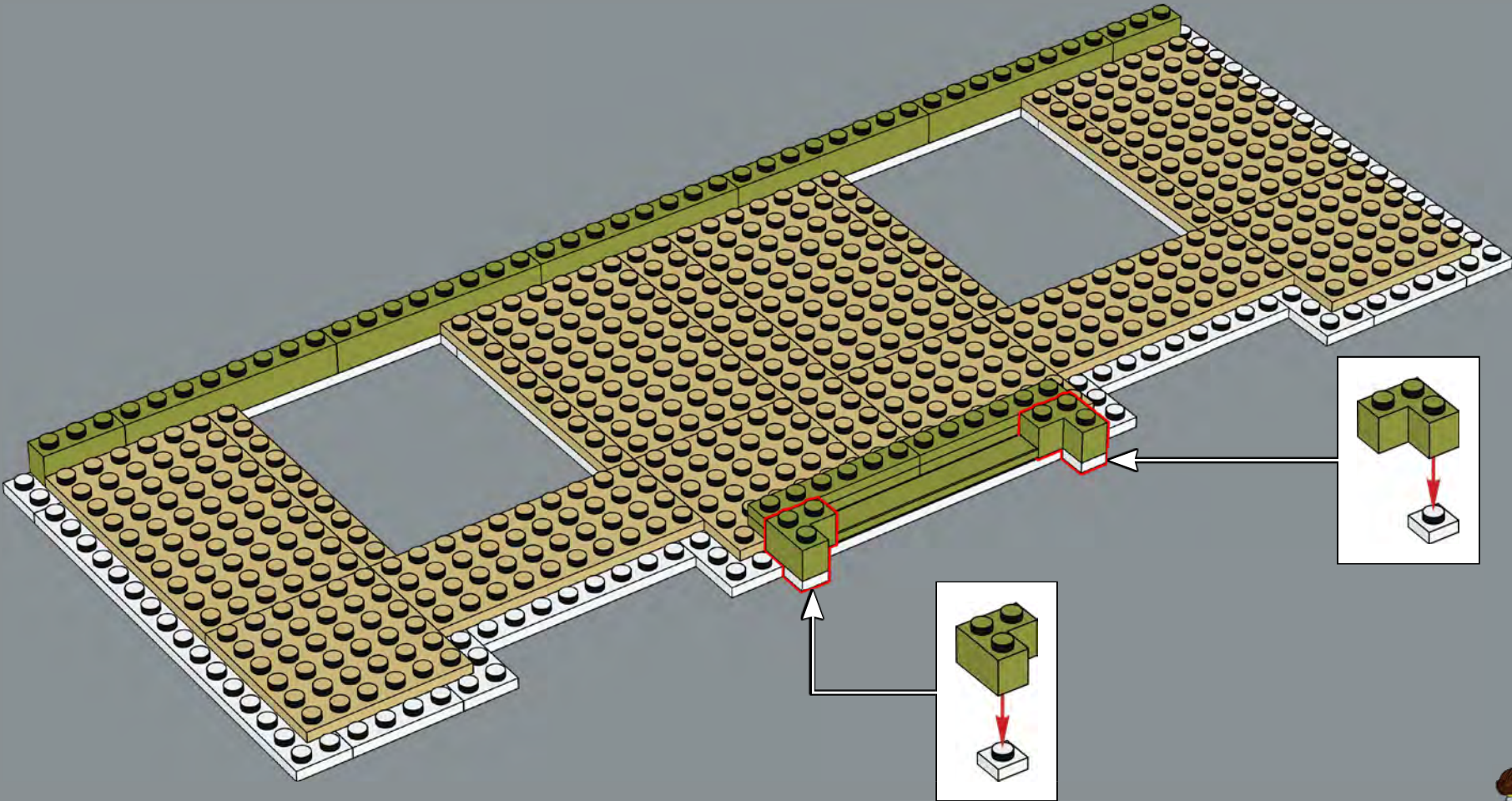

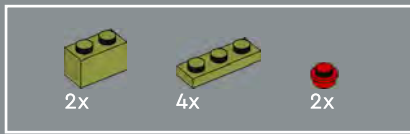

241

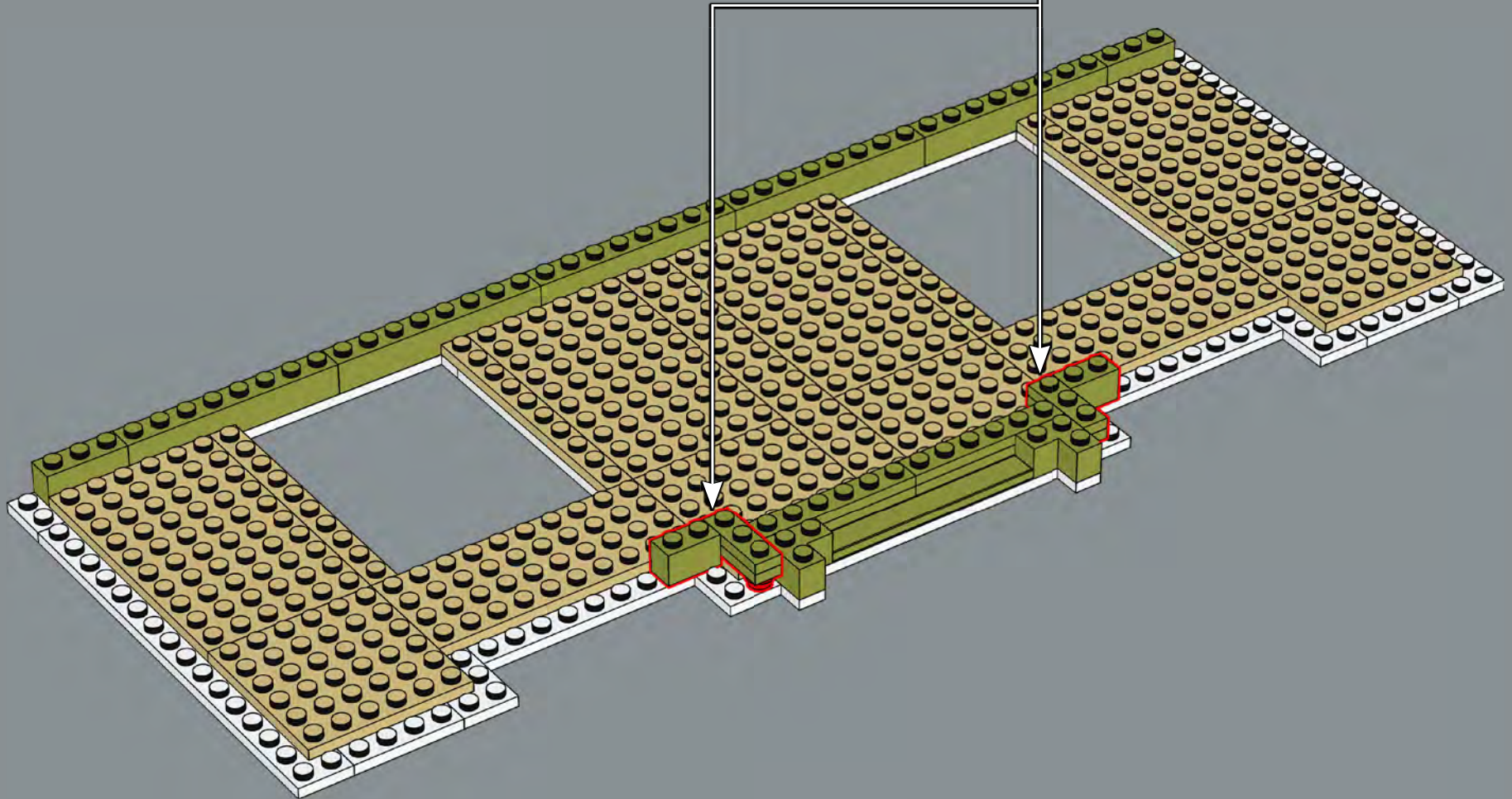
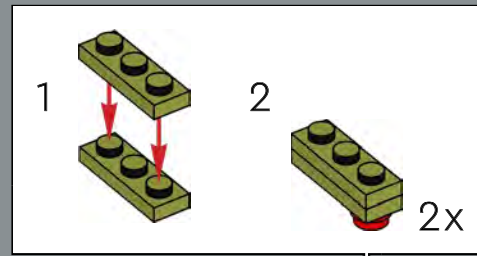

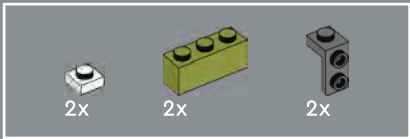

242

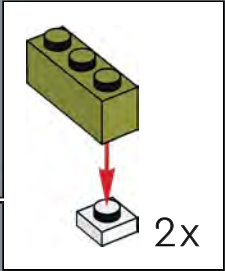
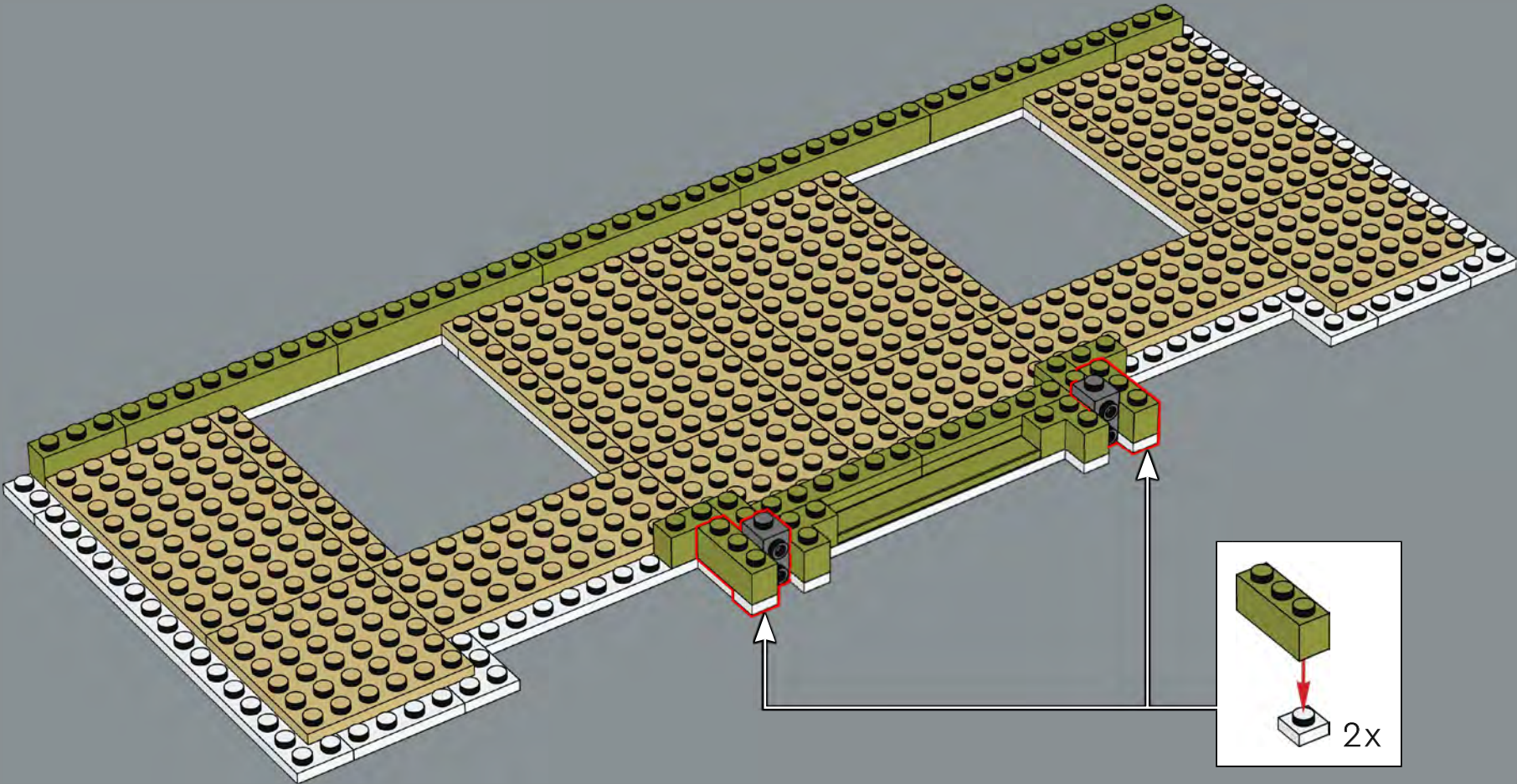

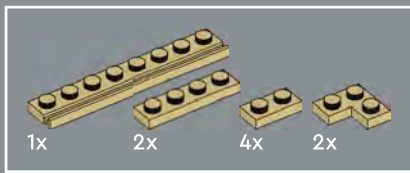

243

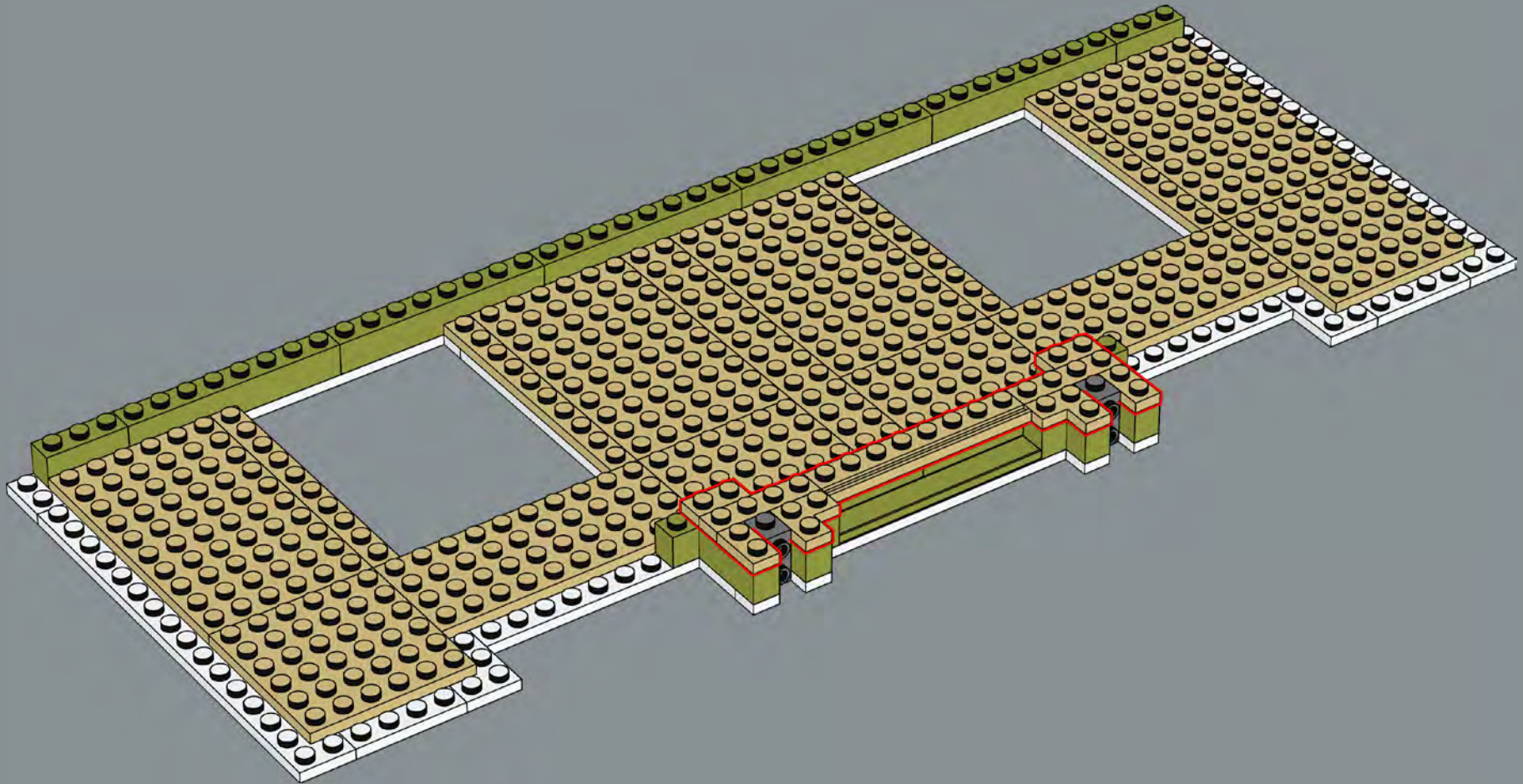

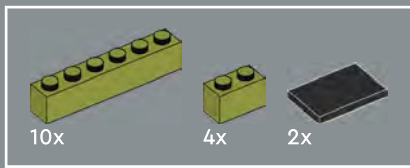

244

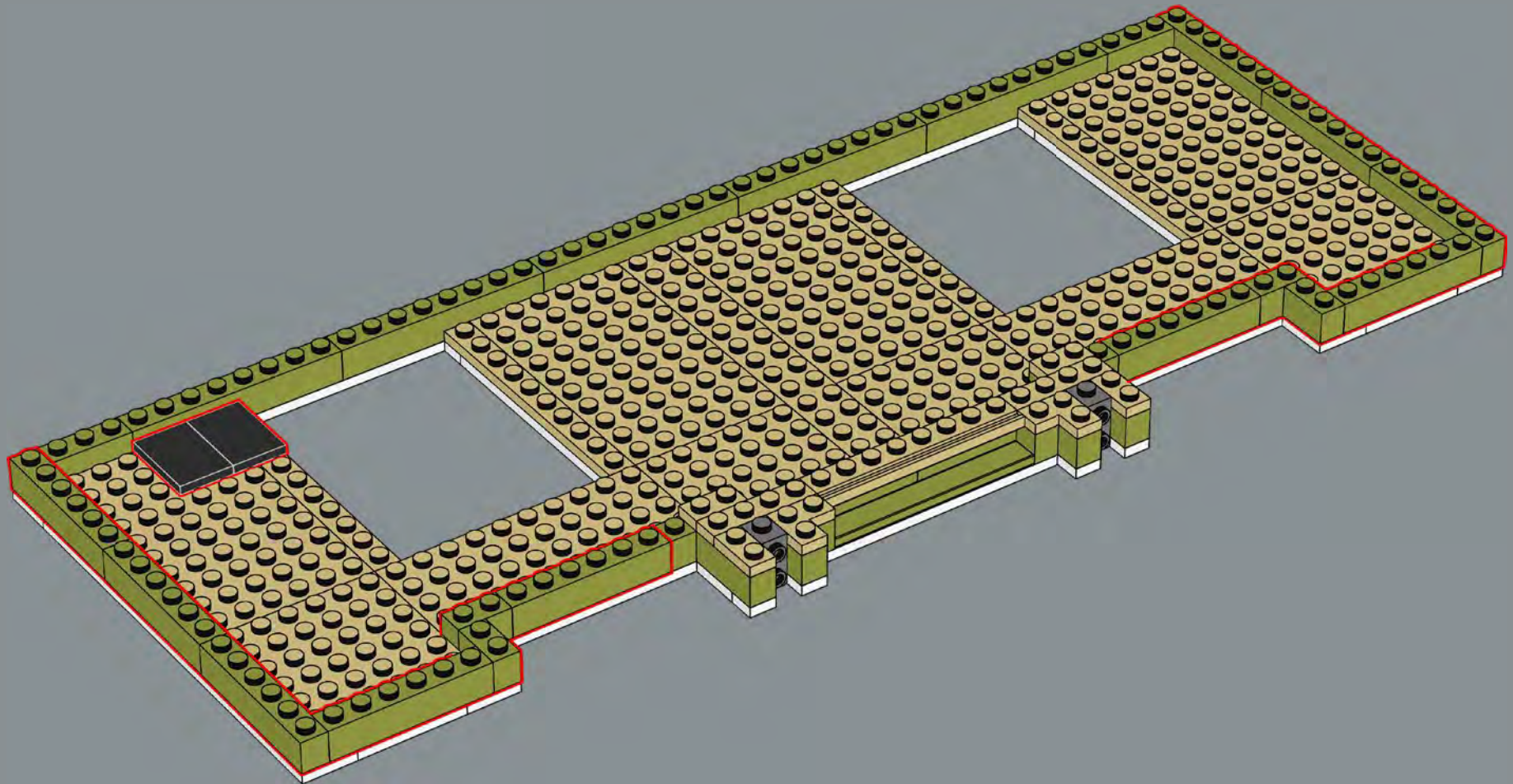



245

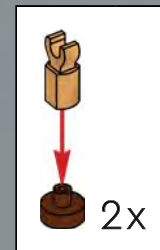
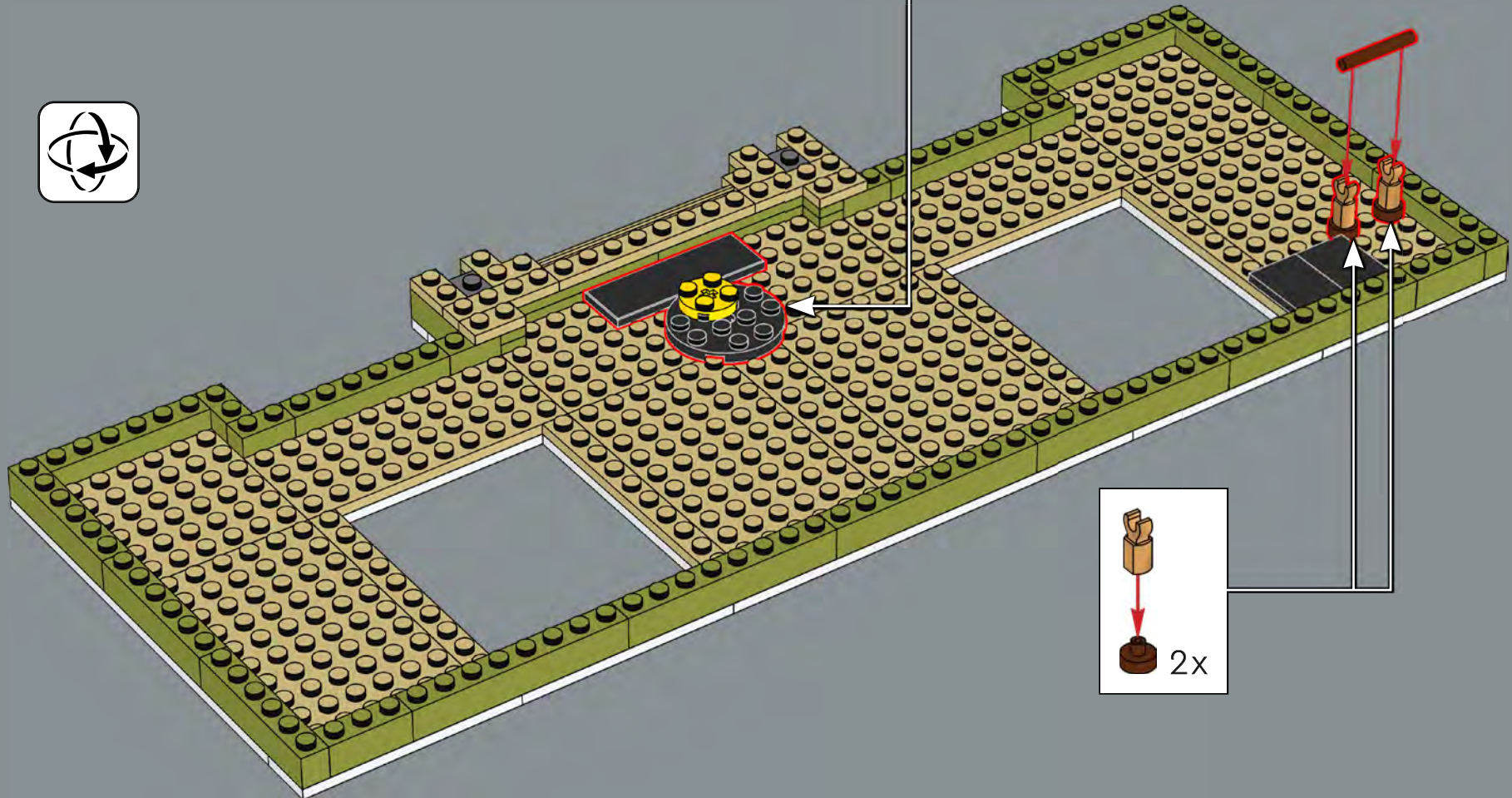

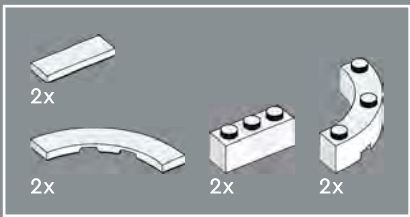

246

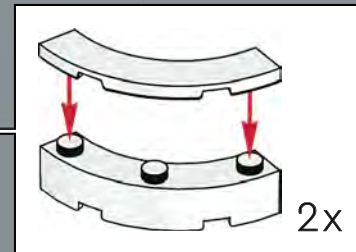
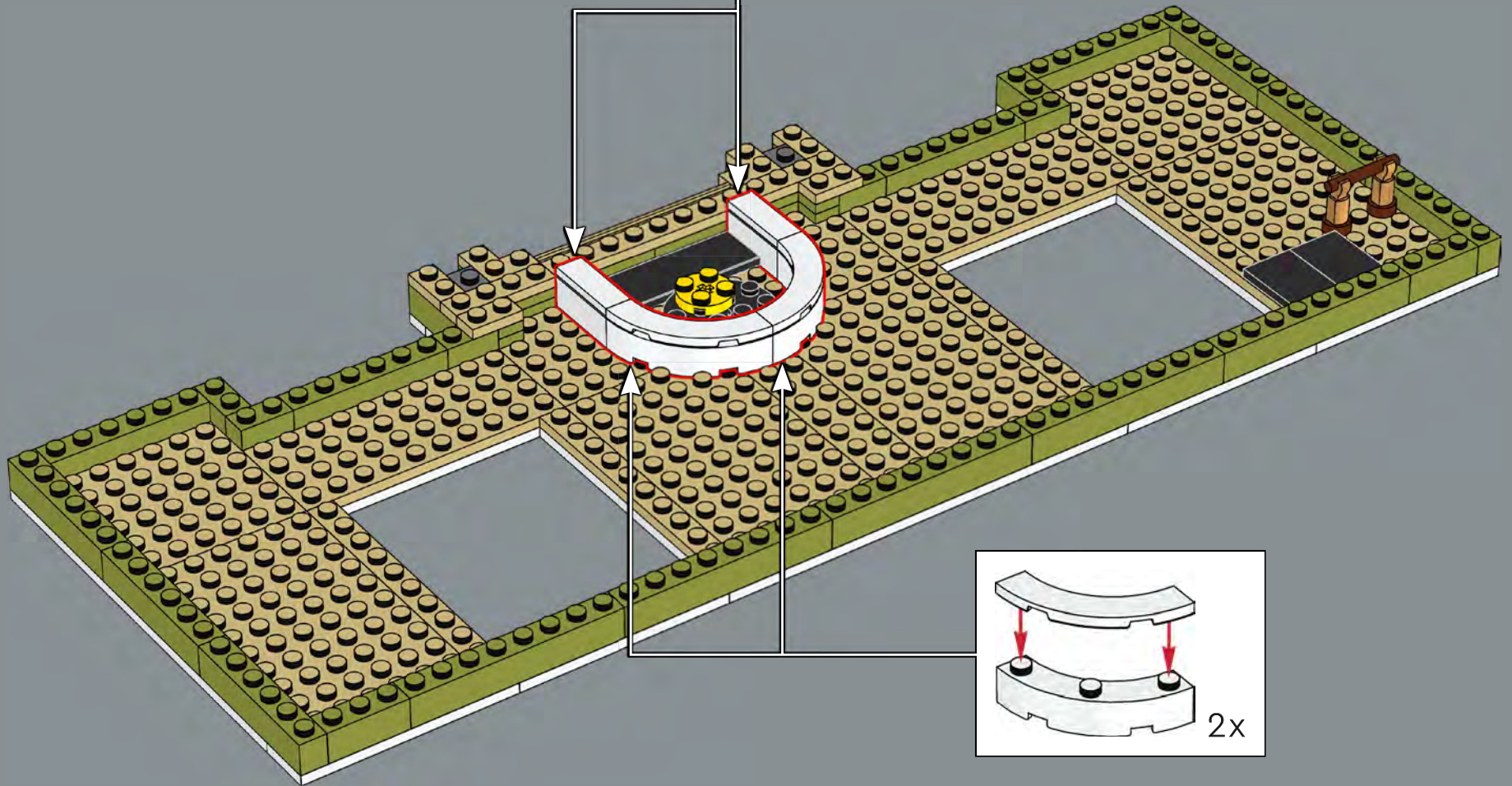
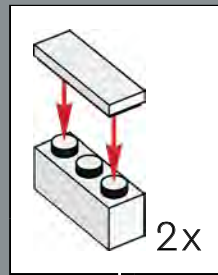



247

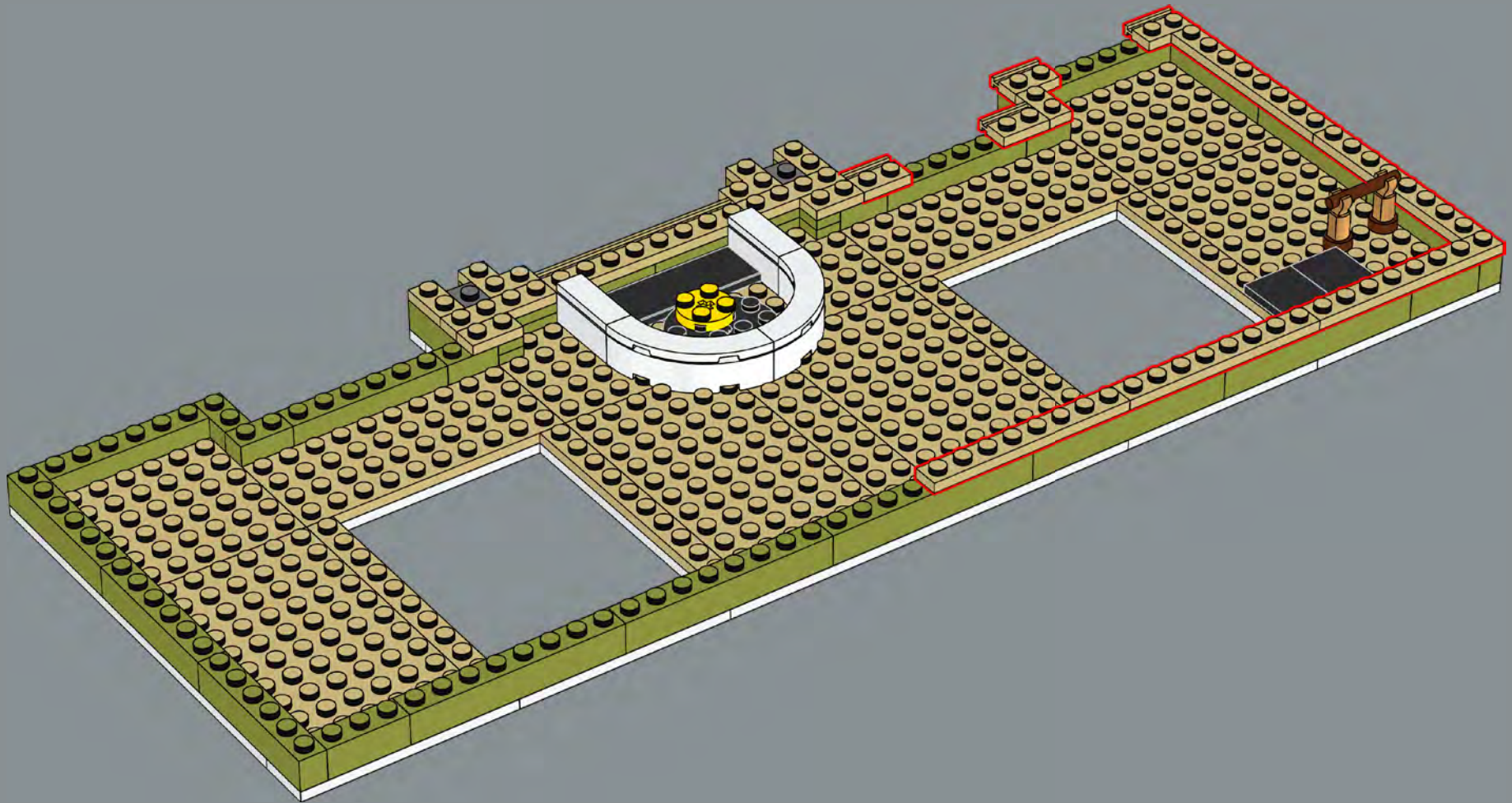



248

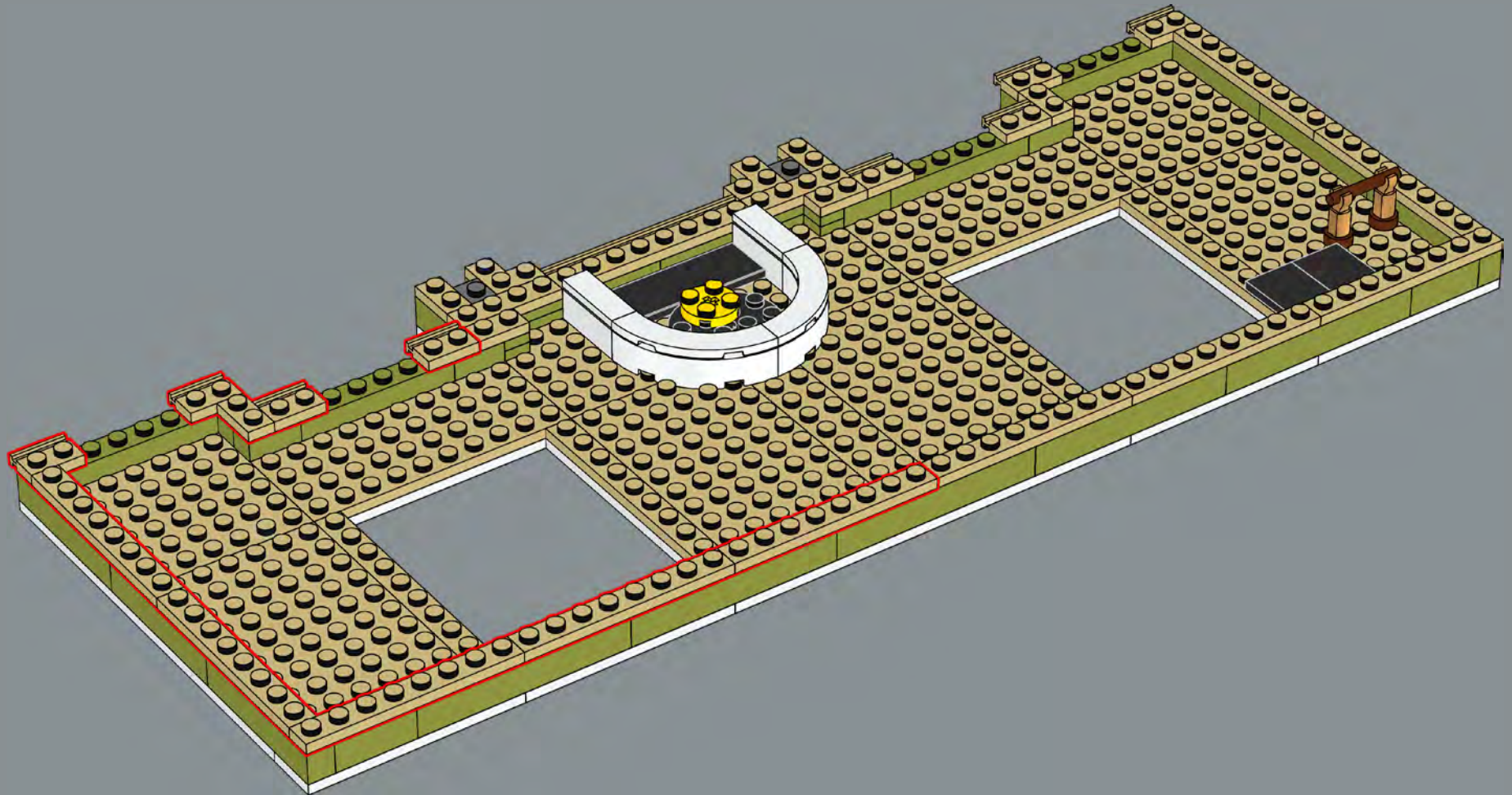



249

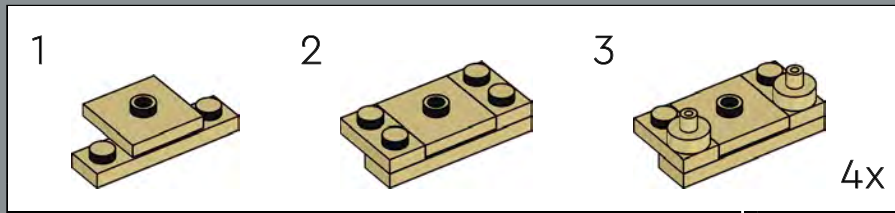

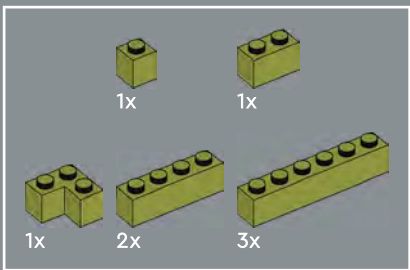

250

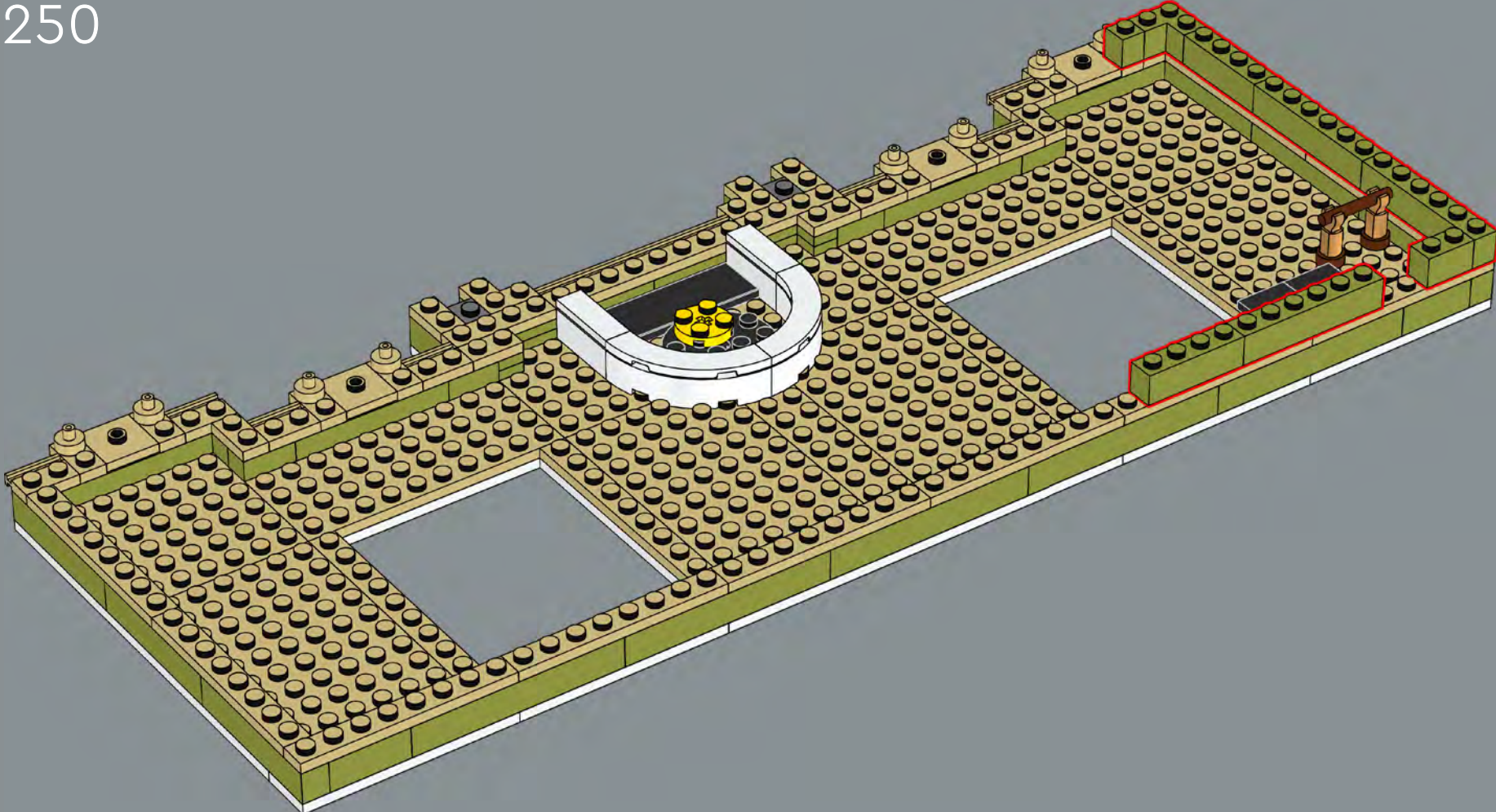

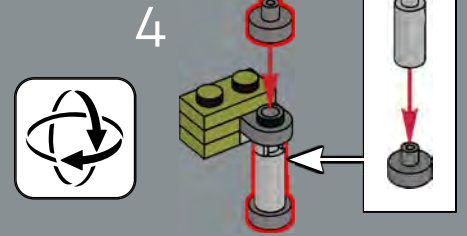
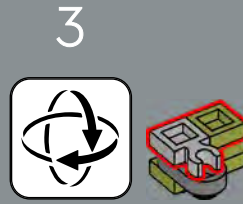
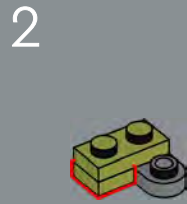
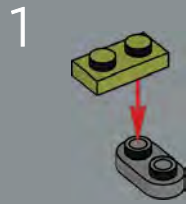
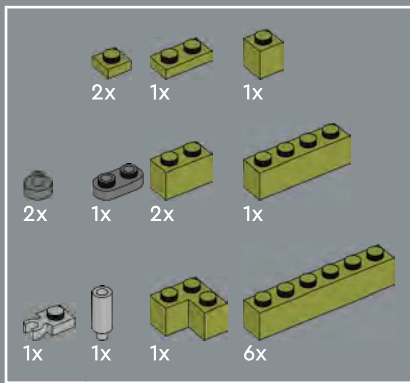

251

